



BOSCH

Control Panels

B6512/B5512/B4512/B3512

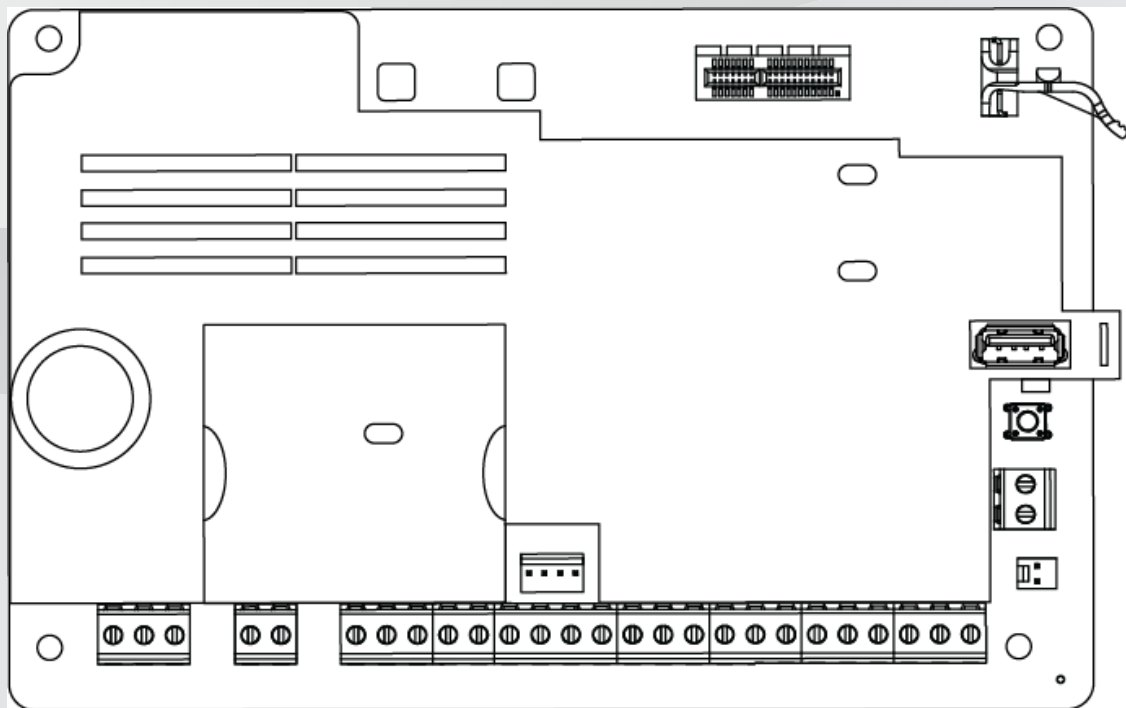

Table of contents

1	Certifications, approvals, listings, and safety	8
1.1	Listings and approvals	8
1.1.1	UL	8
1.1.2	ULC	8
1.1.3	Security Industry Association (SIA)	8
1.1.4	Department of Defense (DoD)	8
1.1.5	Department of Energy	8
1.1.6	California State Fire Marshal (CSFM)	8
1.1.7	National Institute of Standards and Technology (NIST)	8
1.1.8	Federal Communications Commission (FCC) Rules	9
1.1.9	Industry Canada (IC)	9
1.1.10	CE	9
1.2	Safety	10
1.2.1	Lightning	10
1.2.2	Power	10
2	Introduction	12
2.1	About documentation	12
2.1.1	Related documentation	12
2.2	Bosch Security Systems, Inc. product manufacturing dates	13
3	System overview	14
3.1	Parts list	14
3.2	Control panel capacities	14
4	Installation checklist	15
5	Control panel installation	16
5.1	Installing the enclosure and wiring label	16
5.2	Installing the control panel	16
5.2.1	Earth ground	18
5.2.2	OUTPUT A jumper	18
5.3	Control panel to module wiring overview	18
6	Power supply	20
6.1	Primary (AC) power	20
6.2	Secondary (DC) power	20
6.2.1	Install the battery	20
6.2.2	Battery maintenance	22
6.2.3	Battery supervision	22
6.2.4	Battery discharge and recharge schedule	22
6.3	B520 aux power supply	22
6.3.1	SDI2 address settings	23
6.3.2	Supervision	23
6.3.3	Auxiliary power supply trouble conditions	23
6.3.4	Installation and control panel wiring (B520)	23
6.3.5	Powered device and battery wiring	25
7	Telephone communications	28
7.1	B430 Plug-in Communicator, Telephone	28
7.1.1	Supervision	28
7.1.2	Installation and module wiring (B430)	28
7.1.3	Diagnostic LEDs	29
7.2	Phone jack location	29

7.3	Telephone line monitor	30
7.4	Called party disconnect	30
7.5	Communication failure	31
8	IP communications	32
8.1	On-board Ethernet connection	32
8.1.1	Supervision	32
8.1.2	Local programming	32
8.1.3	On-board Ethernet diagnostic LEDs	33
8.2	Conettix Plug-in cellular modules	34
8.3	B426 Ethernet Communication Module	34
8.3.1	Address and emulation settings	34
8.3.2	Supervision	34
8.3.3	B426 module faults	35
8.3.4	Installation and control panel wiring (B426)	35
8.3.5	Diagnostic LEDs	36
8.3.6	Local programming	38
8.4	B450 Conettix plug-in communicator interface	38
8.4.1	SDI2 address settings	38
8.4.2	Supervision	38
8.4.3	Installation and control panel wiring (B450)	38
8.4.4	Diagnostic LEDs	39
8.5	Compatible receivers for IP communication	40
9	Keypads, keyswitches, keyfobs and transmitters	42
9.1	Keypads	42
9.1.1	Keypads overview	42
9.1.2	B921C Two-line Capacitive Keypad with Inputs	44
9.1.3	Shortcuts and custom functions	44
9.1.4	Address settings	44
9.1.5	Supervision	44
9.1.6	Installation and control panel wiring (keypads)	44
9.1.7	Sensor loops overview and wiring (B921C/B942/B942W only)	45
9.1.8	Output wiring (B942/B942W only)	46
9.1.9	Troubleshooting	46
9.2	Keyswitches	46
9.2.1	Operation	47
9.2.2	Installation and control panel wiring (keyswitches)	47
9.3	RADION keyfobs and Inovonics pendant transmitters	48
10	On-board outputs	49
10.1	Circuit protection	49
10.2	Total available power	49
10.3	Open collector outputs	50
11	Off-board outputs	51
11.1	B308 octo-output module	51
11.1.1	SDI2 address settings	51
11.1.2	Supervision	51
11.1.3	Installation and control panel wiring (B308)	52
12	On-board points	54
12.1	Point sensor loops	54
12.1.1	Single EOL (and no EOL) resistor circuit style	54

12.1.2	Dual EOL resistor circuit style	55
12.2	Point response time	56
13	Off-board points	57
13.1	B208 octo-input module	57
13.1.1	SDI2 address settings	57
13.1.2	Supervision	57
13.1.3	Installation and control panel wiring (B208)	57
13.1.4	Sensor loops overview and wiring	59
13.2	Off-board points test	61
13.3	Extra Point events	61
13.4	Missing point conditions	61
14	Wireless modules	62
14.1	B810 receiver	62
14.1.1	SDI2 address settings	62
14.1.2	Supervision	62
14.1.3	Installation and control panel wiring (B810)	62
14.2	B820 SDI2 Inovonics Interface Module	63
14.2.1	SDI2 address settings	63
14.2.2	Supervision	64
14.2.3	Installation and control panel wiring (B820)	64
15	Access control	66
15.1	B901 door controller	66
15.1.1	Address settings	66
15.1.2	Supervision	66
15.1.3	Installation and control panel wiring (B901)	67
15.2	Card reader wiring	68
16	Program and test the control panel	69
16.1	Program the control panel	69
16.1.1	Program the control panel with RPS	69
16.1.2	Program the control panel with the Installer Services Portal programming tool	70
16.1.3	Program the control panel with a keypad	70
16.2	Walk tests	70
16.2.1	Fire walk test	70
16.2.2	Intrusion walk test	71
16.2.3	Service walk test	71
16.2.4	Invisible walk test	72
17	Control panel board overview	73
18	System wiring diagrams	75
18.1	System wiring overview	75
18.2	Battery lead supervision wiring	76
18.3	2-wire smoke wiring (B201)	77
18.4	2-wire smoke wiring (D125B)	78
18.5	Notification appliance circuit wiring	79
18.6	SDI2 devices general system wiring	80
18.6.1	SDI2 bus wiring recommendations	81
18.7	Wiring label	83
19	Approved applications	84
19.1	Optional compatible equipment	84
19.1.1	Burglar applications	84

19.1.2	Bank safe and vault applications	84
19.1.3	Fire applications	88
19.1.4	Enclosures	90
19.2	Combination fire and intrusion alarm systems	91
19.3	Compatible UL listed components	91
19.4	Standby battery requirements and calculations	93
19.4.1	Household Fire Warning equipment	95
19.5	UL 365 - Police Station Connected Burglar Alarm Units and Systems	95
19.6	UL 636 - Holdup Alarm Units and System	96
19.7	Required values to achieve 180s (ULC)/200s (UL) supervision interval	96
19.8	ULC	96
20	Keypad Installer menu	97
20.1	[1] Program menu (Programming)	103
20.1.1	[1] Reporting > [1] Phone menu parameters	103
20.1.2	[1] Reporting > [2] Network menu parameters	104
20.1.3	[1] Reporting > [3] Report Routing parameters	106
20.1.4	[1] Reporting > [4] Personal Note menu parameters	107
20.1.5	[2] Network > [1] Ethernet > (choose the bus module or on-board) > [1] Module Parameters menu	108
20.1.6	[2] Network > [1] Ethernet > (choose the bus module or on-board) > [2] Address Parameters menu	109
20.1.7	[2] Network > [1] Ethernet > (choose the bus module or on-board) > [3] DNS Parameters menu	110
20.1.8	[2] Network > [2] Cellular > (choose the SDI2 cellular module or plug-in module)	110
20.1.9	[3] RPS > [1] RPS Passcode menu parameters	111
20.1.10	[3] RPS > [2] RPS Phone Number menu parameters	112
20.1.11	[3] RPS > [3] RPS IP Address menu parameters	112
20.1.12	[3] RPS > [4] RPS Port Number menu parameters	112
20.1.13	[4] Area Options menu parameters	113
20.1.14	[5] Keypad menu parameters	114
20.1.15	[6] Users menu parameters	115
20.1.16	[7] Points menu parameters	116
20.1.17	[8] Disable Programming menu	122
20.2	[2] Wireless menu	123
20.2.1	[1] RF Point Menu> [1] Enroll Point RFID	123
20.2.2	[1] RF Point Menu> [2] Replace Point RFID	123
20.2.3	[1] RF Point Menu> [3] Remove Point RFID	123
20.2.4	[2] RF Repeater Menu > [1] Add Repeater	124
20.2.5	[2] RF Repeater Menu > [2] Replace Repeater	124
20.2.6	[2] RF Repeater Menu > [3] Remove Repeater	124
20.2.7	[3] RF Diagnostic Menu > [1] RF Points	124
20.2.8	[3] RF Diagnostic Menu > [2] RF Repeater Menu	125
20.3	[3] Diags menu	125
20.3.1	[1] Wireless	125
20.3.2	[2] Network menu	126
20.3.3	[3] Cellular menu	126
20.3.4	[4] IP Camera	126
20.3.5	[5] Cloud	127
20.4	[4] Service Bypass (Serv Byp) menu	127

20.5	[5] Versions menu	127
20.6	[6] Cloud menu	128
21	Specifications	129
21.1	Wire requirements	130
22	Appendix	132
22.1	Address settings	132
22.1.1	B208 address settings	132
22.1.2	B308 address settings	132
22.1.3	B901 address settings	133
22.1.4	B91x address settings	133
22.2	Reporting and device number information	134
22.2.1	Report format definitions	134
22.2.2	SDI2 address information	143
22.2.3	Device numbers (zzz, dddd)	144
22.2.4	Communication Trouble device numbers (zzzz)	144
22.2.5	Special User IDs (uuuu, iiiii)	145
22.2.6	Keypad alarm virtual point numbers (ppp, pppp)	145
22.3	AutoIP	146

1 Certifications, approvals, listings, and safety

This section provides certification and approval listings and safety information.

1.1 Listings and approvals

This document includes the section *Approved applications, page 84*. Refer to this section for guidelines on installing the control panels in Underwriters Laboratories Inc. (UL) and fire-specific applications.

1.1.1 UL

Listed for:

- UL 365 - Police Station Connected Burglar Alarm Units and Systems
- UL 609 - Local Burglar Alarm Units and Systems
- UL 636 - Holdup Alarm Units and Systems
- UL 985 - Household Fire Warning System Units
- UL 1023 - Household Burglar Alarm System Units
- UL 1076 - Proprietary Burglar Alarm Units and Systems
- UL 1610 - Central Station Burglar Alarm Units
- UL 1635 - Digital Alarm Communicator System Units

1.1.2 ULC

Listed for:

- ULC C1023 - Household Burglar Alarm System Units
- ULC C1076 - Proprietary Burglar Alarm Units and System
- ULC S303 - Local Burglar Alarm Units and System
- ULC S304 - Central and Monitoring Station Burglar Alarm Units
- ULC S545 - Residential Fire Warning System Control Units
- ULC S559 - Fire Signal Receiving Centres and Systems

1.1.3 Security Industry Association (SIA)

Listed for Control Panel Standard - Features for False Alarm Reduction ANSI/SIA CP-01-2010.

1.1.4 Department of Defense (DoD)

The B6512/B5512/B4512/B3512 control panels were granted approval for Department of Defense (DoD) installations in Sensitive Compartmented Information Facilities (SCIF).

1.1.5 Department of Energy

This control panel operates on a transformer that has been reviewed by a third party and deemed to be compliant to the Department of Energy, U.S. Energy Conservation Standard for External Power Supplies (found in section 10 CFR 430.32(w)(1)(i) of the Federal Code) as an indirect device.

1.1.6 California State Fire Marshal (CSFM)

Listed for Household Fire Alarm.

1.1.7 National Institute of Standards and Technology (NIST)

When communicating via a network, listed for Advanced Encryption Standard (AES), Federal Information Processing Standards Publication 197 (FIPS 197).

1.1.8

Federal Communications Commission (FCC) Rules

Part 15

This equipment was tested and found to comply with the limits for a Class B digital device, pursuant to Part 15 of the FCC rules. These limits are designed to provide reasonable protection against harmful interference when the equipment is operated in a commercial environment.

This equipment generates, uses, and can radiate radio frequency energy; and if not installed and used according to the instructions, can cause harmful interference to radio communications.

Operation of this equipment in a residential area is likely to cause harmful interference, in which case the user is required to correct the interference at his or her own expense.

Part 68

The B430 module by Bosch Security Systems, Inc. is registered with the Federal Communication Commission (FCC) under Part 68, for connection to the public telephone system using an RJ31X or RJ38X phone line connection jack installed by the local telephone company.

Do not connect registered equipment to party lines or coin-operated telephones. Notify the local telephone company and provide the following information before connecting the control panel to the telephone network:

- The particular line to which you connect the module
- Make (Bosch Security Systems, Inc.), model (B6512/B5512/B4512/B3512), and serial number of the control panel
- FCC registration number: ESVAL00BB430
- Ringer eq: 0.0B

1.1.9

Industry Canada (IC)

ICES-003 - Information Technology Equipment

This Class B digital equipment meets all requirements of the Canadian interference-causing equipment regulations.

Cet appareil numérique de la Class A respecte toutes les exigences de règlement sur le matériel brouilleur du Canada.

CS-03 - Compliance Specification for Terminal Equipment

The B430 module by Bosch Security Systems, Inc. meets the applicable Industry Canada technical specifications. The Ringer Equivalence Number (REN) is an indication of the maximum number of devices allowed to be connected to a telephone interface. The termination of an interface may consist of any combination of devices subject only to the requirement that the sum of the RENs of all the devices not exceed five.

Le présent matériel est conforme aux spécifications techniques applicables d'Industrie Canada.

L'indice d'équivalence de la sonnerie (IES) sert à indiquer le nombre maximal de terminaux qui peuvent être raccordés à une interface téléphonique. La terminaison d'une interface peut consister en une combinaison quelconque de dispositifs, à la seule condition que la somme d'indices d'équivalence de la sonnerie de tous les dispositifs n'excède pas cinq.

1.1.10

CE

Listed for:

- EMC
- LVD
- RoHS

1.2 Safety



Notice!

After system installation and any control panel programming, perform a complete system test. A complete system test includes testing the control panel, all devices, and communication destinations for proper operation.

1.2.1

Lightning

The control panel design significantly reduces the adverse effects of lightning. Take installation precautions to further reduce these adverse effects.

Effects of lightning

Electronics involved in a direct lightning strike or near a lightning strike can show adverse effects. When lightning strikes, several things happen:

- An electromagnetic wave spreads from the center point of the strike inducing high voltages onto nearby conductors.
- The voltage changes substantially on electrical grounds near the lightning strike.
- High voltages are induced onto anything directly struck by lightning.

The effects of lightning can include trouble events, alarm events, and physical damage.

Installation precautions

To minimize the undesirable effects from lightning:

- Do not run wiring outside the building.
- If you install the unit in a metal building, keep the wiring at least 2 ft (0.61 m) away from external metal surfaces. Make a proper earth ground connection.
- Earth ground the unit correctly. Do not use an electrical ground or telephone ground.
- Avoid running wires near telephone, data, or power lines. Locating control panel wiring at least 2 ft (0.61 m) away helps reduce the effects of lightning.
- When your data lines must cross the path of AC or other wiring, cross perpendicular to the lines.

Warranty regarding lightning

The warranty does not cover physical damage due to lightning.

1.2.2

Power



Caution!

Remove all power (AC and battery) before making any connections. Failure to do so might result in personal injury and/or equipment damage.



Caution!

Do not short-circuit the terminals of the transformer

If you short the terminals, the internal fuse opens. This causes permanent failure. Connect the transformer to the control panel AC power terminals before you plug it into the power source.



Notice!

Plan ahead

Route telephone, SDI2 bus wiring, and sensor loop wiring away from any AC conductors, including the transformer wire. AC wiring can induce noise and low level voltage into adjacent wiring.

**Warning!****High current arcs are possible**

The positive (red) battery lead and the terminal labeled BAT+ can create high current arcs if shorted to other terminals or the enclosure. Use caution when you touch the positive lead and the terminal labeled BAT+. Always disconnect the positive (red) lead from the battery before you remove it from the terminal labeled BAT+.

**Caution!****Battery terminals and wire are not power limited**

Maintain a 0.250 in (6.4 mm) space between the battery terminals, battery wiring, and all other wiring. Battery wiring cannot share the same conduit, conduit fittings, or conduit knockouts with other wiring.

**Caution!****Heavy discharges possible**

The system can have heavy discharges if you exceed the maximum output ratings or install the transformer in an outlet that is routinely switched off. Routine heavy discharges can lead to premature battery failure.

**Notice!****Use sealed lead acid batteries only**

The charging circuit is calibrated for lead-acid batteries. Do not use gel-cell or NiCad batteries.

2 Introduction

This section includes an introduction to documents for this product and other document-related instructions.

2.1 About documentation

This document has instructions for a trained installer to install, configure, and operate this control panel, and optional peripheral devices.

(Bosch Security Systems, Inc. recommends that installers follow good wiring practices such as those described in NFPA 731, Standard for the Installation of Electronics Premises Security Systems.)

Throughout this document, the words “control panel” refer to all control panels covered by this document (B6512/B5512/B4512/B3512).

Notifications

This document uses Notices, Cautions, and Warnings to draw your attention to important information.



Notice!

These include important notes for successful operation and programming of equipment, or indicate a risk of damage to the equipment or environment.



Caution!

These indicate a hazardous situation which, if not avoided, could result in minor or moderate injury.



Warning!

These indicate a hazardous situation which, if not avoided, could result in death or serious injury.

Copyright

This document is the intellectual property of Bosch Security Systems B.V. and is protected by copyright. All rights reserved.

Trademarks

All hardware and software product names used in this document are likely to be registered trademarks and must be treated accordingly.

2.1.1

Related documentation

Control panel documents

Control Panels (B6512/B5512/B4512/B3512) Release Notes*
Control Panels (B6512/B5512/B4512/B3512) Installation Manual [†]
Control Panels (B9512G/B8512G/B6512/B5512/B4512/B3512) Operation Manual* [†]
Control Panels (B5512/B4512/B3512) Program Entry Guide [†]
Control Panel (B6512) Program Entry Guide
Control Panels (B6512/B5512/B4512/B3512) UL Installation Manual* [†]

Control Panels (B6512/B5512/B4512/B3512) SIA Quick Reference Guide* +
Control Panels (B9512G/B8512G/B6512/B5512/B4512/B3512) ULC Installation Manual*
*Shipped with the control panel.
*Located on the documentation CD shipped with the control panel.

Keypad documents

Basic Keypad (B915) Installation Guide*
Two-line Alphanumeric Keypad (B920) Installation Guide*
Two-line Capacitive Keypad with Inputs (B921C) Installation Guide*
ATM Style Alphanumeric Keypad (B930) Installation Guide*
B940W Touch screen KP, White Quick installation guide*
Touch Screen Keypad (B942/B942W) Installation Guide*
*Shipped with the keypad.

Optional module documents

2-wire Powered Loop Module (B201) Installation and Operation Guide*
Octo-input Module (B208) Installation and Operation Guide*
Octo-output Module (B308) Installation and Operation Guide*
Conettix Ethernet Communication Module (B426) Installation and Operation Guide* +
Plug-in Telephone Communicator (B430) Installation Guide Installation Guide*
Conettix Plug-in GPRS Cellular Communicator (B442) Installation and Operation Guide*
Conettix Plug-in HSPA+ Cellular Communicator (B443) Installation and Operation Guide*
Conettix Cellular Communicators B44x Installation Manual
B444-A B444-V Quick installation guide*
Conettix Plug-in Communicator Interface (B450) Installation and Operation Guide* +
Auxiliary Power Supply (B520) Installation and Operation Guide*
RADION receiver SD (B810) Installation Guide*
SDI2 Inovonics Interface Module (B820) Installation Guide*
*Shipped with the module.
*Located on the documentation CD shipped with the module.

2.2

Bosch Security Systems, Inc. product manufacturing dates

Manufacturing dates

For product manufacturing dates, go to <http://www.boschsecurity.com/datecodes/> and refer to the serial number located on the product label.

3 System overview

This section has the following information:

- *Parts list, page 14*
- *Control panel capacities, page 14*
- Accessories
- Features

3.1 Parts list

Control panels ship assembled from the factory with the following parts:

Literature

- Control Panels (B6512/B5512/B4512/B3512) UL Installation Manual
- Control Panels (B6512/B5512/B4512/B3512) Operation Manual
- Control Panels (B6512/B5512/B4512/B3512) SIA Quick Reference Guide
- Control Panels (B6512/B5512/B4512/B3512) Documentation CD
- Enclosure Wiring Label (B6512/B5512/B4512/B3512)

HW pack

- Mounting clips
- 1 k Ω EOL resistors
- Battery wires
- Four #6 x 3/4 in self threading screws

Assembly

- PC board

3.2 Control panel capacities

Features	B6512	B5512	B4512	B3512
Number of users	100	50	32	10
Number of custom functions	6	4	2	1
Number of areas	6	4	2	1
Number of points	96	48	28	16
Number of outputs	91	43	27	3
Number of keypads	12	8	8	4
Number of doors	4	0	0	0
Number of octo-input modules (B208)	9	4	2	0
Number of octo-output modules (B308)	9	5	3	0
Number of on-board Ethernet ports	1	1	1	1
Number of B426 or B450 modules	1	1	1	1
Number of plug-in modules (B430, B442/B443/B444-A/B444-V)	1	1	1	1
Number of auxiliary power supply modules (B520)	4	4	2	2
Number of wireless receivers (B810/B820)	1	1	1	1

4 Installation checklist

Before you install and operating the control panel, read these instructions. If you do not read and understand these instructions, you cannot properly install and operate the control panel. The instructions do not remove the need for training by authorized personnel.

Install, operate, test, and maintain this device according to the control panel Installation and System Reference Guide. Failure to follow these procedures may cause the device not to function properly. Bosch Security Systems Inc. is not responsible for any devices that are improperly installed, tested, or maintained.

The control panel Installation and System Reference Guide does not have special information about local requirements and safety issues. Information on such issues is provided only to the extent that it is needed for operation of the device. Make sure that you are familiar with all safety-related processes and regulations in your area. This also includes how to act in the event of an alarm and the initial steps to take if a fire breaks out. The operating instructions should always be available on site. It is a required part of the system and must be given to the new owner if the system is ever sold.

Install the enclosure and wiring label

- *Installing the enclosure and wiring label, page 16*

Install the control panel

- Mount the control panel
- *Earth ground, page 18*
- *OUTPUT A jumper, page 18*

Install and wire for telephone communication

- *Telephone communications, page 28*

Install and wire for IP communications

- *IP communications, page 32*

Install and wire the battery and the transformer

- *Power supply, page 20*

Begin to charge the battery while you install other devices

- Charge the battery

Install and wire arming devices

- *Keypads, keyswitches, keyfobs and transmitters, page 42*

Install and wire outputs

- *On-board outputs, page 49*
- *Off-board outputs, page 51*

Install and wire inputs

- *On-board points, page 54*
- *Off-board points, page 57*
- *Wireless modules, page 62*

Complete the installation

- *Program and test the control panel, page 69*

5 Control panel installation

Refer to *Enclosures*, page 90 to determine if the application requires a specific enclosure.

Enclosure overview

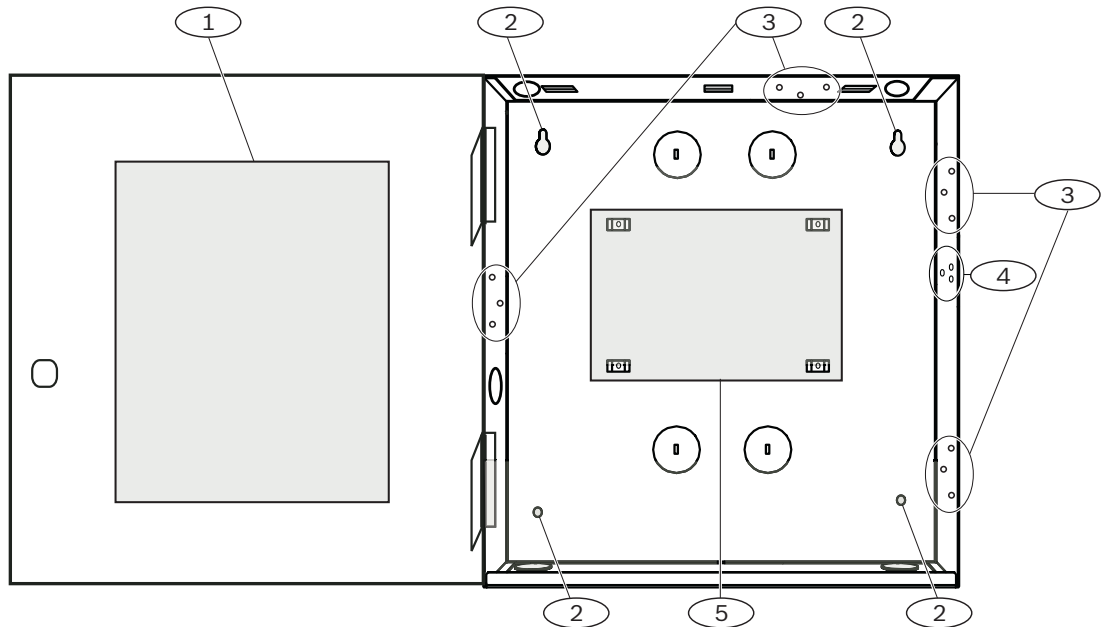

Callout — Description
1 — Control panel wiring label
2 — Enclosure mounting holes (4)
3 — Three-hole pattern for mounting modules (4)
4 — Mounting location for the tamper switch
5 — Mounting location for the control panel

5.1 Installing the enclosure and wiring label



Notice!

Electromagnetic interference (EMI)

EMI can cause problems on long wire runs.

1. Remove the knockouts.
2. Mount the enclosure. Use all enclosure mounting holes. Refer to the mounting instructions supplied with the selected enclosure.
3. Pull the wires into the enclosure through the knockouts.
4. Position the supplied enclosure wiring label on the inside of the enclosure door.

5.2 Installing the control panel

1. Identify the control panel mounting location in the enclosure.

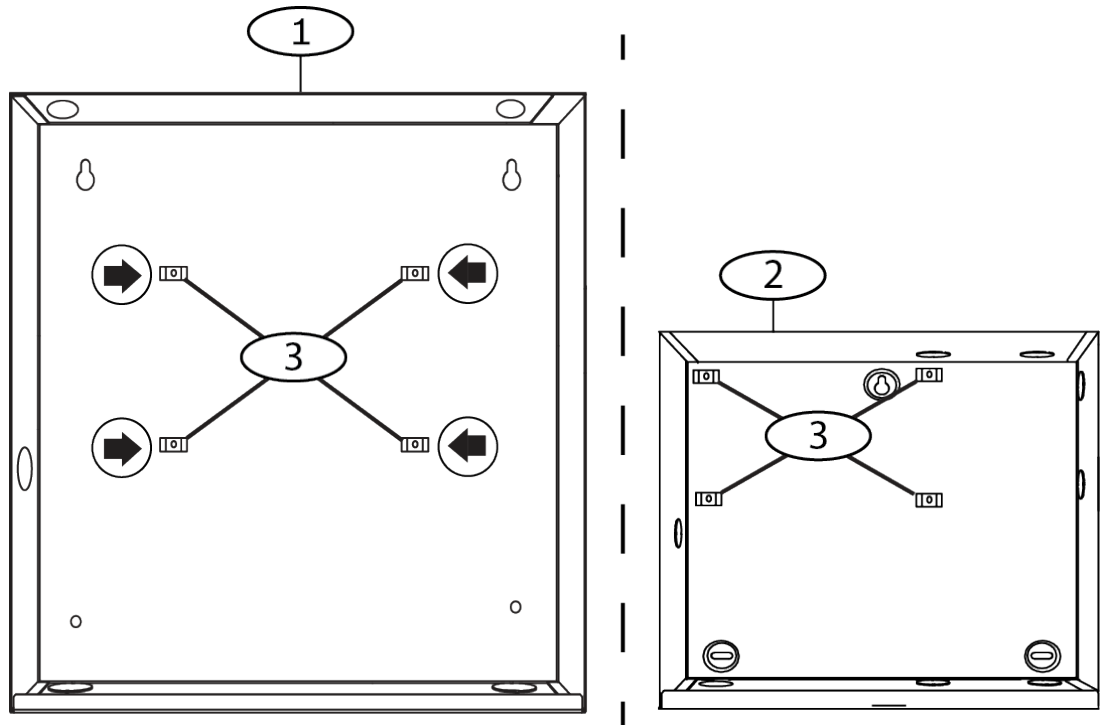

Callout — Description

- | |
|---|
| 1 — B10 Medium Control Panel Enclosure |
| 2 — B11 Small Control Panel Enclosure |
| 3 — Mounting clip locations for the control panel |

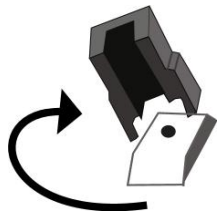
2. Snap the four plastic standoffs onto the four enclosure support posts. If you install a B12, attach the standoffs to the plate support posts. Do not attach the standoff screws.

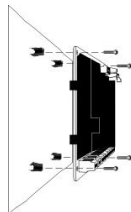

3. Position the control panel on top of the standoffs.
4. Align the holes in the corners of the control panel with the openings at the top of each standoff.
5. Attach and tighten the control panel to the standoffs with the supplied screws.



6. If you install a B12, rest the hook tabs on the mounting plate hooks within the enclosure. Secure the lock-down tab to the plate mounting hole with the screw provided.

5.2.1 Earth ground

To help prevent damage from electrostatic discharges or other transient electrical surges, connect the system to earth ground before making other connections. The earth ground icon identifies the earth ground terminal. Recommended earth ground references are a grounding rod or a cold water pipe. Make the connection using 14 AWG (1.8 mm) to 16 AWG (1.5 mm) wire.

5.2.2 OUTPUT A jumper

OUTPUT A is a form C relay.

- ▶ Choose one of the following uses before you install and configure OUTPUT A:
- +12 VDC (AUX power)
- COM terminal (parallel to all COM terminals)
- Dry contact (no voltage, not common)

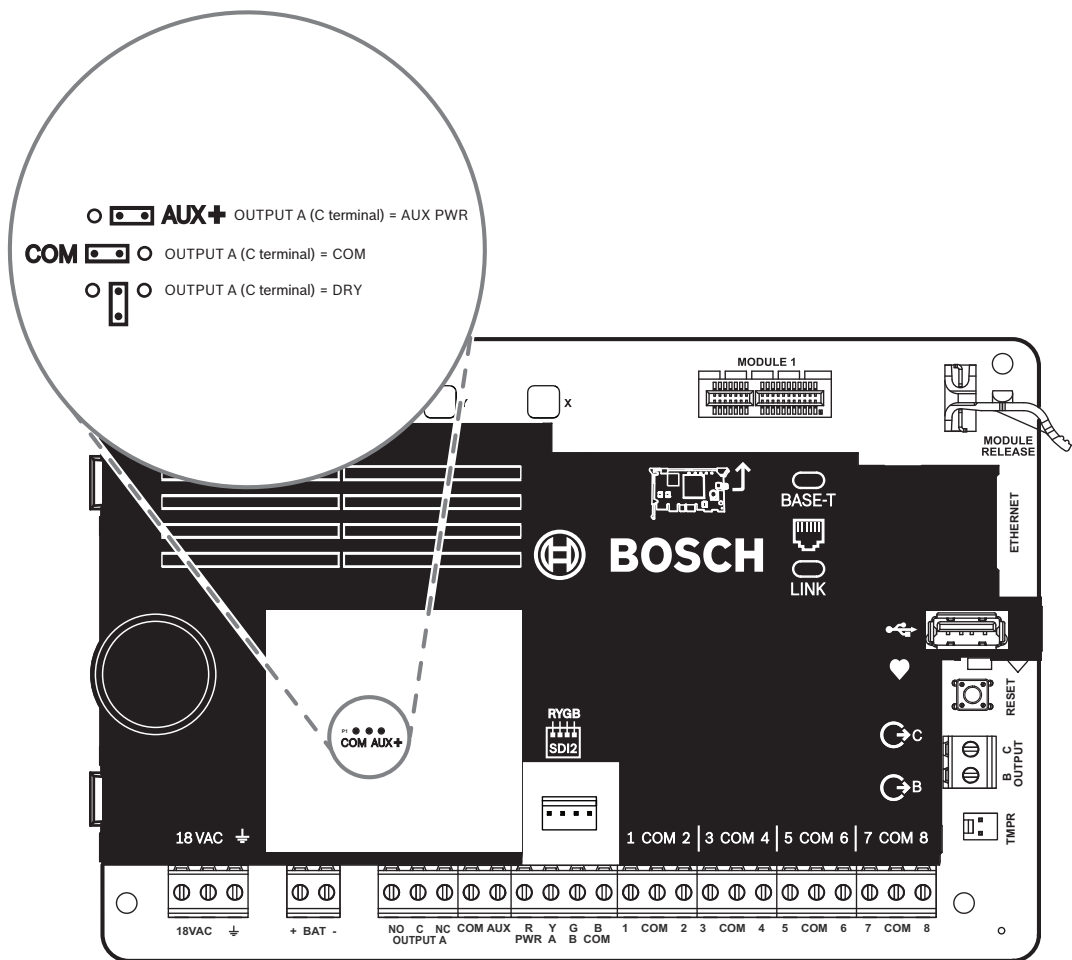

The control panel ships with the jumper in the default position, AUX power. (OUTPUT A, ‘C’ terminal providing AUX PWR).

- ▶ To reconfigure the ‘C’ terminal as a COM terminal (parallel to all COM terminals), remove the door covering the jumper pins, and move the jumper to the left two pins.
- ✓ The OUTPUT A LED lights when OUTPUT A is active.

5.3 Control panel to module wiring overview

You can use interconnect or terminal wiring to connect devices to the control panel.

Using terminal wiring in parallel



Notice!

Wire size

For terminal wiring, use 18 AWG to 22 AWG (1.0 mm to 0.6 mm) wire.

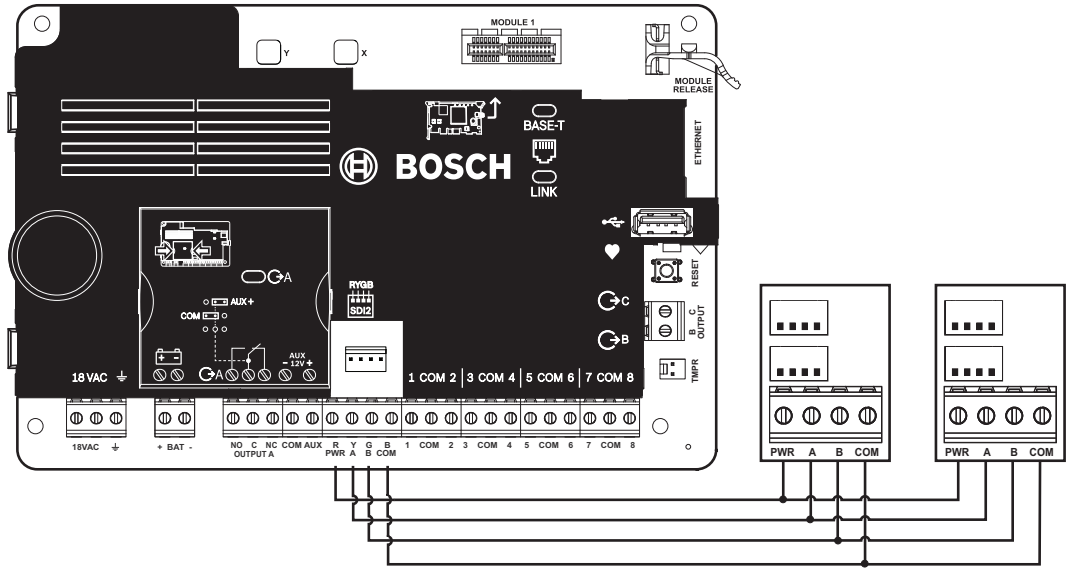

Using interconnect wiring



Notice!

More information

For more information on interconnect wiring, refer to SD12 interconnect wiring.

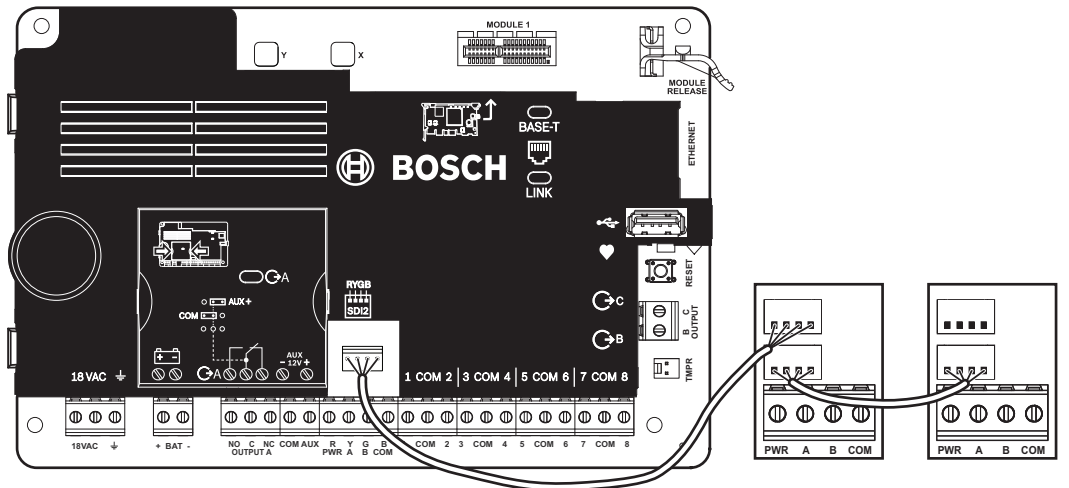

6 Power supply

This section provides information on installing and maintaining primary power, batteries, and auxiliary power.

6.1 Primary (AC) power 18VAC

The control panel uses an 18 VAC, 22 VA internally fused transformer for its primary power source. The control panel draws 125 mA when idle and 155 mA when in the alarm state. The auxiliary power available for powered devices is 800 mA.

Surge protection

Transient suppressors and spark gaps protect the circuit from power surges. This protection relies on the ground connection at the earth ground terminal marked with the \perp icon. Ensure that you connect the terminal to a proper ground.

Refer to *Earth ground*, page 18.

AC power fail

The system indicates an AC power failure when the following terminals do not have sufficient voltage: VAC: The AC Fail Time parameter sets the amount of time without AC power before the control panel reports the failure. It also sets the amount of time after the power returns before the control panel reports restored power.

Self diagnostics at power up and reset

The system performs a series of self-diagnostic tests of hardware, software, and programming at power up and at reset. The self-diagnostics tests complete in approximately 10 to 30 seconds.

If the control panel fails any test, a System Trouble message appears on the keypads.

6.2 Secondary (DC) power + BAT -

A 12 V sealed lead-acid rechargeable battery (such as the D126/D1218) supplies secondary power to maintain system operation during interruptions of primary (AC) power.



Notice!

Use sealed lead acid batteries only

The charging circuit is calibrated for lead-acid batteries. Do not use gel-cell or NiCad batteries.

Extra batteries

To increase battery back-up time, connect a second 12 V battery in parallel to the first battery. Use a D122/D122L Dual Battery Harness to ensure proper and safe connection.

D1218 Battery

The D1218 is a 12 V, 18 Ah battery for use in applications requiring extended battery standby time. The control panel does not support more than 18 Ah.

6.2.1 Install the battery

1. Put the battery upright in the base of the enclosure.
2. Locate the red and black leads supplied in the hardware pack.
3. Connect the black battery lead to BAT- .
4. Connect the other end to the negative (-) side of the battery.
5. Connect the red battery lead to BAT+.
6. Connect the other end to the positive (+) side of the battery.



Warning!
High current arcs are possible

The positive (red) battery lead and the terminal labeled BAT+ can create high current arcs if shorted to other terminals or the enclosure. Use caution when you touch the positive lead and the terminal labeled BAT+. Always disconnect the positive (red) lead from the battery before you remove it from the terminal labeled BAT+.



Caution!
Battery terminals and wire are not power limited

Maintain a 0.250 in (6.4 mm) space between the battery terminals, battery wiring, and all other wiring. Battery wiring cannot share the same conduit, conduit fittings, or conduit knockouts with other wiring.

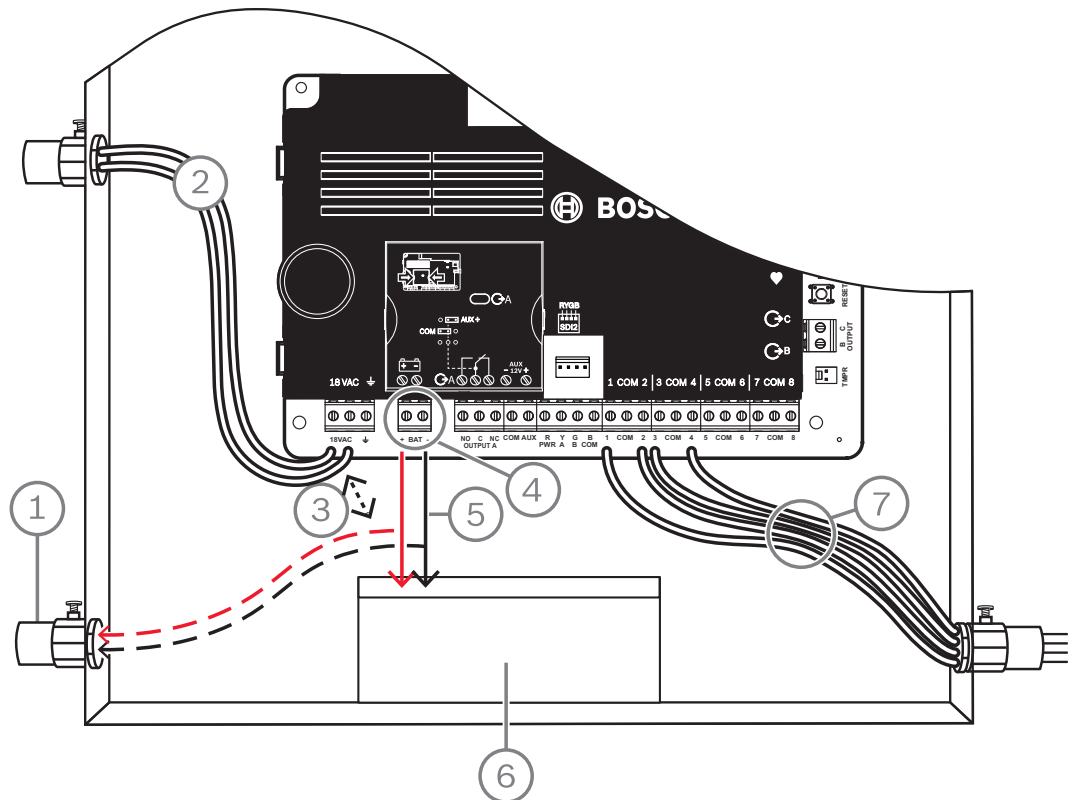

Figure 6.1: Non-power-limited wiring (B5512 shown)

Callout — Description
1 — Conduit required for use with external batteries
2 — To UL listed class 2 transformer 18 VAC 22 VA 60 Hz
3 — 0.25 in (6.4 mm) minimum
4 — Battery terminals. BAT- is non-power limited
5 — Battery wires
6 — 12 V sealed lead-acid rechargeable battery (D126/D1218)
7 — Sensor loop wires

Charging the battery

1. Connect the battery
2. Connect the transformer.
3. Allow the control panel to charge the battery while you complete the installation.

6.2.2

Battery maintenance

Use 12 VDC sealed lead-acid rechargeable battery (7 Ah or 18 Ah). The control panel supports up to 18 Ah of battery. If you use two batteries, they must have the same capacity, and you use a D22/D122L to connect them.

Replace the batteries every 3 to 5 years. If you install two batteries, replace them both at the same time.

Record the date of installation directly on the battery.



Caution!

Heavy discharges possible

The system can have heavy discharges if you exceed the maximum output ratings or install the transformer in an outlet that is routinely switched off. Routine heavy discharges can lead to premature battery failure.

6.2.3

Battery supervision

The battery charging float level occurs at 13.65 VDC. If the battery voltage drops below 12.1 VDC, the control panel sends a LOW BATTERY report and shows keypad messages, if programmed to do so.

The control panel (if programmed for power supervision) sends a Battery Low report in the Conettix Modem4 format. It sends a Low System Battery (302) report in the Conettix ANSI-SIA Contact ID format.

When battery voltage returns to 13.4 V, the keypads stop showing the low battery messages. If the control panel is programmed for power supervision, it sends a BATTERY RESTORAL report in the Conettix Modem4 format or a Control Panel Battery Restored to Normal (302) report in the Conettix ANSI-SIA Contact ID format.

If programmed for power supervision, the control panel adds a missing battery event to the event log. If programmed for battery fault reports, the control panel sends a Battery Missing/Dead report in the Conettix Modem4 format, or Control Panel Battery Missing (311) report in the Conettix ANSI-SIA Contact ID format.

6.2.4

Battery discharge and recharge schedule

Discharge cycle

- 13.65 VDC - Charging float level.
- 12.1 VDC - Low Battery Report, if programmed.
- 10.2 VDC - Minimum operational voltage.

Recharge cycle

- AC ON - Battery charging begins and AC Restoral Reports sent.
- 13.4 V - Battery Restoral Report sent. Battery float charged.

6.3

B520 aux power supply

The optional B520 provides up to 2 A of 12 VDC standby power for Fire and Burglar applications. For Burglar applications, an additional 2 A of alarm power is available, allowing 2 A of standby current and up to 4 A of alarm current.

The control panels support the following number of B520 modules:

- B6512. 4

- B5512. 4
- B4512. 2
- B3512. 2

The power supply draws approximately 15 mA (+/- 1 mA) from the control panel.

For additional information on supported peripherals, refer to the technical documentation of these peripherals.

When using multiple NACs, the power for each D192G to support notification appliances must have its own power limited and isolated power from a UL864 listed supply, such that one NAC does not prevent another NAC from providing its alarm notification operation.

6.3.1 SDI2 address settings



Notice!

The module reads the address switch setting only during module power up. If you change the setting after you apply power to the module, you must cycle the power to the module in order for the new setting to take effect.

If multiple B520 modules reside on the same system, each B520 module must have a unique address.

6.3.2 Supervision

The control panel supervises any B520 on the SDI2 bus.

With any failure to receive an expected response from a B520, all keypads show a system fault. The control panel sends a module trouble report to the central station (if configured for module trouble reports).

6.3.3 Auxiliary power supply trouble conditions

Each auxiliary power supply module on the SDI2 bus monitors several conditions including AC status, battery status, over current status, and a tamper input. Each of these conditions produces a unique system trouble condition at all keypads. The control panel sends a module trouble report to the central station (if configured for module trouble reports).

6.3.4 Installation and control panel wiring (B520)

Calculate power consumption

Make sure that there is enough power for the module and the other powered devices that you want to connect to the system.

Refer to *On-board outputs, page 49*.



Caution!

Remove all power (AC and battery) before making any connections. Failure to do so might result in personal injury and/or equipment damage.

Installing the module

1. Set the module address.
2. Insert the plastic mounting clips onto the standoff locations inside the enclosure or on a mounting skirt, when required.
3. Mount the module onto the plastic mounting clips.
4. Tighten the supplied mounting screws.

Wiring to earth ground

- ▶ To help prevent damage from electrostatic charges or other transient electrical surges, connect the system to earth ground before making other connections.

**Notice!****Earth ground reference**

Do not use telephone or electrical ground for the earth ground connection. Use 14 AWG (1.8 mm) to 16 AWG (1.5 mm) wire when making the connection

Use a grounding rod or a cold water pipe.

Run wire as close as possible to grounding device.

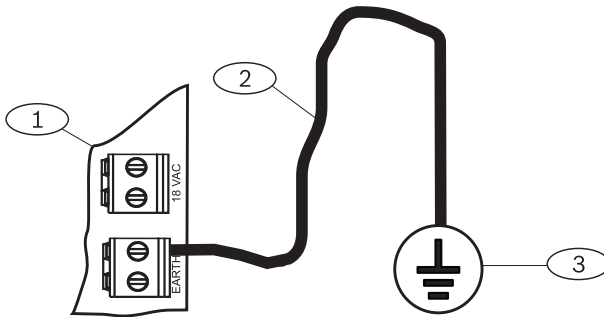
**Callout — Description**

1 — B520 Auxiliary Power Supply Module

2 — 14 AWG - 16 AWG (1.8 mm - 1.5 mm) wire

3 — Ground device (grounding rod or cold water pipe)

Wiring to the control panel**Notice!****Terminal wiring**

Use the terminal strip labeled with PWR, A, B, and COM for SDI2 IN to wire to corresponding control panel SDI2 terminals. Do not use interconnect wiring.

Use 12 AWG to 22 AWG (2.0 mm to 0.6 mm) wire.

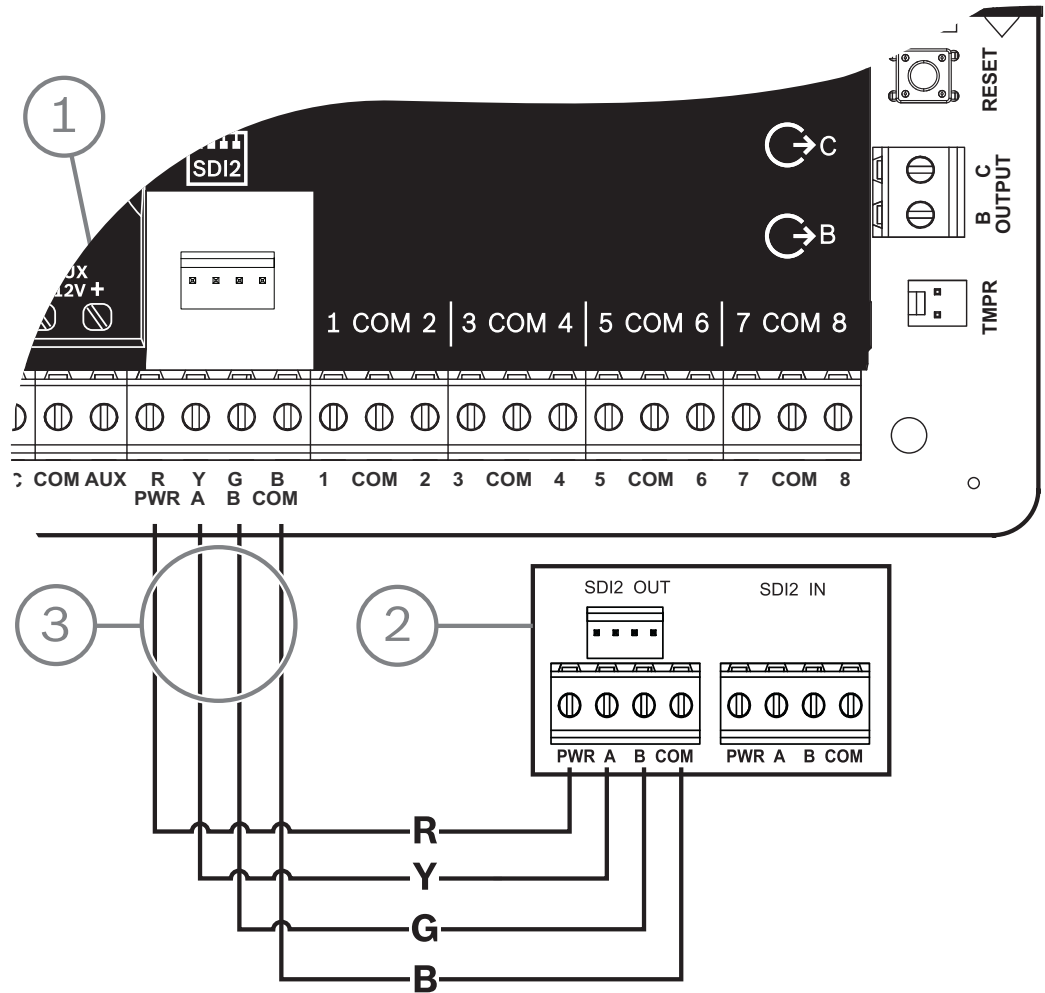

Callout — Description
1 — Control panel
2 — B520 Auxiliary Power Supply Module
3 — Terminal strip wiring

6.3.5 Powered device and battery wiring

When you wire the output of a B520 to a SDI2 module, the B520 provides power to the module while passing through data between the control panel and the module.

Wiring SDI2 modules

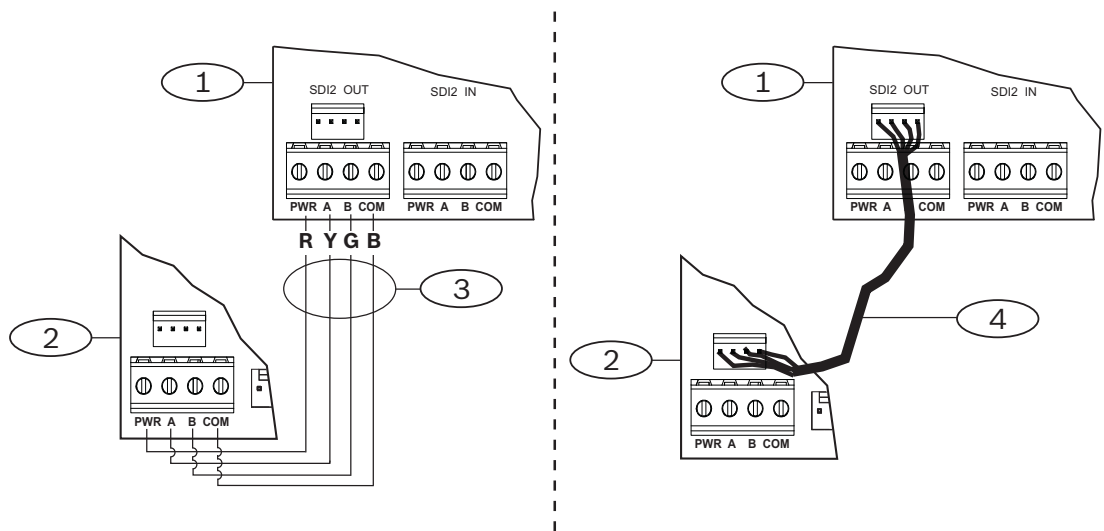

Callout — Description
1 — B520 Auxiliary Power Supply Module
2 — Powered device (SDI2 module)
3 — Terminal strip wiring
4 — Interconnect wiring (P/N: F01U079745)

- Do one of the following:
 Use terminal wiring to connect the SDI2 OUT terminal strip labeled with PWR, A, B, and COM on the B520 to the terminals labeled PWR, A, B, and COM on the first module.
 Connect an interconnect wiring cable (included) to the SDI2 OUT interconnect connector on the B520 to the interconnect connector on the first module.
- Connect additional modules in series with the first module.

Wiring to batteries



Notice!

Battery wiring requirements

You must wire BATT 1. You must wire BATT 2 if you configure the B520 for two batteries. When you use BATT 2, both batteries must have the same rating. Maximum standby power cannot exceed 36 Ah.

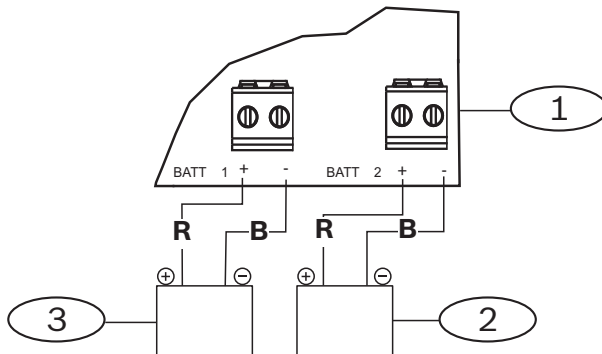

Callout — Description

1 — B520 Auxiliary Power Supply Module
2 — Battery 2 (BATT 2) - (12 V nominal lead acid)
3 — Battery 1 (BATT 1) - (12 V nominal lead acid)

7 Telephone communications

The control panel supports telephone (PSTN) communications with the plug-in telephone communicator (B430).

7.1 B430 Plug-in Communicator, Telephone

The B430 provides communication over PSTN. The module provides a single telephone interface RJ-45 connector for connecting the phone line. The module plugs directly into the control panel with no additional connections required.

The control panel supports one plug-in module plugged directly into the control panel board. The module plugs into a connector and is held in place with a plug-in module retention clip. The module handle and support on top of the module hold the unit during installation. For additional information on supported peripherals, refer to the technical documentation of these peripherals.

When using multiple NACs, the power for each D192G to support notification appliances must have its own power limited and isolated power from a UL864 listed supply, such that one NAC does not prevent another NAC from providing its alarm notification operation.

Notification

The B430 module by Bosch Security Systems, Inc. is registered with the Federal Communication Commission (FCC) under Part 68, for connection to the public telephone system using an RJ31X or RJ38X phone line connection jack installed by the local telephone company.

Do not connect registered equipment to party lines or coin-operated telephones. Notify the local telephone company and provide the following information before connecting the control panel to the telephone network:

- The particular line to which you connect the module
- Make (Bosch Security Systems, Inc.), model (B6512/B5512/B4512/B3512), and serial number of the control panel
- FCC registration number: ESVAL00BB430
- Ringer eq: 0.0B

7.1.1 Supervision

The control panel supervises the phone line. You can configure the supervision time using RPS or the Installer Services Portal programming tool (available in Europe, Middle East, Africa, and China).

7.1.2 Installation and module wiring (B430)

Calculate power consumption

Make sure that there is enough power for the module and the other powered devices that you want to connect to the system.

Refer to *On-board outputs, page 49*.



Caution!

Remove all power (AC and battery) before making any connections. Failure to do so might result in personal injury and/or equipment damage.

Installing the module

1. Align the module with the on-board plug-in connector on the control panel.
2. The retention clip has a locking device to help hold the card in position. Pull the locking device back.

3. Align the PCB metal contacts with the on-board connector.
4. Push the module into place. The retention clip snaps closed to hold the module in position.

Wiring to the phone line

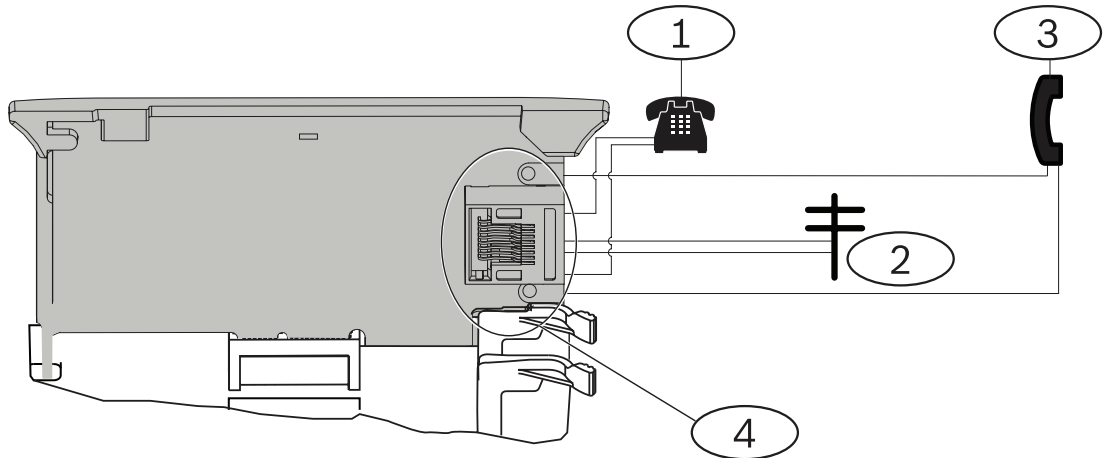

Callout — Description
1 — Premises telephone
2 — Incoming Telco line
3 — Installer telephone test set
4 — RJ-45 phone connector

7.1.3

Diagnostic LEDs

The module uses a green LED to show:

- Whether the module is on or off hook.
- When the line rings (incoming phone call).

Flash pattern	Function
OFF	Standby
ON	Line seized
Flash	Ringing detect (incoming phone call)

Tab. 7.1: PTSN diagnostic LED patterns

7.2

Phone jack location

To prevent jamming of signals, wire the RJ31X or RJ38X jack before the premises telephone system to support line seizure. Install the jack on the street side of the telephone switch, wired ahead of any PBX equipment. Line seizure temporarily interrupts normal telephone use while the control panel sends data. After installation, make sure that the control panel:

- Seizes the line
- Gets a dial tone
- Reports correctly to the receiver
- Releases the telephone line to the in-house telephone system

RJ31X wiring

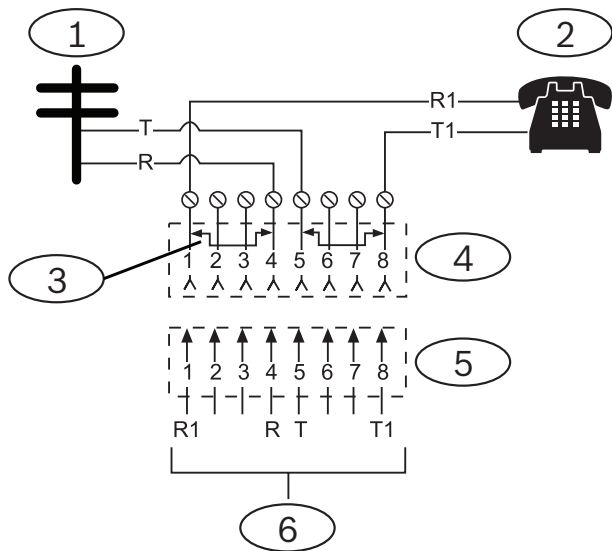

Callout — Description
1 — Outside Telco
2 — Premises telephone
3 — Bar short removed on Telco connector block insertion – positions 1 and 4 and 5 and 8
4 — RJ31X jack
5 — Telco connector block
6 — To control panel

7.3 Telephone line monitor

The B430 module has a built-in telephone line monitor that tests the telephone line for voltage and current. The normal voltage on a telephone line is approximately 48 VDC (24 VDC for some telephone systems).

If the module senses trouble, it starts a programmable telephone line trouble timer, which continues to run as long as the monitor detects trouble. It resets to zero when the control panel senses a normal line. If the timer reaches the delay time in the Phone Supervision program item, it begins a telephone line trouble response. Programming determines what the response is. For programming information, refer to Phone Parameters in RPS Help or in the Installer Services Portal programming tool (available in Europe, Middle East, Africa, and China) Help.



Notice!
Bad line might test OK

The telephone line monitor uses voltage levels to test the status of the telephone line. In some instances, a given telephone line might be out of service without affecting the voltage on the line. The telephone line monitor cannot recognize this trouble condition.

7.4 Called party disconnect

Telephone companies provide “called party disconnect” to allow the called party to terminate a call. The called party must go on hook (hang up) for a fixed interval before a dial tone is available for a new call. This interval varies with telephone company equipment. Control panel

firmware allows for “called party disconnect” by adding a 35-seconds “on hook” interval to the dial tone detect function. If the control panel does not detect a dial tone in 7 seconds, it puts the telephone line on hook for 35 seconds to activate “called party disconnect,” goes off hook, and begins a seven-seconds dial tone detect. If no dial tone is detected, the control panel dials the number anyway. Each time the control panel dials the number, the control panel records this as an attempt.

7.5 Communication failure

A control panel can have one primary and up to three backup destination devices configured per route group.

The first ten attempts to send a report

If the first two attempts to send a report to the central station receiver over the primary destination device fail, the control panel switches to the backup destination device, then the second backup destination device, then the third backup destination device, depending on how many are configured and tries to reach each backup destination device two times. If all backup destination devices fail, the control panel tries the primary destination device again. During these attempts, no events are recorded.

After ten unsuccessful attempts to send a report

After ten unsuccessful attempts to send a report to the central station receiver, the following happens:

- Communication failure
 - The route group has a communication failure and is unable to send a report.
 - All queued reports will be cleared and marked as failed.
 - The control panel generates a COMM FAIL event that is sent with the other route groups and is shown on the keypads. A trouble sounder can be programmed to sound at the keypads.
- Communication trouble
 - The control panel sends a heartbeat at least once an hour to the failed destination devices, from primary destination device to all backup destination devices.
 - If the failed destination devices do not send back an acknowledgment within the configured acknowledgment wait time and retry count, the failed destination devices have a communication trouble and are unable to communicate.
 - The control panel generates a COMM TROUBLE event that is sent with the other route groups and is shown on the keypads. A trouble sounder can be programmed to sound at the keypads.
- Communication restored
 - After a COMM FAIL report is sent successfully, the communication is restored.
 - A COMM RSTL report is sent to the central station receiver.

8 IP communications

IP communication

The control panel can use IP to communicate with a Conettix D6600 or a Conettix D6100IPv6 communications receiver/gateway. Use one of the following for IP:

- The on-board Ethernet connection
- Ethernet Communication Module: B426
- Plug-in cellular communicator: B442/B443/B444-A/B444-V

Conettix IP communication provides a secure path that includes anti-replay/anti-substitution features, and enhanced security with up to AES 256-bit encryption (using Cipher Block Chaining (CBC)).

The control panel supports Domain Name System (DNS) for both remote programming and central station communication. DNS provides ease of use, eliminating the need to use static IP addresses as your reporting destination, and accommodates a simple solution for central station disaster recovery. The control panel supports both IPv6 and IPv4 networks.



Notice!

For premises equipment used in the communication path, such as routers, use only UL listed equipment.

8.1 On-board Ethernet connection

The built-in Ethernet port on the control panels give a network connection so that you do not need to install additional modules. The port supports both 10 Base-T (10 Mb) and 100 Base-TX (100 Mb) standards. The port supports full duplex, half duplex, and HP AUTO_MDIX communication, using a standard Ethernet cable. You can use this connection for:

- Central station reporting
- Automation
- Programming

8.1.1 Supervision

The control panel supervises its on-board Ethernet connection in these cases:

- The on-board Ethernet connection is used in any of the four route groups as part of either the primary destination device or one of the three backup destination devices.
- The on-board Ethernet connection is used as an automation device.

If the on-board Ethernet connection does not respond to control panel supervision polls, a system fault message shows on the keypads.

8.1.2 Local programming

Use the on-board Ethernet connection to locally connect with RPS or the Installer Services Portal programming tool (available in Europe, Middle East, Africa, and China). This connection method requires a direct IP connection from the RPS or Installer Services Portal programming tool computer to the on-board Ethernet port.

Connecting the control panel to RPS or the Installer Services Portal programming tool using IP Direct:

1. If the control panel does not use the Ethernet for IP communication, perform Steps 2 and 3. If the control panel does use the Ethernet for IP communication, power down the control panel and remove the Ethernet cable that connects the control panel to the network.

2. Connect the control panel to the RPS or Installer Services Portal programming tool computer using the Ethernet ports and a standard Ethernet cable, and apply power to the control panel, if applicable. Within 2 minutes, the RPS or Installer Services Portal programming tool computer assigns an IP address using AutoIP.
3. In RPS or the Installer Services Portal programming tool, open the control panel account and click the Connect button. From the Connect Via drop-down list select IP Direct. Click Connect. Once connected, perform the necessary tasks, and disconnect when finished.
4. Reconnect the cable used for IP communication, if applicable.

For more information on using AutoIP, refer to *AutoIP, page 146*.

8.1.3 On-board Ethernet diagnostic LEDs

The control panel includes the following on-board LEDs to assist with troubleshooting the on-board Ethernet connection.

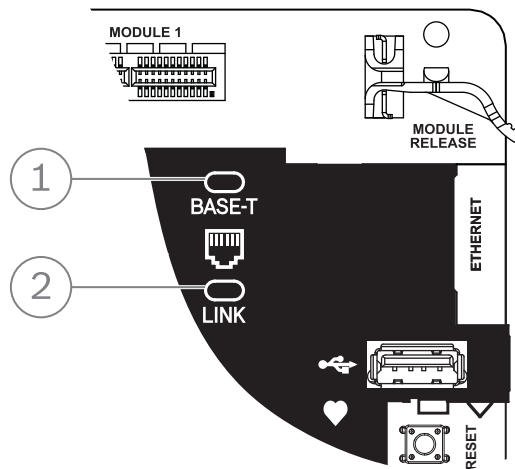





Figure 8.1: On-board Ethernet and LEDs (B5512 shown)



Callout — Description
1 — 100BASE-T LED (green)
2 — LINK LED (yellow)

► Refer to the following tables for information on the 100BASE-T and LINK LEDs.

Flash pattern	Function
 On Steady	Communicating at 100 Mb.
 Off	Communicating at 10 Mb.

Tab. 8.2: 100BASE-T LED descriptions

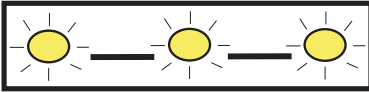
Flash pattern	Function
 On Steady	Plugged into an Ethernet network.

Flash pattern	Function
 Flashing	Communication in progress.
 Off	Unplugged from an Ethernet network, or the Ethernet network is not available.

Tab. 8.3: LINK LED descriptions

8.2 Conettix Plug-in cellular modules

Plug-in cellular modules provide communication between the control panel and central monitoring stations, RPS or the Installer Services Portal programming tool (available in Europe, Middle East, Africa, and China) using a cellular network. The module sends and receives SMS messages for personal notification or system configuration.

The control panel supports one plug-in cellular module.

Connect a module using the plug-in module connector or using a B450 (refer *B450 Conettix plug-in communicator interface, page 38*).

For additional information on supported peripherals, refer to the technical documentation of these peripherals.

When using multiple NACs, the power for each D192G to support notification appliances must have its own power limited and isolated power from a UL864 listed supply, such that one NAC does not prevent another NAC from providing its alarm notification operation.

8.3 B426 Ethernet Communication Module

The B426 is a four-wire powered SDI2 device with Ethernet port for IP connectivity.

Refer to the module's installation documentation for more information.

The control panel supports one module.

The module connects to the SDI2 bus on the control panel using the SDI2 terminals, or using the SDI2 interconnect wiring connector.

For additional information on supported peripherals, refer to the technical documentation of these peripherals.

When using multiple NACs, the power for each D192G to support notification appliances must have its own power limited and isolated power from a UL864 listed supply, such that one NAC does not prevent another NAC from providing its alarm notification operation.

8.3.1 Address and emulation settings



Notice!

The module reads the address switch setting only during module power up. If you change the setting after you apply power to the module, you must cycle the power to the module in order for the new setting to take effect.

Set the address switch to 1.

8.3.2 Supervision

The control panel supervises in two ways:

- Module supervision. The control panel supervises the module through polling. If the module does not respond to the control panel polling, the control panel declares the device missing.

- Communication supervision. The control panel supervises the communication path by polling the central station receiver. If the poll is missed from either side, a communication fault is declared both at the control panel and the central station receiver.

8.3.3

B426 module faults

With a B426 installed, several services become available to the control panel. Any break in the Ethernet connection to a supervised B426 results in a system fault at the keypads indicating Open Cable trouble.

If a Domain Name Server (DNS) is available on the network, a failure to resolve an individual Network Address hostname results in a system fault at the keypads indicating DNS ERROR ##. The error number represents the communication module and destination combination that failed. For details on communication module/destination combinations, refer to RPS Help or to the Installer Services Portal programming tool (available in Europe, Middle East, Africa, and China) Help. The keypad shows a failure to resolve the domain name used for RPS Network Address.

If a B426 fails all communication with the DNS, a system fault error shows on all keypads and the control panel sends a trouble event to the central stations, if enabled.

8.3.4

Installation and control panel wiring (B426)

Calculate power consumption

Make sure that there is enough power for the module and the other powered devices that you want to connect to the system.

Refer to *On-board outputs, page 49*.



Caution!

Remove all power (AC and battery) before making any connections. Failure to do so might result in personal injury and/or equipment damage.



Notice!

Requirement

Install the module in the enclosure with the control panel or in an adjacent enclosure that is no more than 1000 ft (305 m) from the control panel. Use 18 AWG to 22 AWG (1.0 mm to 0.6 mm) wire.

Installing the module

1. Set the module address.
2. Hold the module mounting brackets onto the inside of the enclosure. Match the bracket holes to a 3-hole mounting pattern on the enclosure
3. Use the supplied mounting screws to secure the module.

Wiring the module to the control panel

Use either the terminal strip labeled with PWR, A, B, and COM on the module to wire to the SDI2 terminals labeled on the control panel, or use the interconnect wiring connector and the included interconnect cable.

For terminal wiring, use 18 AWG to 22 AWG (1.0 mm to 0.6 mm) wire.



Notice!

Use either the terminal strip wiring or interconnect wiring to the control panel. Do not use both. When you connect multiple modules, you can combine terminal strip and interconnect wiring connectors in parallel.

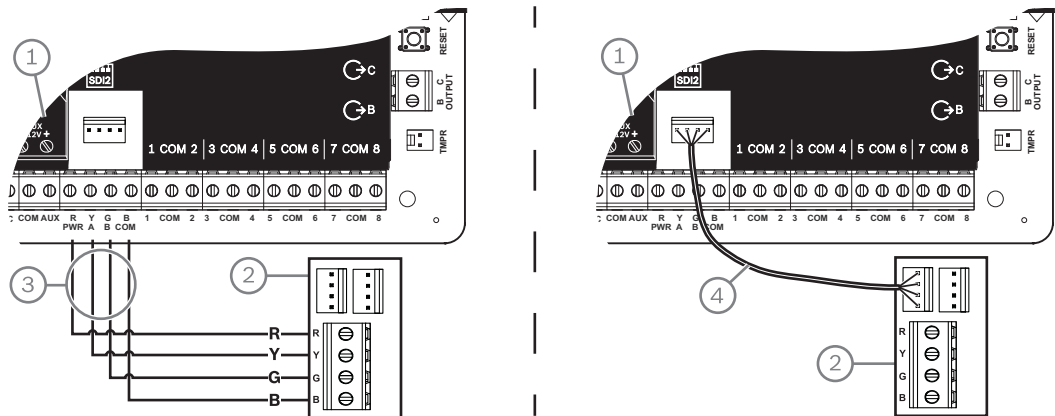

Callout — Description
1 — Control panel
2 — Module
3 — Terminal strip wiring
4 — Interconnect cable (P/N: F01U079745) (included)

Connecting the module to the network

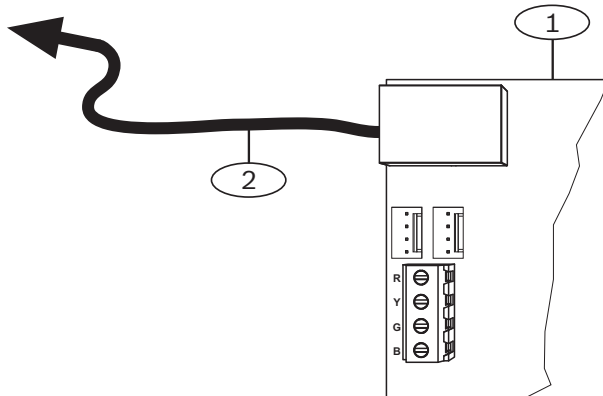

Callout — Description
1 — B426 module
2 — Ethernet cable to network jack





1. Connect an Ethernet cable to the Ethernet port on the module.
2. Connect the Ethernet cable to the RJ-45 network jack.

8.3.5



Diagnostic LEDs

The module has the following on-board LEDs to assist with troubleshooting:











- Heartbeat (system status).
- RX (receive).
- TX (transmit).

Flash pattern	Function
 Flashes once every 1 sec	Normal state. Indicates normal operation state.
 3 quick flashes every 1 sec	Communication error state. Indicates a bus communication error. The module is not receiving commands from the control panel.
 On Steady	Trouble state. Indicates a trouble condition exists.
 Off	LED trouble state. Module is not powered, or some other trouble condition prohibits the module from controlling the heartbeat LED.

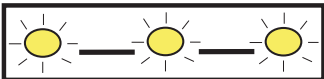
Tab. 8.4: Heartbeat LED descriptions

Flash pattern	Function
 RX (Receive) Flashing	Occurs when the module receives a message over the network connection – UDP, TCP, or DNS.
 TX (Transmit) Flashing	Occurs when the module sends a message over the network connection – UDP, TCP, or DNS.

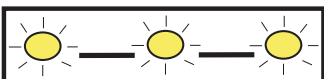
Tab. 8.5: RX and TX LEDs descriptions

LINK (yellow) LED pattern	100Mb (green) LED pattern	Function
 Off	 Off	No Ethernet link
 On Steady	 Off	10Base-T link
 Flashing	 Off	10Base-T activity
 On Steady	 On Steady	100Base-TX link
 Flashing	 On Steady	100Base-TX activity

Tab. 8.6: Ethernet Link LEDs descriptions

8.3.6 Local programming

Use the B426 IP Direct connect feature to locally connect with RPS or the Installer Services Portal programming tool (available in Europe, Middle East, Africa, and China).

Connecting the B426 to RPS or the Installer Services Portal programming tool using IP Direct

1. If the module does not use the Ethernet for IP communication, skip to the next step. If the module does use the Ethernet for IP communication, power down the module and remove the Ethernet cable that connects it to the network.
2. Connect an Ethernet cable to the module.
3. Connect the same Ethernet cable to the computer on which you installed RPS or the Installer Services Portal programming tool.
4. Apply power to the module, if applicable. Within 2 minutes, the RPS or Installer Services Portal programming tool computer assigns an IP address with AutoIP.
5. In RPS or in the Installer Services Portal programming tool, open the control panel account and click Connect.
6. From the Connect Via drop-down list select IP Direct. Click Connect.

Make sure that you reconnect the cable used for IP communication, if applicable.

For more information on using AutoIP, refer to *AutoIP*, page 146.

8.4 B450 Conettix plug-in communicator interface

The B450 holds a plug-in cellular module so that it can connect to the control panel with SDI2 terminal wiring or SDI2 interconnect wiring.

The B450 supports one cellular plug-in module.

For additional information on supported peripherals, refer to the technical documentation of these peripherals.

When using multiple NACs, the power for each D192G to support notification appliances must have its own power limited and isolated power from a UL864 listed supply, such that one NAC does not prevent another NAC from providing its alarm notification operation.

8.4.1 SDI2 address settings



Notice!

The module reads the address switch setting only during module power up. If you change the setting after you apply power to the module, you must cycle the power to the module in order for the new setting to take effect.

The control panel supports one module. Set the address switch to 1.

8.4.2 Supervision

The control panel supervises in two ways:

- Module supervision. The control panel supervises the module through polling. If the module does not respond to the control panel polling, the control panel declares the device missing.
- Communication supervision. The control panel supervises the communication path by polling the central station receiver. If the poll is missed from either side, a communication fault is declared both at the control panel and the central station receiver.

8.4.3 Installation and control panel wiring (B450)

Calculate power consumption

Make sure that there is enough power for the module and the other powered devices that you want to connect to the system.
Refer to *On-board outputs, page 49*.



Caution!

Remove all power (AC and battery) before making any connections. Failure to do so might result in personal injury and/or equipment damage.

Inserting the cellular module

1. Install a SIM card, if required by the cellular module.
2. Push the plug-in cellular module into the B450 until you hear the module “click” into position.

Installing the module

1. Set the module address.
2. Hold the module mounting brackets onto the inside of the enclosure. Match the bracket holes to a 3-hole mounting pattern on the enclosure
3. Use the supplied mounting screws to secure the module.

Wiring the antenna

1. Secure the antenna cable to the outside of the enclosure.
2. Route the antenna cable through a wire knockout in the top of the enclosure.
3. Connect the antenna cable to the cellular module.

Wiring to the control panel

Use either the terminal strip labeled with PWR, A, B, and COM on the module to wire to the SDI2 terminals labeled on the control panel, or use the interconnect wiring connector and the included interconnect cable.

For terminal wiring, use 18 AWG to 22 AWG (1.0 mm to 0.6 mm) wire.



Notice!

Use either the terminal strip wiring or interconnect wiring to the control panel. Do not use both. When you connect multiple modules, you can combine terminal strip and interconnect wiring connectors in parallel.

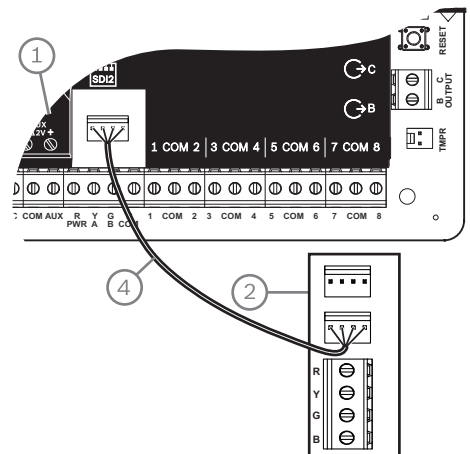
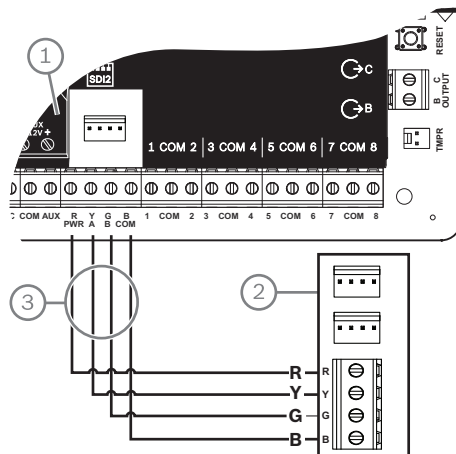

8.4.4



Diagnostic LEDs

The module includes the following on-board LEDs to assist with troubleshooting:

- Heartbeat (system status)

- RX (receive)
- TX (transmit)

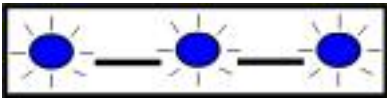
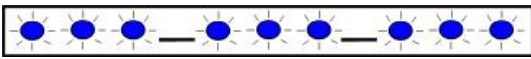
The plug-in module also includes LEDs for troubleshooting and status.

Flash pattern	Indication
 <p>Flashes once every 1 second</p>	Normal state.
 <p>3 quick flashes every 1 second</p>	Communication error state. Error on the bus between the module and the control panel.
 <p>On Steady</p>	Trouble state. Examine the other LEDs to determine the trouble condition.
 <p>Off</p>	LED trouble state. The module does not have power, or the module failed. Check for proper installation.

Tab. 8.7: Heartbeat LED descriptions

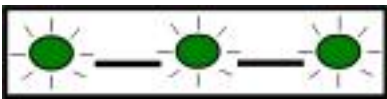
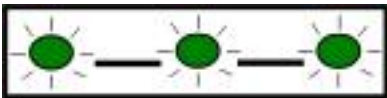
Flash pattern	Function
<p>RX (Receive)</p>  <p>Flashing</p>	Occurs every time a packet is received on-air.
<p>TX (Transmit)</p>  <p>Flashing</p>	Occurs every time a packet is transmitted on-air.

Tab. 8.8: RX and TX LED descriptions

Refer to the module’s Installation and Operation Guide for more information on the LEDs and troubleshooting.

8.5 Compatible receivers for IP communication

Conettix Modem4 format

When you configure the control panel to send reports in Conettix Modem4 format, the Conettix central station receiver/gateway and the D6200CD Receiver programming software might require an update.

- ▶ Update your device according to this table:

Receiver/Gateway	CPU version	D6200CD version
D6600 Central station receiver, 32-line (with D6641 Telephone line card installed only)	01.10.00	2.10
D6100IPV6-LT Central station receiver, 2-line, IP	01.10.00	2.10

Conettix ANSI-SIA Contact ID format

When you configure the control panel to send reports in Conettix ANSI-SIA Contact ID format, the Conettix central station receiver/gateway and the D6200CD Receiver programming software might require an update.

- ▶ Update your device according to this table:

Receiver/Gateway	CPU version	D6200 version
D6600 Central station receiver, 32-line (with D6641 Telephone line card installed only)	01.03.02	1.35
D6100IPV6-LT Central station receiver, 2-line, IP	61.10.00	2.10

ULC-S304 and ULC-S559 compliant report format**Notice!**

ULC-S304 and ULC-S559 compliant report format

For ULC-S304 and ULC-S559 compliant report formats, the Conettix central station receiver/gateway and the D6200CD Receiver programming software need to use the version in the table.

- ▶ Update your device according to this table:

Receiver/Gateway	CPU version	D6200 version
D6600 Central station receiver, 32-line (with D6641 Telephone line card installed only)	01.11.00	2.20
D6100IPV6-LT Central station receiver, 2-line, IP	61.11.00	2.20

ANSI-SIA DC-09 format

Use of the ANSI-SIA DC-09 format requires a central station receiver that supports this IP communicator format. Bosch Conettix central station receivers do not currently support this format.

**Notice!**

UL and ULC LISTED applications

ANSI-SIA DC-09 format is not available for UL and ULC LISTED applications.

9 Keypads, keyswitches, keyfobs and transmitters

To turn areas on and off, users and the system can use one or a combination of the following:

- *Keypads, page 42*
- *Keyswitches, page 46*
- *RADION keyfobs and Inovonics pendant transmitters, page 48*

The control panels provide up to the following number of areas:

- B6512. 6
- B5512. 4
- B4512. 2
- B3512. 1

Refer to Areas and accounts for a description of areas.

9.1 Keypads

Keypads are four-wire powered devices used to operate the system and show system status.

The control panels provide up to the following number of keypads:

- B6512. 12
- B5512. 8
- B4512. 8
- B3512. 4

SDI2 keypads connect to the SDI2 bus on the control panels using terminals PWR, A, B, and COM.

You can connect more than one keypad to the control panel by wiring them in series.

The control panel sends a trouble report if it loses communication with a keypad. A message shows on all keypads.

For additional information on supported peripherals, refer to the technical documentation of these peripherals.

When using multiple NACs, the power for each D192G to support notification appliances must have its own power limited and isolated power from a UL864 listed supply, such that one NAC does not prevent another NAC from providing its alarm notification operation.

9.1.1 Keypads overview

B940W

The keypad has a graphical interface for controlling the system, and touch screen keys for data or command entry.

B942/B942W

The keypad has a credential reader, a presence sensor, one output, four supervised inputs, a graphical interface for controlling the system, and touch screen keys for data or command entry.

Each sensor loop is assigned a point number. The keypad transmits sensor loop status to the control panel individually. The control panel detects open, short, and normal circuit conditions on the keypad sensor loops.

B930

The keypad features a bright five line display and eight softkeys. It has dedicated function buttons for common commands.

B926F

The keypad is a fully supervised SDI2 device for fire applications. The keypad display and sounder alert to a fire alarm, a fire trouble, or fire supervisory events as they occur. The keypad includes fire status indicators and fire function keys.

B925F

The keypad is a fully supervised SDI2 device for fire and combined fire/burg applications. The keypad display and sounder alert to a fire alarm, a fire trouble, or fire supervisory events as they occur. The keypad includes fire status indicators, burg indicators, and fire and burg function keys.

B921C

The keypad features capacitive keys and four supervised inputs.

Each sensor loop is assigned a point number. The keypad transmits sensor loop status to the control panel individually. The control panel detects open, short, normal, and ground fault circuit conditions on the keypad sensor loops.

Each sensor loop is assigned a point number. The keypad transmits sensor loop status to the control panel individually. The control panel detects open, short, and normal circuit conditions on the keypad sensor loops.

B920

The keypad display shows two lines, 18 characters per line. Each keypad has 10 number keys and seven function keys, and a on-display help.

B915/B915I

The keypads offer the same commands and menu structure as the other SDI2 intrusion keypads, with basic text or icons.

User interface languages

The following table shows the available languages per keypad type.

	B915/B915I	B920	B921C	B930	B940W/ B942/B942W
English	✓	✓	✓	✓	✓
Chinese	✓				✓
Dutch	✓	✓	✓	✓	✓
French	✓	✓	✓	✓	✓
German	✓	✓	✓	✓	✓
Greek	✓				✓
Hungarian	✓	✓	✓	✓	✓
Italian	✓	✓	✓	✓	✓
Polish	✓				✓
Portuguese	✓	✓	✓	✓	✓
Spanish	✓	✓	✓	✓	✓
Swedish	✓	✓	✓	✓	✓

SDI keypads

The control panel supports the following SDI keypads on the SDIx bus (when programmed for SDI in RPS or in the Installer Services Portal programming tool (available in Europe, Middle East, Africa, and China)).

- D1255/D1255B/D1255RB/D1255W. 16-character alphanumeric display for general use.
- D1256RB. Text display keypad with keys designated for local fire alarm control.
- D1257RB. Text display keypad for fire annunciation.

- D1260/D1260B: Easy-to-read, 4-line by 20-character LCD display keypad with eight softkeys. Addressable to SDI addresses 1 through 8.

9.1.2 B921C Two-line Capacitive Keypad with Inputs

9.1.3 Shortcuts and custom functions

SDI2 intrusion keypads have a Shortcuts feature. You can assign commonly used or custom functions to a Shortcuts menu. Use RPS or the Installer Services Portal programming tool (available in Europe, Middle East, Africa, and China) to create and assign shortcuts and custom functions.

Custom functions

Custom functions allow you to combine multiple functions into a single function. Assign custom functions to a keypad Shortcut so that the users can easily run the function from the keypad.

The user must have the appropriate authority level enabled to use the custom function.

For more information, refer to RPS Help or to the Installer Services Portal programming tool (available in Europe, Middle East, Africa, and China) Help.

9.1.4 Address settings

The control panel uses the keypad's address setting for communication and bus supervision. If multiple keypads reside on the same system, each keypad must have a unique address even when on different buses.

B94x/B93x/B92x keypads

B93x and B92x keypads use two hardware address switches. The B94x keypads use two virtual (on-screen) switches that mimic the hardware switches. For single-digit addresses 1 through 9, set the tens switch to 0. The figure shows the keypad switches set to 1:

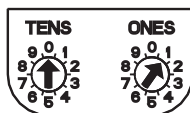

9.1.5 Supervision

The control panel supervises all enabled SDI2 keypads.

If the control panel does not receive an expected response from a keypad, all keypads in the system show a missing keypad error. You can configure the control panel to send a keypad missing report to the central station.

9.1.6 Installation and control panel wiring (keypads)

Calculate power consumption

Make sure that there is enough power for the module and the other powered devices that you want to connect to the system.

Refer to *On-board outputs*, page 49.

Installing a keypad

1. Open the keypad.
2. Set the keypad address using the address switches
3. Use the provided anchors and screws to mount the keypad base on the wall.
4. Pull the necessary wiring through the mounting plate. Refer to *Wire to the control panel*, page 45.
5. Install the keypad on the base.

Wire to the control panel



Notice!

Installation notes

Connect SDI2 keypads to the SDI2 bus by parallel wire run from the control panel to each keypad, wire from keypad to keypad, or a combination of the two. Use a maximum of 7500 ft (2286 m) of 22 AWG (0.65 mm) wire for all devices connected to the SDI2 bus combined.

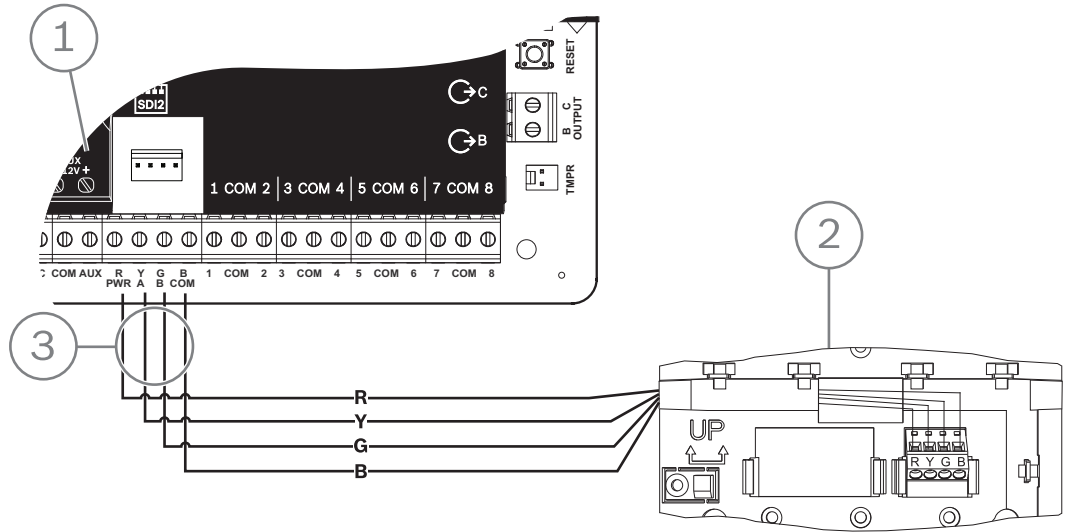

1	Control panel
2	Keypad
3	Terminal strip wiring

Refer to

– *Wire to the control panel, page 45*

9.1.7

Sensor loops overview and wiring (B921C/B942/B942W only)

The keypad detects three states (Open, Supervised, Short) on its sensor loops and sends the conditions to the control panel. Each sensor loop has an assigned point number.

Use twisted-pair wire for the module sensor loops to avoid electromagnetic interference problems. Run wires away from the premises telephone and AC wiring.

To wire detection devices to keypad inputs, connect them to the keypad terminals labeled for COM, and 1, 2, 3, or 4. Wire resistance on each sensor loop must be less than 100 Ω with the detection devices connected. The terminal strip supports 12 to 22 AWG (0.65 to 2 mm) wires.

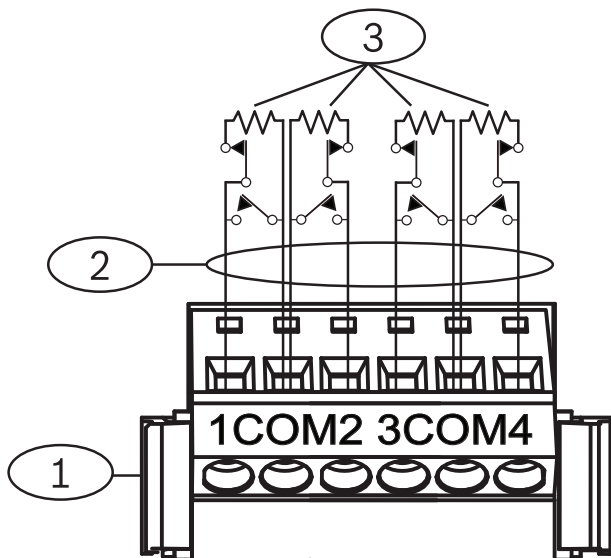

Figure 9.1: Keypad inputs wiring (B921C shown)

Callout — Description
1 — Keypad terminal strip
2 — Sensor loop
3 — 1 kΩ EOL resistor (P/N: F01U026703)

9.1.8 Output wiring (B942/B942W only)

The keypad provides one NO (normally open) output. (It includes NO and C (COMMON) terminals.) When the output is in an active (energized) state, the NO has continuity with the C terminal.

9.1.9 Troubleshooting

Keypads show a Call for Service message when they cannot communicate with the control panel. The most common causes are:

1. The address switch on the keypad is set to an address that is not programmed in the control panel. Change the address switch to the proper address, or program the control panel using RPS, the Installer Services Portal programming tool (available in Europe, Middle East, Africa, and China) or a different keypad.
2. If your keypads are not powered from the control panel, the control panel might have lost power. Confirm the control panel has power.
3. The wiring from the keypad to the control panel is not correct or has failed. Resolve any wiring problems.

9.2 Keyswitches

You can connect a maintained or momentary contact keyswitch to turn an area All On (armed) or Off (disarmed). Connect the keyswitch to an on-board or off-board point's sensor loop. You can program outputs to activate arming status LEDs. Refer to Outputs in RPS Help or in the Installer Services Portal programming tool (available in Europe, Middle East, Africa, and China) Help.

9.2.1

Operation

Maintained contact

For points connected to the keyswitch and programmed for a maintained contact, an open on the sensor loop turns the area All On (armed). The control panel force arms all faulted points, regardless of the entry in the FA Bypass Max program item. Returning the circuit to normal turns the area off.

Momentary contact

For points connected to the keyswitch and programmed for a momentary contact, shorting the arming sensor loop toggles the area's arming state between All On (armed) and Off (disarmed). The control panel force arms all faulted points, regardless of the entry in the FA Bypass Max program item.

Refer to Area Parameters and Point Assignments in RPS Help or in the Installer Services Portal programming tool (available in Europe, Middle East, Africa, and China) Help.

Silence the bell

To silence the bell (stop Alarm Bell output) if the system is On (armed), operate the keyswitch to turn the area off. If the area is disarmed, turn the keyswitch once to start the arming process. Turning the keyswitch a second time stops the arming process and silences the bell.

9.2.2

Installation and control panel wiring (keyswitches)

For maintained switches, connect the EOL resistor for the point at the keyswitch so that the switch opens the circuit when it operates. A short on the circuit produces an alarm if the area is armed and a trouble if it is disarmed.

For momentary keyswitches, connect the EOL resistor at the keyswitch point so that when the keyswitch operates, it shorts the resistor. An open on the circuit causes an alarm if the area is on (armed) and a trouble if it is off (disarmed).

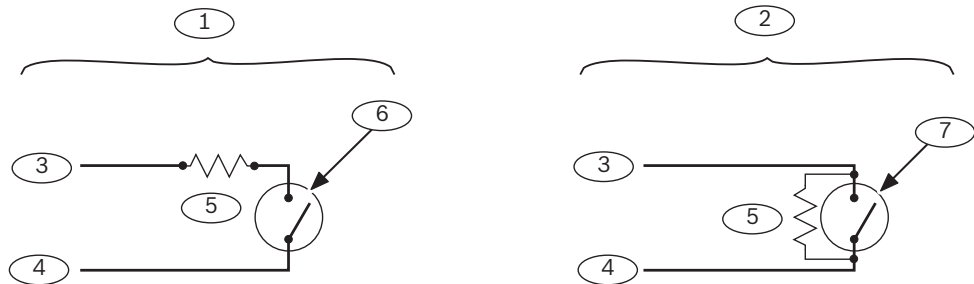

Callout — Description	Callout — Description
1 — Maintained keyswitch	5 — EOL (End of Line) resistor
2 — Momentary keyswitch	6 — Open on the circuit arms the area
3 — Common	7 — Momentary short on the circuit toggles the arming state
4 — Point input	



Notice!

UL requirement

Keyswitches are not intended for use in UL listed systems.

9.3 RADION keyfobs and Inovonics pendant transmitters



Notice!

UL 985 requirements for Household Fire Warning System Units

The standby times for all equipment in the transmission path (alarm, trouble, supervisory, and other signals) must have a backup power capacity of 24 hours.

The control panel supports one RADION keyfob or one Inovonics pendant transmitter for each user the control panel supports.

- B6512. Up to 10 wireless RADION keyfobs or 100 Inovonics pendant transmitters.
- B5512. Up to 50 wireless RADION keyfobs or 50 Inovonics pendant transmitters.
- B4512. Up to 32 wireless RADION keyfobs or 32 Inovonics pendant transmitters.
- B3512. Up to 10 wireless RADION keyfobs or 10 Inovonics pendant transmitters.

The control panel supports two RADION keyfob models, RFKF-FB-A and RFKF-TB-A, that communicate with the control panel using the B810 wireless receiver.

RADION keyfob FB

The RADION keyfob FB four button keyfobs are designed for arming (lock icon) and disarming (unlock icon) the system remotely. You can configure the programmable buttons at the control panel for additional control functionality. To operate the programmable buttons, simply press and hold either button for at least one sec in order for the desired feature to work.

- Uniquely coded arm and disarm buttons
- Panic alarm
- LED indicator
- Programmable option buttons

RADION keyfob TB

The RADION keyfob TB two button keyfobs are designed for arming (lock icon) and disarming (unlock icon) the system remotely. To operate these buttons, simply press and hold either button for at least one sec in order for the desired feature to work.

- Uniquely coded arm and disarm buttons
- Panic alarm
- LED indicator



Notice!

For specific installation and operation instructions, please refer to the RADION keyfob (RFKF-FB-TB/RFKF-FB-TB-A) Installation Guide and the RADION receiver SD (B810) System Reference Guide.

Custom functions and the RADION keyfob FB

Using RPS or the Installer Services Portal programming tool (available in Europe, Middle East, Africa, and China), you can assign two custom functions to a RADION keyfob FB, allowing a user to initiate the functions wirelessly. For more information, refer to RPS Help or the Installer Services Portal programming tool Help.

10 On-board outputs

The control panel provides one configurable (power, common, dry) and two open collector on-board outputs.

10.1 Circuit protection

The powered outputs come with circuit protection.

Three self-resetting circuit breakers protect the control panel from short circuits on the continuous and programmable power outputs. Each breaker protects a separate terminal:

- AUX (auxiliary power) terminal.
- C terminal of OUTPUT A.
- PWR/R terminal (power) of the SDI2 terminal block.



Notice!

UL requirement

Supervise devices powered from a power output.

10.2 Total available power

The control panel produces up to 800 mA of combined power at 12.0 VDC nominal to power peripheral devices. The outputs listed below and OUTPUT A share the available power.

AUX terminal (auxiliary power)



Power devices requiring continuous power (for example, motion detectors).

R/PWR terminal and power output of the interconnect connector (SDI2 power)

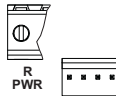

Power SDI2 devices such as keypads and octo-input modules.

Plug-in module connector

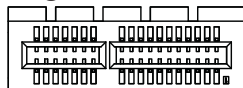

Connect plug-in modules such as the B444-A or B444-V.

OUTPUT A



Configure Output A as a dry contact (contact rating is 3 Amps), switched common (sink current), or a powered output. As a powered output, it can provide alarm power or switched auxiliary power. The default configuration for Output A makes it a powered output providing alarm power. Use OUTPUT PARAMETERS in RPS or in the Installer Services Portal programming tool (available in Europe, Middle East, Africa, and China) to configure programmable outputs.

10.3 Open collector outputs

OUTPUT B and C



Outputs B and C are open collector outputs that can sink up to 50 mA of power (+12 VDC), when activated.

As an example, the figure below shows using Outputs B and C to trigger the relays of a D134.

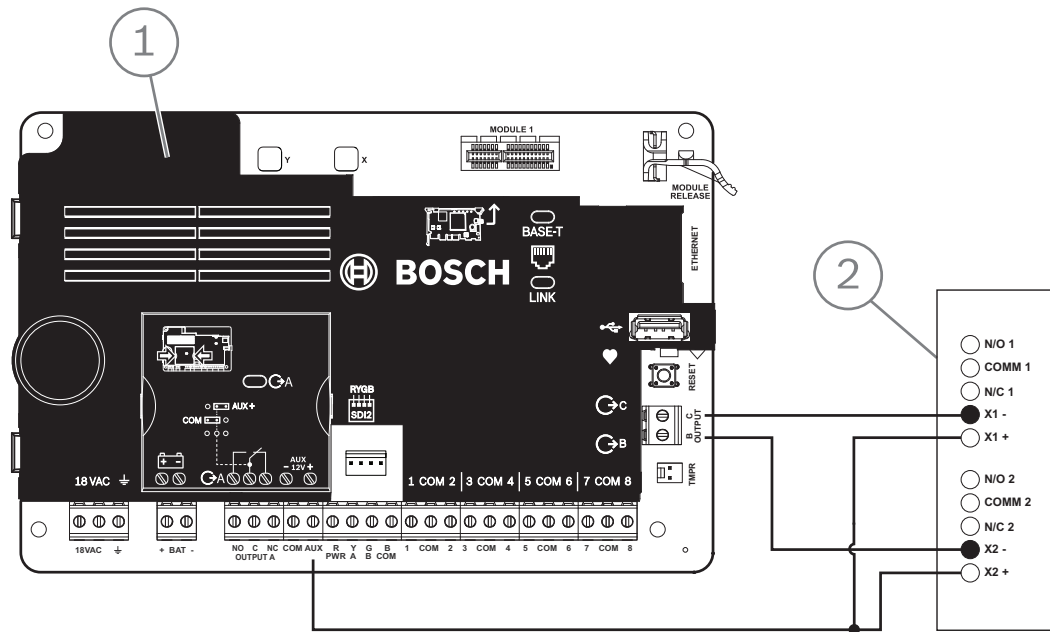

Figure 10.1: OUTPUT B and C wiring (B5512 shown)

Callout	Description
1	Control panel
2	D134 Dual Relay Module

- ▶ Use OUTPUT PARAMETERS in RPS or in Installer Services Portal programming tool (available in Europe, Middle East, Africa, and China) to configure programmable outputs.

11 Off-board outputs

The control panel supports off-board outputs with the B308.

11.1 B308 octo-output module

The B308 is an eight output expansion device that connects control panel through the SDI2 bus. It provides eight independently controlled outputs. Each output can operate as either normally open or normally closed.

You can configure the function for each output on the module individually. Refer to Output Parameters in RPS Help or in the Installer Services Portal programming tool (available in Europe, Middle East, Africa, and China) Help.

The control panels provide up to the following number of modules:

- B6512. 9 (72 outputs)
- B5512. 5 (40 outputs)
- B4512. 3 (24 outputs)
- B3512. Not supported

The module connects to the SDI2 bus on control panel using SDI2 terminals, or using the SDI2 interconnect wiring connector. You can connect more than one module to the control panel by wiring them in series.



Notice!

UL Commercial fire and intrusion devices

Do not connect fire and non-fire devices to the same B308.

For additional information on supported peripherals, refer to the technical documentation of these peripherals.

When using multiple NACs, the power for each D192G to support notification appliances must have its own power limited and isolated power from a UL864 listed supply, such that one NAC does not prevent another NAC from providing its alarm notification operation.

Outputs overview

Each module output provides a Form C dry contact rated for .001 to 1.0 A at 5 to 24 VDC (resistive load). Normally-open, common, and normally-closed terminals are available for each relay output. When an individual output is activated, continuity exists between the normally open and common terminals. When the output is not activated, continuity exists between the normally closed and common terminals.

11.1.1 SDI2 address settings



Notice!

The module reads the address switch setting only during module power up. If you change the setting after you apply power to the module, you must cycle the power to the module in order for the new setting to take effect.

If multiple B308 modules reside on the same system, each B308 module must have a unique address.

The number of outputs allowed by the control panel determines the valid addresses.

For valid output numbers, refer to *B308 address settings, page 132*.

11.1.2 Supervision

The control panel enables supervision of B308 modules on the SDI2 bus when the Output Source of an off-board output is set to Octo-output.

With any failure to receive an expected response from the module, all keypads show a system fault. The control panel sends a module trouble report to the central station (if configured for module trouble reports).

11.1.3

Installation and control panel wiring (B308)

Calculate power consumption

Make sure that there is enough power for the module and the other powered devices that you want to connect to the system.

Refer to *On-board outputs*, page 49.



Caution!

Remove all power (AC and battery) before making any connections. Failure to do so might result in personal injury and/or equipment damage.



Notice!

Enclosure

Install the module in the enclosure with the control panel or in an adjacent enclosure that is within the distances rated for the module: 400 ft (137 m) with 22 AWG (0.6 mm) wire or 1000 ft (305 m) with 18 AWG (1.0 mm) wire.

Installing the module

1. Set the module address.
2. Hold the module mounting brackets onto the inside of the enclosure. Match the bracket holes to a 3-hole mounting pattern on the enclosure
3. Use the supplied mounting screws to secure the module.

Wiring to the control panel

Use either the terminal strip labeled with PWR, A, B, and COM on the module to wire to the SDI2 terminals labeled on the control panel, or use the interconnect wiring connector and the included interconnect cable.

For terminal wiring, use 18 AWG to 22 AWG (1.0 mm to 0.6 mm) wire.



Notice!

Use either the terminal strip wiring or interconnect wiring to the control panel. Do not use both. When you connect multiple modules, you can combine terminal strip and interconnect wiring connectors in parallel.

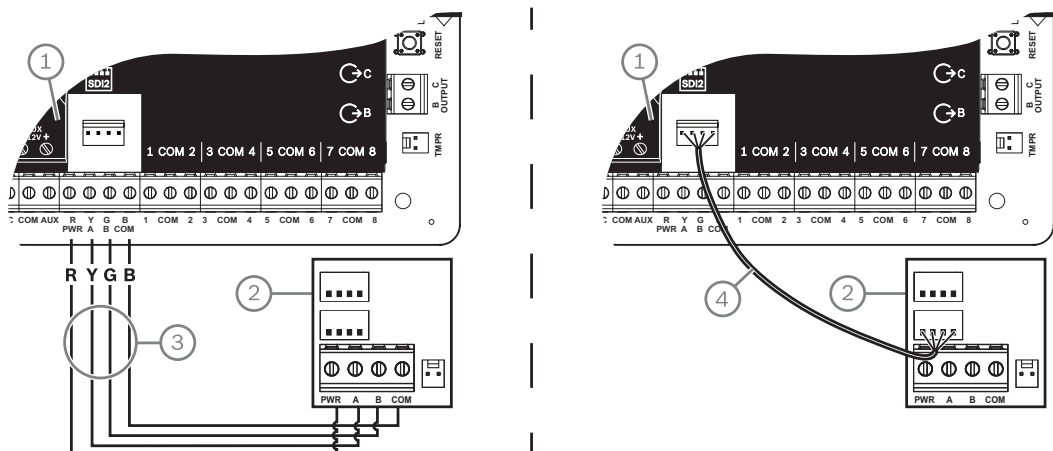

Callout — Description
1 — Control panel
2 — Module
3 — Terminal strip wiring
4 — Interconnect cable (P/N: F01U079745) (included)

12 On-board points

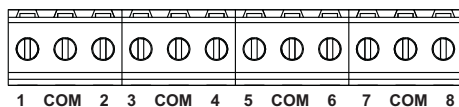

The control panel provides eight on-board points. Each point functions independently and does not interfere with the operation of the others. The control panel monitors the sensor loops for the following conditions between an input terminal and any of the point common terminals:

- Normal
- Shorted
- Open

The programming for the point determines how the control panel responds to those conditions.

The control panel ignores sensor loops (both on-board and off-board) for 60 seconds after power up to make sure that any connected devices stabilize.



Caution!

Points programmed as fire supervisory points are latching. A latching point requires that you acknowledge it before you can clear it.

12.1 Point sensor loops

You can configure each sensor loop for a single EOL resistor, or for dual EOL resistors. Single EOL resistor is the default. For dual EOL resistors, set the Point Profile > Circuit Style parameter to dual.



Notice!

You do not need to install the EOL resistor for unused points (Point Profile parameter set to 0 [zero]).

UL does not permit normally closed loops for commercial fire applications.



Notice!

Optionally use these points for household fire applications. You can connect four-wire detectors to these points, for example.

12.1.1 Single EOL (and no EOL) resistor circuit style

For the single EOL resistor circuit style, install the resistor at the far end of the sensor loop to provide a reference for supervision. You can connect dry contact sensing devices in series (normally closed) or in parallel (normally open) to any of these loops.

The number of normally open and normally closed detection devices each sensor loop can supervise is limited only by the resistance on the loop. The total resistance for the wire length and contacts, excluding the end-of-line (EOL) resistor, must not exceed 100 Ω .

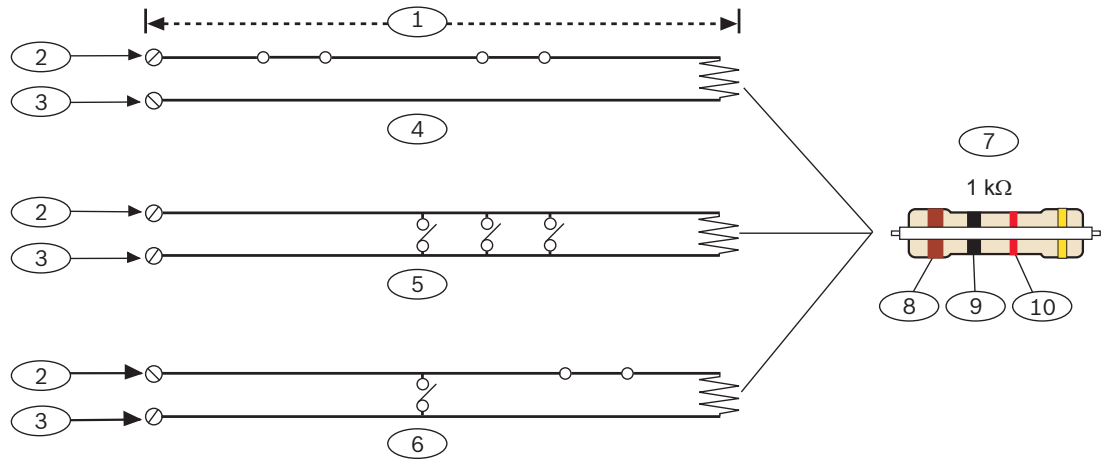

Callout — Description
1 — 100 Ω maximum
2 — Point input terminal
3 — Common
4 — Normally closed contacts (NC)
5 — Normally open contacts (NO)
6 — Combination: Normally open contacts and normally closed contacts (NO/NC)
7 — 1 kΩ EOL resistor (ICP-1K22AWG-10)
8 — Brown
9 — Black
10 — Red

Point voltage parameters

Refer to *Specifications, page 129*.

12.1.2 Dual EOL resistor circuit style



Notice!

EOL resistors

For the dual EOL resistor circuit style order ICP-1K22AWG-10, package of 10 1.0 kΩ EOL resistors.

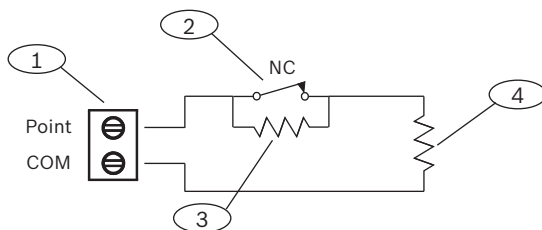

Callout - Description
1 - Point sensor loop terminals
2 - Normally closed device (contact)

Callout - Description
3 - 1.0 kΩ resistor at device
4 - 1.0 kΩ resistor at EOL (end-of-line)

12.2 Point response time

The control panel scans on-board and off-board point sensor loops every 250 milliseconds. In RPS or in the Installer Services Portal programming tool (available in Europe, Middle East, Africa, and China), the Debounce parameter in the Point Assignment section sets the point response time. Set the length of time the control panel scans a point before the control panel sends an alarm.

The debounce time can range from 250 milliseconds to 6.15 seconds. The default for Debounce is 820 ms.



Notice!

Before you increase the Debounce time

Increasing Debounce time might cause missed alarms. If you increase the Debounce time, detection devices can enter alarm and reset without exceeding the point response time.

Debounce does not apply to points with the Point Source configured as Wireless, Output, or IP Camera.

13 Off-board points

The control panel supports off-board points using the B208.

13.1 B208 octo-input module

The B208 is an eight point expansion device that connects to the control panel through the SDI2 bus. This module is supervised and communicates back to the control panel all point status changes. The module points work in the same way as the points on the control panel.

The control panels provide up to the following number of modules:

- B6512. 9
- B5512. 4
- B4512. 2
- B3512. Not supported

The module connects to the SDI2 bus on control panel using SDI2 terminals, or using the SDI2 interconnect wiring connector. You can connect more than one module to the control panel by wiring them in series.



Notice!

UL commercial fire and intrusion devices

Do not connect fire and non-fire devices to the same B308.

For additional information on supported peripherals, refer to the technical documentation of these peripherals.

When using multiple NACs, the power for each D192G to support notification appliances must have its own power limited and isolated power from a UL864 listed supply, such that one NAC does not prevent another NAC from providing its alarm notification operation.

13.1.1 SDI2 address settings



Notice!

The module reads the address switch setting only during module power up. If you change the setting after you apply power to the module, you must cycle the power to the module in order for the new setting to take effect.

If multiple B208 modules reside on the same system, each B208 module must have a unique address.

The control panel model determines the number of points allowed and the valid addresses. For valid point and address numbers, refer to *B208 address settings, page 132*.

13.1.2 Supervision

The control panel automatically enables supervision of B208 on the SDI2 bus when an associated point has its source programmed for Octo-input.

With any failure to receive an expected response from the module, all keypads show a system fault. The control panel sends a module trouble report to the central station (if configured for module trouble reports).

13.1.3 Installation and control panel wiring (B208)

Calculate power consumption

Make sure that there is enough power for the module and the other powered devices that you want to connect to the system.

Refer to *On-board outputs, page 49*.

**Caution!**

Remove all power (AC and battery) before making any connections. Failure to do so might result in personal injury and/or equipment damage.

Use either the terminal strip labeled with PWR, A, B, and COM on the module to wire to the SDI2 terminals labeled on the control panel, or use the interconnect wiring connector and the included interconnect cable.

For terminal wiring, use 18 AWG to 22 AWG (1.0 mm to 0.6 mm) wire.

**Notice!**

Use either the terminal strip wiring or interconnect wiring to the control panel. Do not use both. When you connect multiple modules, you can combine terminal strip and interconnect wiring connectors in parallel.

**Notice!****Enclosure**

Install the module in the enclosure with the control panel or in an adjacent enclosure that is within the distances rated for the module: 1000 ft (305 m) with 18 AWG to 22 AWG (1.0 mm to 0.6 mm) wire.

Installing the module

1. Set the module address.
2. Hold the module mounting brackets onto the inside of the enclosure. Match the bracket holes to a 3-hole mounting pattern on the enclosure
3. Use the supplied mounting screws to secure the module.

Wiring to the control panel

Use either the terminal strip labeled with PWR, A, B, and COM on the module to wire to the SDI2 terminals labeled on the control panel, or use the interconnect wiring connector and the included interconnect cable.

For terminal wiring, use 18 AWG to 22 AWG (1.0 mm to 0.6 mm) wire.

**Notice!**

Use either the terminal strip wiring or interconnect wiring to the control panel. Do not use both. When you connect multiple modules, you can combine terminal strip and interconnect wiring connectors in parallel.

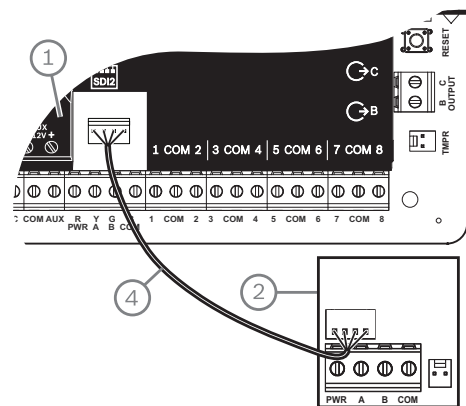
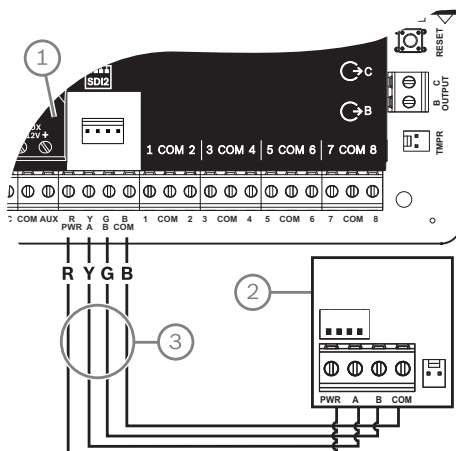

Callout — Description
1 — Control panel
2 — Module
3 — Terminal strip wiring
4 — Interconnect cable (P/N: F01U079745) (included)

13.1.4 Sensor loops overview and wiring

The resistance on the loop sets the number of normally-open or normally-closed detection devices each sensor loop can supervise. Resistance on each sensor loop must be less than 100 Ω with the detection devices connected.

The module detects circuit conditions on its sensor loops and sends the conditions to the control panel. Each sensor loop has an assigned point number.

Use twisted-pair wire for the module sensor loops to avoid electromagnetic interference problems. Run wires away from the premises telephone and AC wiring.

Sensor loop terminals are labeled 1 through 8. Terminals 1 and 2, 3 and 4, 5 and 6, and 7 and 8 share common terminals. The common terminals for each pair are labeled COM.

You can configure each sensor loop for a single EOL resistor, or for dual EOL resistors. Single EOL resistor is the default. For dual EOL resistors, set the Point Profile > Circuit Style parameter to dual.



Notice!

You do not need to install the EOL resistor for unused points (Point Profile parameter set to 0 [zero]).

UL does not permit normally closed loops for commercial fire applications.



Notice!

Optionally use these points for household fire applications. You can connect four-wire detectors to these points, for example.

Single EOL resistor circuit style

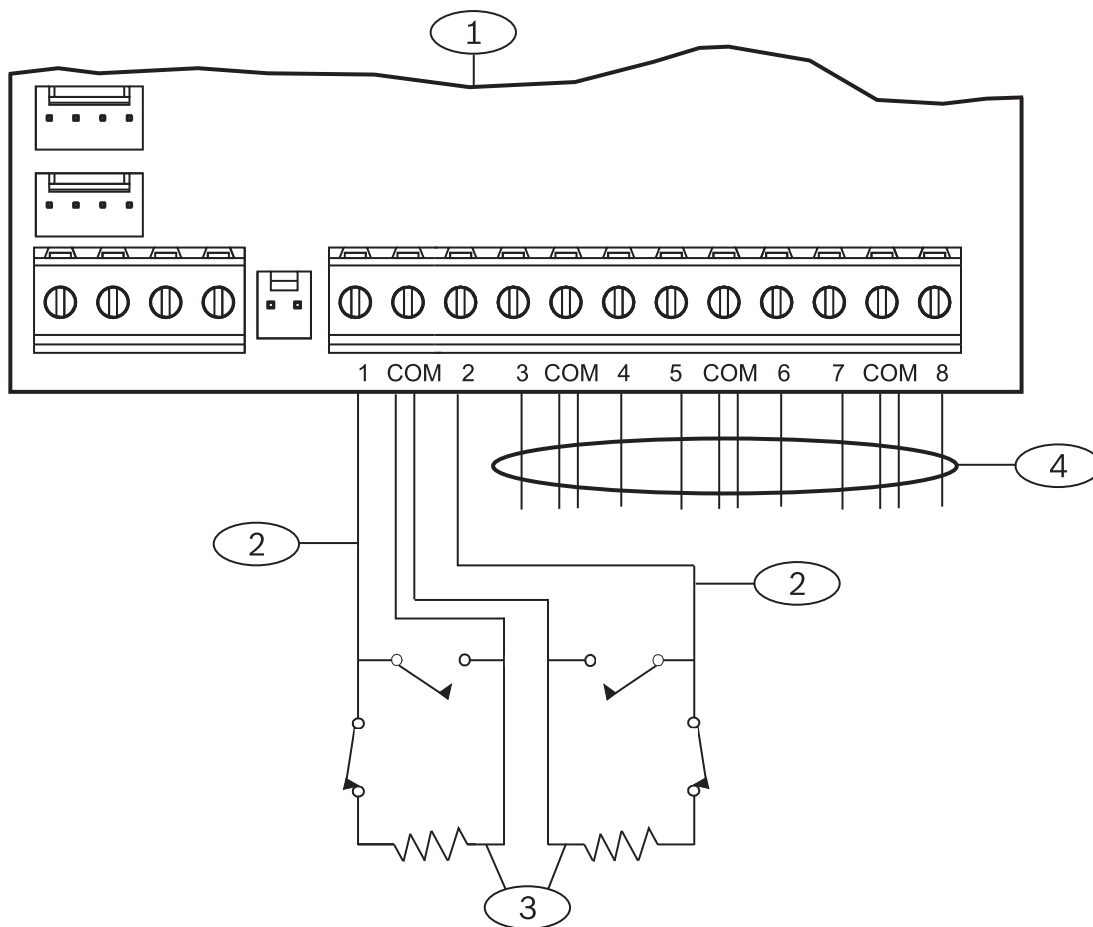

Callout — Description
1 — Module
2 — Sensor loop
3 — EOL Resistor – 1.0 kΩ (2.0 kΩ and No EOL optional)
4 — Wiring to additional sensor loops

Dual EOL resistor circuit style



Notice!

EOL resistors

For the dual EOL resistor circuit style order ICP-1K22AWG-10, package of 10 1.0 kΩ EOL resistors.

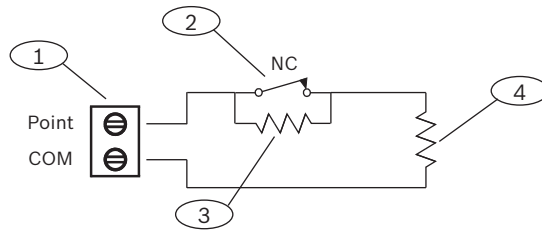

Callout - Description
1 - Point sensor loop terminals
2 - Normally closed device (contact)
3 - 1.0 kΩ resistor at device
4 - 1.0 kΩ resistor at EOL (end-of-line)

13.2

Off-board points test

Use the Service Walk Test to ensure that all off-board points operate properly.



Notice!

Walk test does not show extra points

If you set the address switches on off-board point modules, the control panel might create missing and extra points. If the address switches on two or more modules are set to the same address, the points associated with that address do not test correctly.

13.3

Extra Point events

The control panel generates Extra Point events when it detects a fault for an assigned point with its Point Profile set to 0 (disabled).

A wired point is considered assigned when its Point Source is set to Octo-input (SDI2).

An SDI2 Wireless point is considered assigned when its Point Source is Wireless and it has an RFID assigned.

On-board points cannot produce Extra Point events. Points that are Service Bypassed cannot produce Extra Point events.

13.4

Missing point conditions

Point programming and the state of the area that the point is in sets how the control panel operates. For example:

- An interior motion detector point is missing and the area is turned off (disarmed). The control panel makes a Missing Trouble event.
- An interior motion detector point is missing and the area is turned on (armed). The control panel makes a Missing Alarm event.

Non-fire, 24-hour points always make a Missing Alarm event. Fire points always make a Missing Fire Trouble event.

14 Wireless modules

The control panel supports one B810 or one B820. Use the module to add wireless sensors to the system.

14.1 B810 receiver

The B810 is a wireless receiver that supports RADION wireless devices and the RADION repeater. The receiver supports up to:

- 504 wireless point devices
- 1,000 keyfobs
- 8 repeaters

The module connects to the SDI2 bus on control panel using SDI2 terminals.

For additional information on supported peripherals, refer to the technical documentation of these peripherals.

When using multiple NACs, the power for each D192G to support notification appliances must have its own power limited and isolated power from a UL864 listed supply, such that one NAC does not prevent another NAC from providing its alarm notification operation.

14.1.1 SDI2 address settings



Notice!

The module reads the address switch setting only during module power up. If you change the setting after you apply power to the module, you must cycle the power to the module in order for the new setting to take effect.

The control panel supports only address 1.

14.1.2 Supervision

The control panel enables supervision of the module when you enroll at least one RF device. Available RF devices on the control panel include RF Repeaters, wireless points, or user keyfobs. Any failure to receive an expected response from an SDI2 module results in a system fault display on all keypads and a fault event sent to the central station.

14.1.3 Installation and control panel wiring (B810)

Calculate power consumption

Make sure that there is enough power for the module and the other powered devices that you want to connect to the system.

Refer to *On-board outputs*, page 49.



Caution!

Remove all power (AC and battery) before making any connections. Failure to do so might result in personal injury and/or equipment damage.

Installing the module



Notice!

Install the receiver in a location away from metal, near transmitters

Metal objects (duct work, wire mesh screens, boxes) reduce RF range.

For best receiver reception, install the receiver near the transmitters.

1. Open the module.
2. Use the address switch to set the module to address 1.

3. Use the provided anchors and screws to mount the module base on the wall.
4. Pull the wiring through the mounting plate.
5. Put the module on the base.

Wiring to the control panel

Use the terminal strip labeled with PWR, A, B, and COM on the module to wire to the SDI2 terminals labeled on the control panel. Wire the module within the distances rated for the module: 600 ft. (183 m) with 22 AWG (0.6 mm) wire or 1000 ft. (305 m) with 18 AWG (1.0 mm) wire.

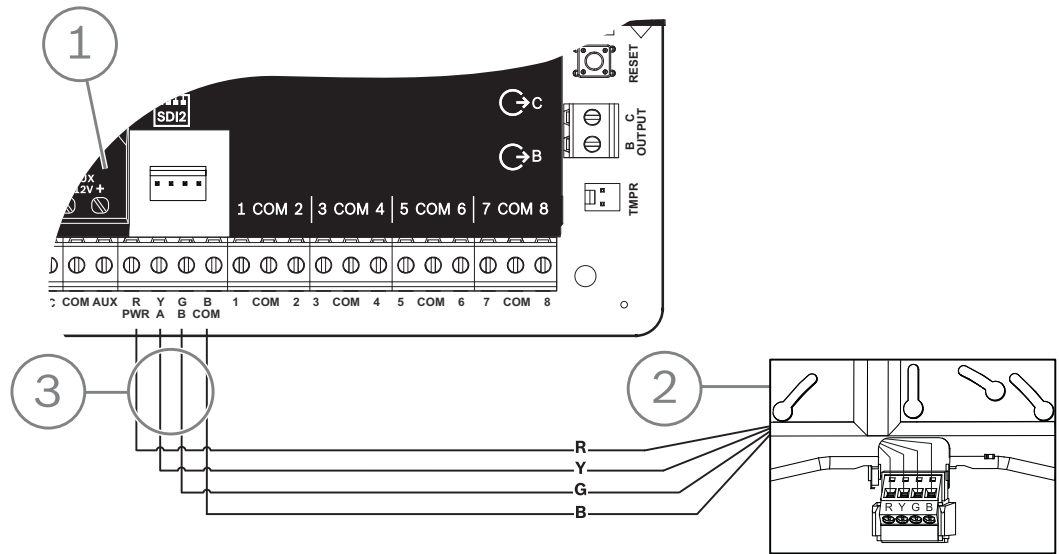

Callout — Description
1 — Control panel
2 — Module
3 — Terminal strip wiring

14.2 B820 SDI2 Inovonics Interface Module

The B820 is a module to connect a control panel with an Inovonics EN4200 EchoStream Serial Receiver.

For additional information on supported peripherals, refer to the technical documentation of these peripherals.

When using multiple NACs, the power for each D192G to support notification appliances must have its own power limited and isolated power from a UL864 listed supply, such that one NAC does not prevent another NAC from providing its alarm notification operation.

14.2.1 SDI2 address settings



Notice!

The module reads the address switch setting only during module power up. If you change the setting after you apply power to the module, you must cycle the power to the module in order for the new setting to take effect.

The control panel supports only address 1.

14.2.2

Supervision

The control panel enables supervision of the module when you enroll at least one RF device. Available RF devices on the control panel include RF Repeaters, wireless points, or user keyfobs. Any failure to receive an expected response from an SDI2 module results in a system fault display on all keypads and a fault event sent to the central station.

14.2.3

Installation and control panel wiring (B820)

Calculate power consumption

Make sure that there is enough power for the module and the other powered devices that you want to connect to the system.

Refer to *On-board outputs*, page 49.



Caution!

Remove all power (AC and battery) before making any connections. Failure to do so might result in personal injury and/or equipment damage.

Installing the module

1. Set the module address using the address switch before you install it in the EN4200 housing.
2. Use the address switch to set the module address.
3. Use a slotted screwdriver to press the housing release tabs and open the housing.
4. Remove the backing from one side of the supplied Velcro piece to show the Velcro adhesive.
5. Put the adhesive side of the Velcro onto the back of the module.
6. Remove the other backing from the Velcro.
7. Insert the module into the housing.
8. Connect the serial ports on the B820 and EN4200.
9. Push gently on the B820 to make sure that the Velcro sticks.
10. Refer to the EN4200 EchoStream Serial Receiver Installation Instructions for mounting and wiring instructions for the receiver.

Wiring to the control panel

Use the terminal strip labeled with PWR, A, B, and COM on the module to wire to the SDI2 terminals labeled on the control panel. Wire the module within the distances rated for the module: 600 ft. (183 m) with 22 AWG (0.6 mm) wire or 1000 ft. (305 m) with 18 AWG (1.0 mm) wire.

- ▶ Route the cabling through the control panel enclosure, and through the EN4200 housing.

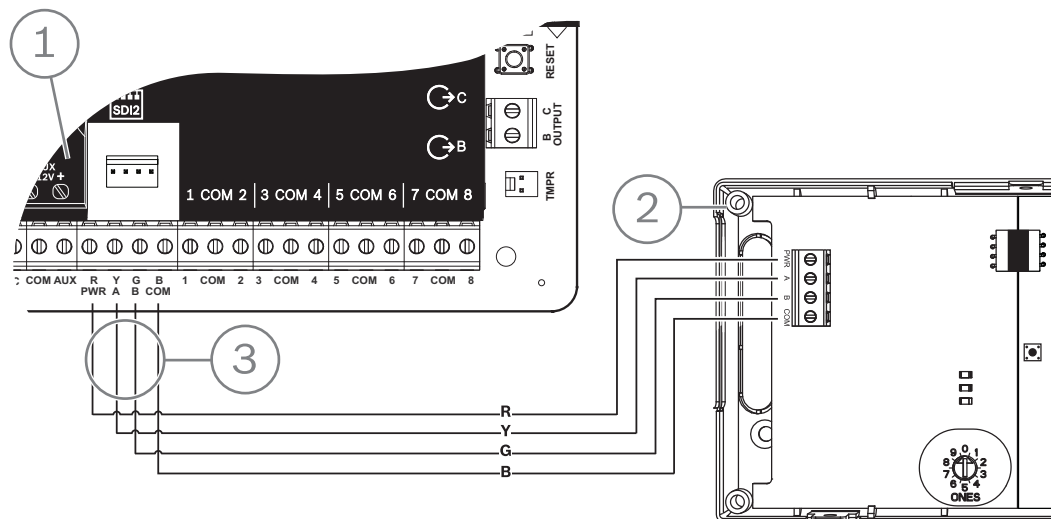

Callout — Description
1 — Control panel
2 — Module
3 — Terminal strip wiring

15 Access control

The B6512 control panel supports up to 4 B901 or D9210C modules. Use the module to add access control to the system.

Any of the following can grant access:

- Wiegand-style access control device (card reader) connected to the access control module
- Request to enter (RTE) or request to exit (REX) input
- Unlock command on an SDI2 keypad (excluding fire keypads)

The control panel access control features can deny access when the system is in On (armed). The control panel can also grant access only to certain authorized users depending on whether the area is all on, part on, or off. You can also program the system to automatically turn off (disarm) for authorized users.

The Dual Authentication feature can require a user to enter a passcode and present a card or token for access.

15.1 B901 door controller

The B901 Access Control Interface Module is a fully supervised, addressable SDI/SDI2 bus device that allows access control integration for Bosch compatible control panels. This module offers 14 programmable levels of access authority. Authority for access is controlled by the user level, the group of the user, the time of day, the door state, and the area armed state. Control each authority restriction through automatic and manual functions.

A door that has been automatically released by the control panel will require manually re-engaging to return to normal.

In a combination Fire/Intrusion system, the B901 should not be used to lock doors used for emergency egress unless these doors have a mechanical release mechanism.

The module connects to a B6512 SDI2 bus or using the interconnect wiring connector. You can connect more than one module to the control panel by wiring them in parallel. This section includes basic installation instructions.

For additional information on supported peripherals, refer to the technical documentation of these peripherals.

When using multiple NACs, the power for each D192G to support notification appliances must have its own power limited and isolated power from a UL864 listed supply, such that one NAC does not prevent another NAC from providing its alarm notification operation.

15.1.1 Address settings



Notice!

The module reads the address switch setting only during module power up. If you change the setting after you apply power to the module, you must cycle the power to the module in order for the new setting to take effect.

If multiple access control modules reside on the same system, each access control module must have a unique address.

For valid addresses, refer to *B901 address settings, page 133*.

15.1.2 Supervision

With any failure to receive an expected response from the module, all keypads show a system fault. The control panel sends a module trouble report to the central station (if configured for module trouble reports).

15.1.3 Installation and control panel wiring (B901)

Calculate power consumption

Make sure that there is enough power for the module and the other powered devices that you want to connect to the system.

Refer to *On-board outputs*, page 49.



Caution!

Remove all power (AC and battery) before making any connections. Failure to do so might result in personal injury and/or equipment damage.

Installing the module

1. Set the module address.
2. Hold the module mounting brackets onto the inside of the enclosure. Match the bracket holes to a 3-hole mounting pattern on the enclosure
3. Use the supplied mounting screws to secure the module.

Wiring to the control panel

Use either the terminal strip labeled with PWR, A, B, and COM on the module to wire to the SDI2 terminals labeled on the control panel, or use the interconnect wiring connector and the included interconnect cable.

For terminal wiring, use 18 AWG to 22 AWG (1.0 mm to 0.6 mm) wire.



Notice!

Use either the terminal strip wiring or interconnect wiring to the control panel. Do not use both. When you connect multiple modules, you can combine terminal strip and interconnect wiring connectors in parallel.



Notice!

B6512 only support

Only the B6512 supports the B901. Do not connect a the B901 to a B5512/B4512/B3512.

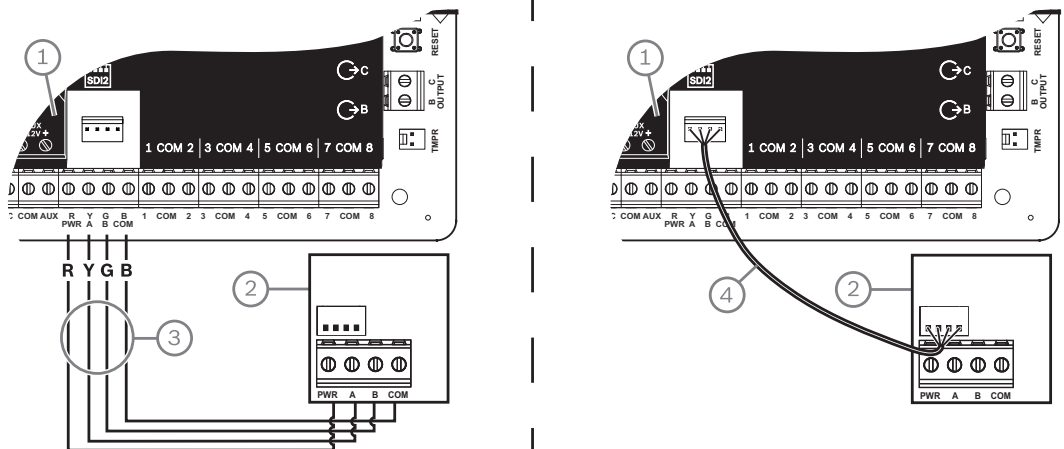

Callout — Description
1 — Control panel
2 — Module
3 — Terminal strip wiring

Callout — Description

4 — Interconnect cable (P/N: F01U079745) (included)

15.2**Card reader wiring**

To wire the access control module to a card reader, refer to the card reader instructions printed on or shipped with the reader.

16 Program and test the control panel



Notice!

After system installation and any control panel programming, perform a complete system test. A complete system test includes testing the control panel, all devices, and communication destinations for proper operation.

16.1 Program the control panel

Use RPS, the Installer Services Portal programming tool (available in Europe, Middle East, Africa, and China), or a keypad to program the control panel.

The following table shows the available languages for RPS and Installer Services Portal programming tool.

	Installer Services Portal programming tool	RPS programming	RPS custom text*
English	✓	✓	✓
Chinese	✓		
Dutch	✓		✓
French	✓		✓
German	✓		✓
Greek	✓		
Hungarian	✓		✓
Italian	✓		✓
Polish	✓		
Portuguese	✓		✓
Spanish	✓		✓
Swedish	✓		✓

* RPS custom text is text, that can be entered in RPS and which will then be displayed on keypads and on the mobile app.

16.1.1 Program the control panel with RPS

How to create an RPS panel account

1. Go to the RPS product page and download and install RPS v6.06 or later.
2. Follow the RPS Account Assistant instructions to create a new control panel account.

How to connect the control panel using RPS

1. Connect a computer with RPS installed. Direct RPS connections can be done through a USB connection or an Ethernet connection.
2. For a USB direct connection, use a B99 USB cable.
The RPS Account Assistant automatically launches when you create a new account.

How to configure and send to control panel using RPS

1. Program your configuration information using the RPS Account Assistant.
2. Click **close Account Assistant, and connect to control panel**.
3. The Panel Communication window opens.

4. Click **Connect** and send the configuration programming to the control panel.
 5. Click **Disconnect** when the programming is complete.
- For more information, refer to RPS Help.

16.1.2 Program the control panel with the Installer Services Portal programming tool

The Installer Services Portal programming tool is available in Europe, Middle East, Africa, and China.

How to create an Installer Services Portal programming tool panel account

1. Register for the Installer Services Portal at: <https://sp.boschsecurity.com>.
2. Make sure that the control panel is connected to the network.
3. Log into the Installer Services Portal programming tool.
4. To create a panel account, click on **New** and select **Device**.
5. Add the panel account information.
6. Activate the CloudID.
The Installer Services Portal programming tool searches the database for a registered ID.
7. Click **Activate**.
8. Click **Add Panel**.

How to connect and send using the Installer Services Portal programming tool

1. Search or select a device to connect to a control panel.
 2. To find a new account, type in the panel account name in the Search field.
 3. Select the panel account.
 4. Click **Connect**.
 5. Click **Configuration**.
 6. Program your configuration information.
 7. To send programming, click the 3 vertical dots and select **Push Pending Changes to Panel**.
 8. Click **Disconnect** when the programming is complete.
- For more information, refer to the Installer Services Portal programming tool Help.

16.1.3 Program the control panel with a keypad

Refer to *Keypad Installer menu*, page 97.

16.2 Walk tests

When you do a walk test, the control panel test the points assigned to areas in the scope of the keypad scope. During a walk test, the points do not work normally. The points only show that you tested them.

You can perform four different types of walk tests on this system. The tests terminate after 20 min of inactivity.

All point verification is disabled for all points during any walk test.

The control panel sends Walk Test Start and Walk Test End reports to the central station receiver.

16.2.1 Fire walk test

A fire walk test allows you to test **all** visible, 24-hr points.

A fire walk test includes multiple point types. Points must meet the following criteria:

- Have a point source other than Unassigned
- Have a point profile not set to Disabled (must be non-zero)
- Are not service bypassed
- Are not invisible points

- Have a point type of Keyswitch maintained, Keyswitch momentary, Open/Close Point, Fire, Aux AC Supervision, or Gas

Doing a fire walk test

1. Choose a keypad to conduct the test. Make sure that all areas are off (disarmed).
2. Open **Main Menu** and then go to the [3] **Actions Menu** > [3] **Test** > [1] **Walk Test** > [1] **Fire**.
3. The keypad shows the number of points that remain untested.
4. To view the list of points, press **Enter** or **View untested points**. To scroll through the list of points, use **←/Previous** or **→/Next**.
5. When you fault a point (press the test button on a smoke detector for example), the keypad emits a brief tone and shows the point name.



Notice!

Multiple detectors

If the point loop has multiple detectors, then the keypad emits a tone as confirmation for each fault detected.

16.2.2

Intrusion walk test

An intrusion walk test includes points meeting the following criteria:

- Have a point source other than Unassigned
- Have a point profile not set to Disabled (must be non-zero)
- Point type must be for a Controlled Point; Part-On, Interior, or Interior Follower
- Are not service bypassed
- Are not invisible points

A controlled point can be programmed for trouble when disarmed.

Performing an intrusion walk test

1. Choose a keypad to conduct the test. Make sure that all areas are off (disarmed).
2. Open **Main Menu** and then go to the [3] **Actions Menu** > [3] **Test** > [1] **Walk Test** > [1] **Intrusion**.
3. The keypad shows the number of points that remain untested.
4. To view the list of points, press **Enter** or **View untested points**. To scroll through the list of points, use **←/Previous** or **→/Next**.
5. When you fault a point (open a door for example), the keypad emits a brief tone and shows the point name and that it has been tested (for example, Pt-4: P4 Follow Tested).

16.2.3

Service walk test

A service walk test allows you to walk test points assigned to any point type. The area scope of the keypad that initiates the walk test determines which points are included in the test. All points are included when the keypad scope is panel wide, including those with a Point Profile of 0.

A service walk test includes points:

- with a point source other than Unassigned
- that are disabled (Point Profile set to 0) in addition to those that are enabled (non-zero Point Profile)
- that you have service bypassed

During a service walk test:

- The summary alarm and summary fire remain off, because there are no Fire or Burg alarm conditions to summarize.
- The test does not generate any Extra Point troubles.
- The test does not log any Extra Point events.

Performing a service walk test

1. Choose a keypad to conduct the test. Ensure that all areas are off (disarmed).
2. Open **Main Menu** and then go to the [3] **Actions Menu** > [3] **Test** > [1] **Walk Test** > [1] **Service**.
3. The keypad shows the number of points that remain untested.
4. To view the list of points, press **Enter** or **View untested points**. To scroll through the list of points, use **←/Previous** or **→/Next**.
5. When you fault a point (move in front of a motion sensor for example), the keypad emits a brief tone and shows the point name and information (for example, Area-1 Point-7 Onboard: Short).

16.2.4

Invisible walk test

An invisible walk test allows you to test both controlled points and 24-hr points. Points assigned to Point Profiles with the Invisible Point parameter set to Yes.

An invisible walk test includes points meeting the following criteria:

- Have a point source other than Unassigned
- Have a point profile not set to Disabled (must be non-zero)
- Have a point profile configured with the point type of 24-Hour, Part On, Interior, or Interior Follower
- Are not service bypassed

Performing an invisible walk test

1. Choose a keypad to conduct the test. Ensure that all areas are off (disarmed).
2. Enter your passcode and press **Enter**. The keypad shows the number of points that remain to be tested.
3. The keypad shows the number of points that remain untested.
4. To view the list of points, press **Enter** or **View untested points**. To scroll through the list of points, use **←/Previous** or **→/Next**.
5. When you fault a point (open a door for example), the keypad emits a brief tone and shows the name.

17 Control panel board overview

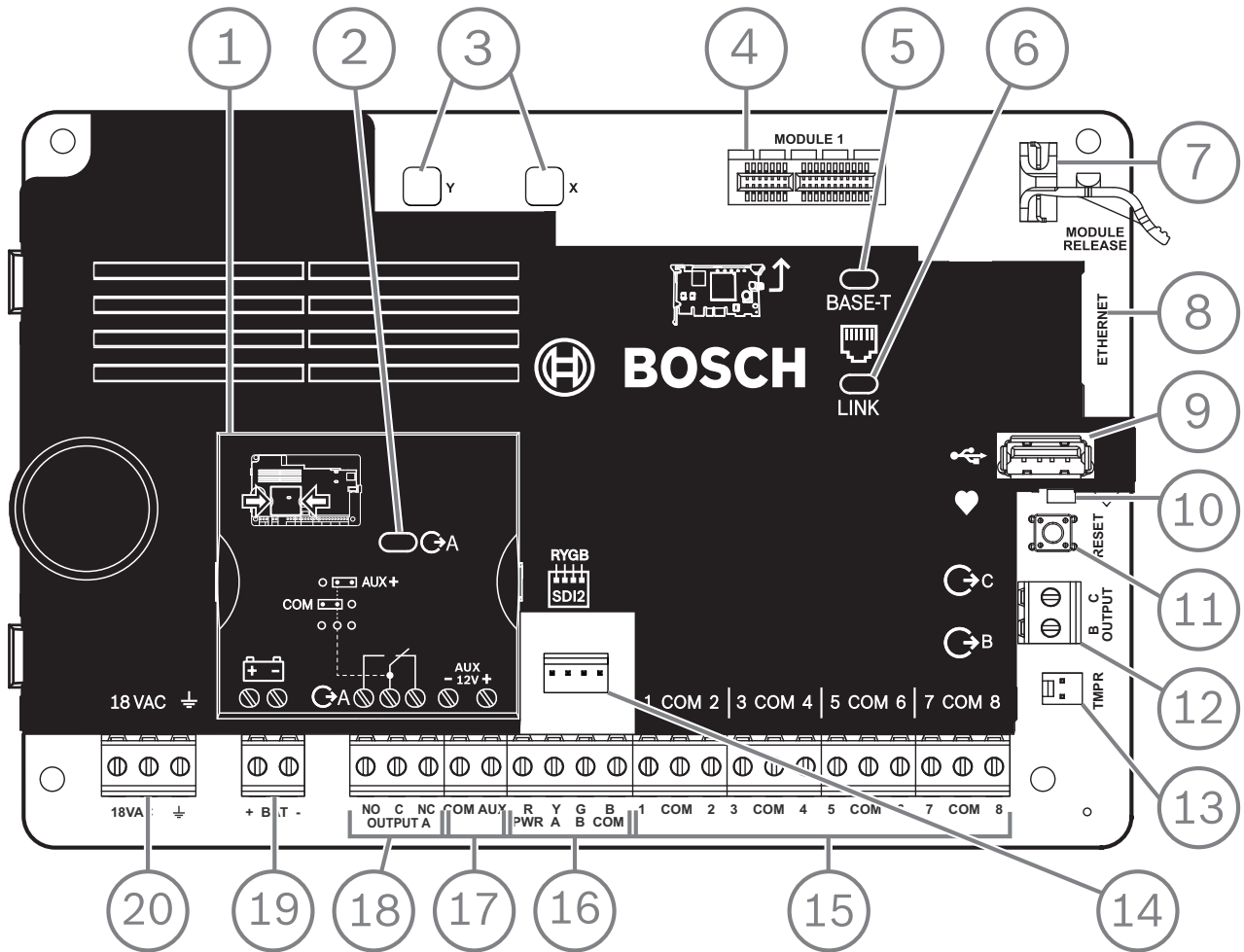

Figure 17.1: Control panel board overview (B5512 shown)

Callout — Description	For more information, refer to:
1 — Jumper to configure OUTPUT A	<i>OUTPUT A jumper, page 18</i>
2 — OUTPUT A LED	
3 — Holes to stabilize plug-in modules	<i>Installation and module wiring (B430), page 28 or Installation and module wiring (B44x)</i>
4 — Plug-in module connector	
5 — Green 100BASE-T LED	<i>On-board Ethernet diagnostic LEDs, page 33</i>
6 — Yellow LINK LED	
7 — Plug-in module retention clip	<i>Installation and module wiring (B430), page 28 or Installation and module wiring (B44x)</i>
8 — On-board Ethernet connector	<i>On-board Ethernet connection, page 32</i>
9 — USB connector	Programming
10 — Heartbeat LED (blue)	<i>Keypad Installer menu, page 97</i>
11 — RESET button	

Callout — Description	For more information, refer to:
12 — Terminals for Output B and Output C	<i>Open collector outputs, page 50</i>
13 — Tamper switch connector	<i>Installing the enclosure and wiring label, page 16</i>
14 — SDI2 interconnect wiring connector	SDI2 interconnect wiring
15 — Sensor loop terminals for points 1 to 8	<i>On-board points, page 54</i>
16 — SDI2 terminals (power and data)	<i>SDI2 devices general system wiring, page 80</i>
17 — Auxiliary power terminals	<i>On-board outputs, page 49</i>
18 — Terminals for OUTPUT A	<i>OUTPUT A jumper, page 18</i>
19 — Battery terminals	<i>Secondary (DC) power, page 20</i>
20 — 18 VAC power input terminals	<i>Primary (AC) power, page 20</i>

18 System wiring diagrams

18.1 System wiring overview



Notice!

UL Certificated accounts

Additional power can be obtained using only a UL Listed auxiliary 12.0 VDC regulated, power-limited power supply, such as the B520.

All terminals are power limited except BAT+ (battery positive).

All terminals are supervised except OUTPUT A, OUTPUT B, and OUTPUT C.

For proper supervision, do not loop wire under terminals. Break the wire run to provide supervision of connections.

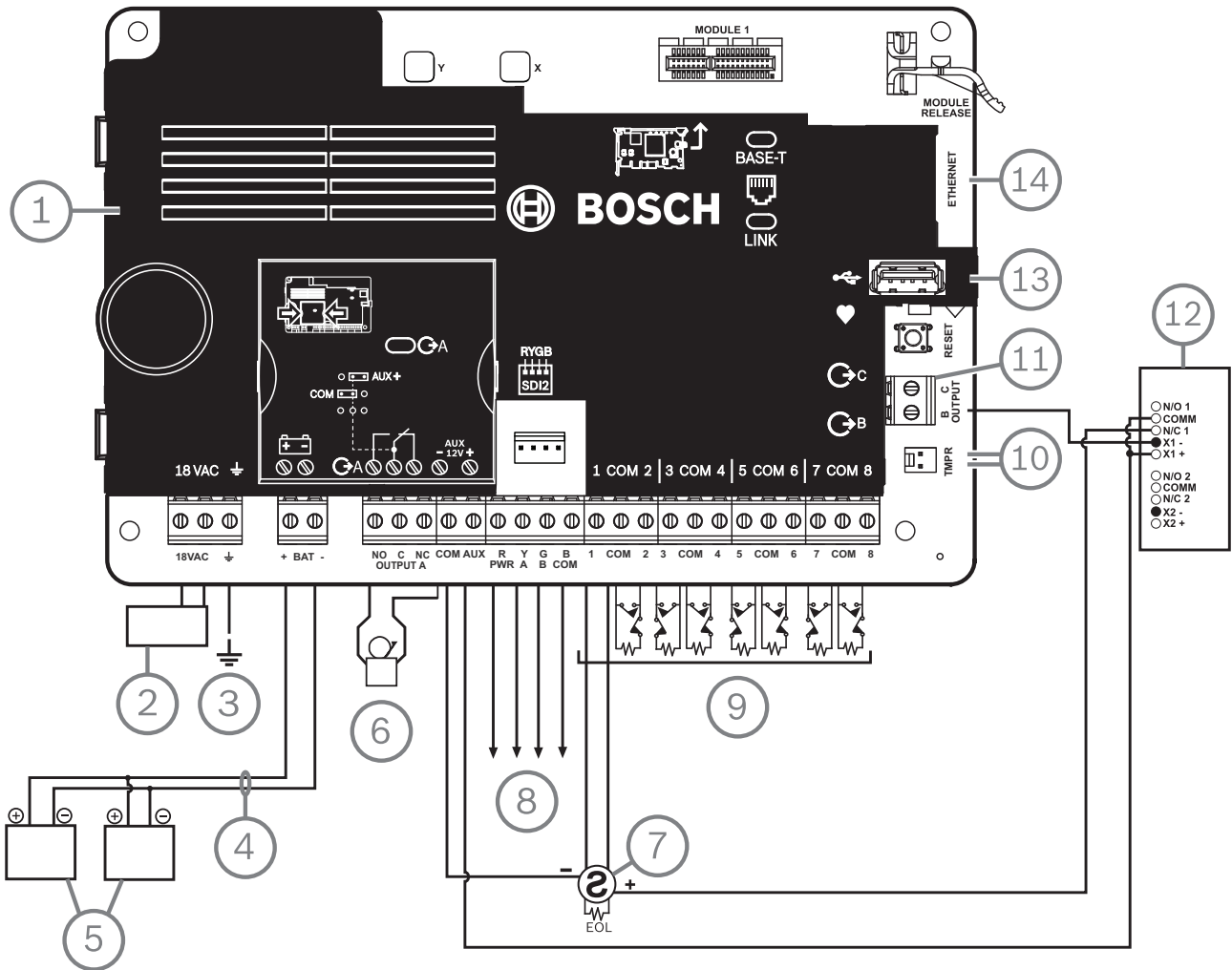

Callout — Description	Callout — Description
1 — Control panel	8 — SDI2 wiring
2 — UL listed class 2 transformer 18 VAC 22 VA 60 Hz (Canada: an ICP-TR1822-CA Plug-in Transformer 120 VAC primary, 18 VAC 22 VA secondary)	9 — Supervised sensor loops, points 1 to 8 (Initiating Device Circuits)
3 — To earth ground	10 — To ICP-EZTS Tamper Switch

Callout — Description	Callout — Description
4 — D122/D122L, as required	11 — Programmable outputs
5 — Batteries (unsupervised)	12 — External relay
6 — Audible signaling device	13 — USB connector
7 — UL Listed four-wire smoke detectors with EOL resistor	14 — RJ-45 modular jack for Ethernet (optional)

18.2 Battery lead supervision wiring

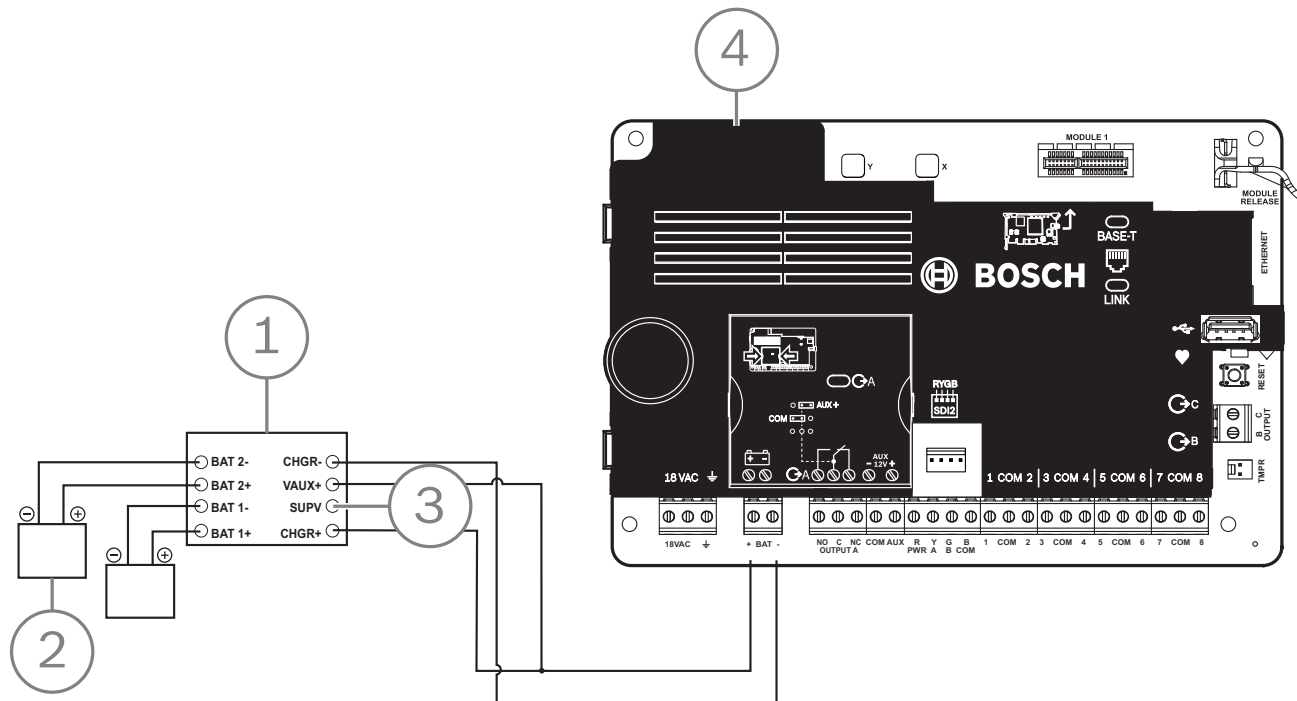

Callout — Description
1 — D113 Supervision module, battery lead, if required
2 — Batteries
3 — To supervision point
4 — Control panel

18.3 2-wire smoke wiring (B201)

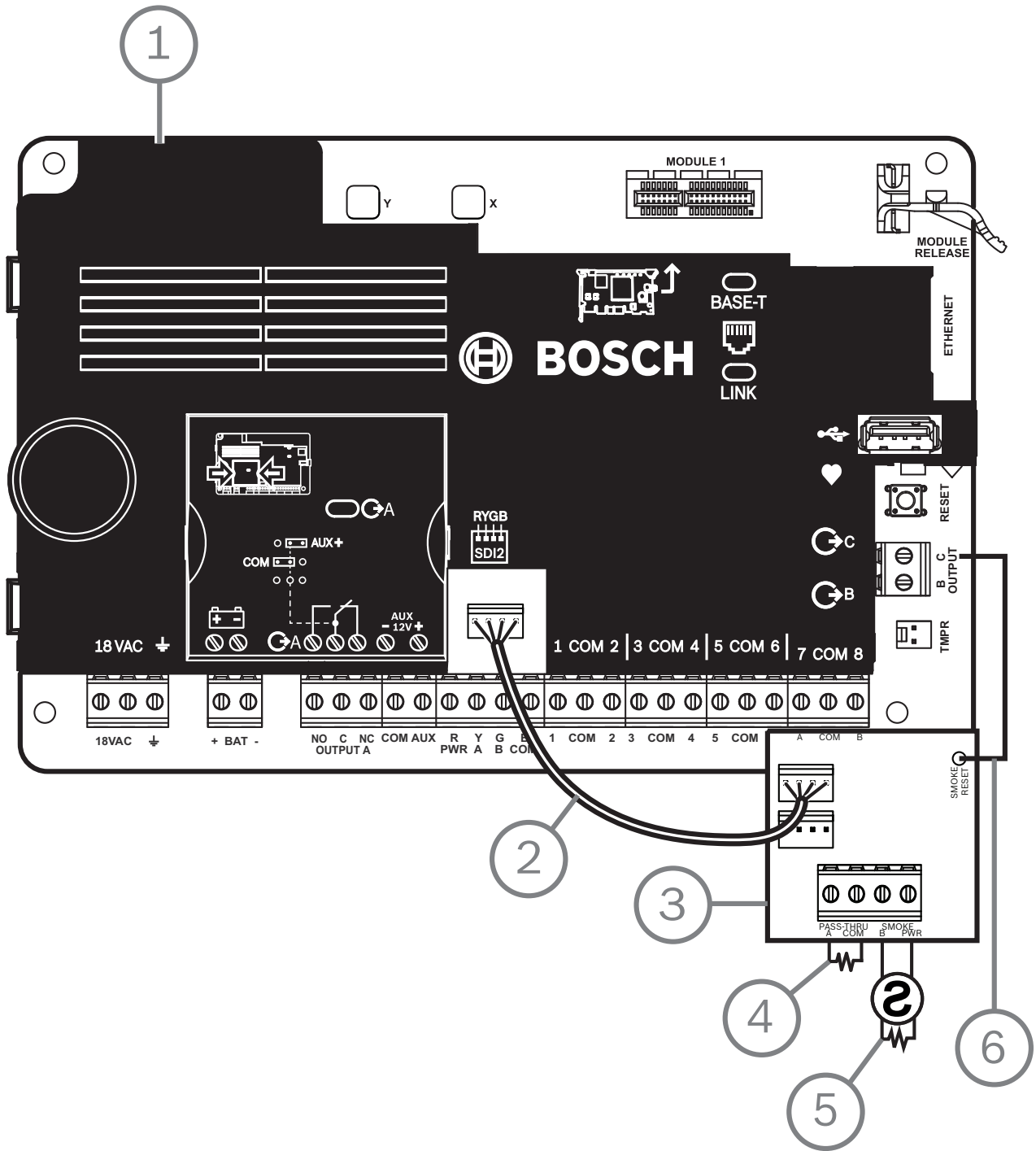

Callout — Description
1 — Control panel
2 — Interconnect wiring cable
3 — B201
4 — EOL resistor

Callout — Description
5 — 1.8 kΩ EOL resistor (P/N: F01U009011) (included with the module)
6 — Smoke reset wire

18.4 2-wire smoke wiring (D125B)

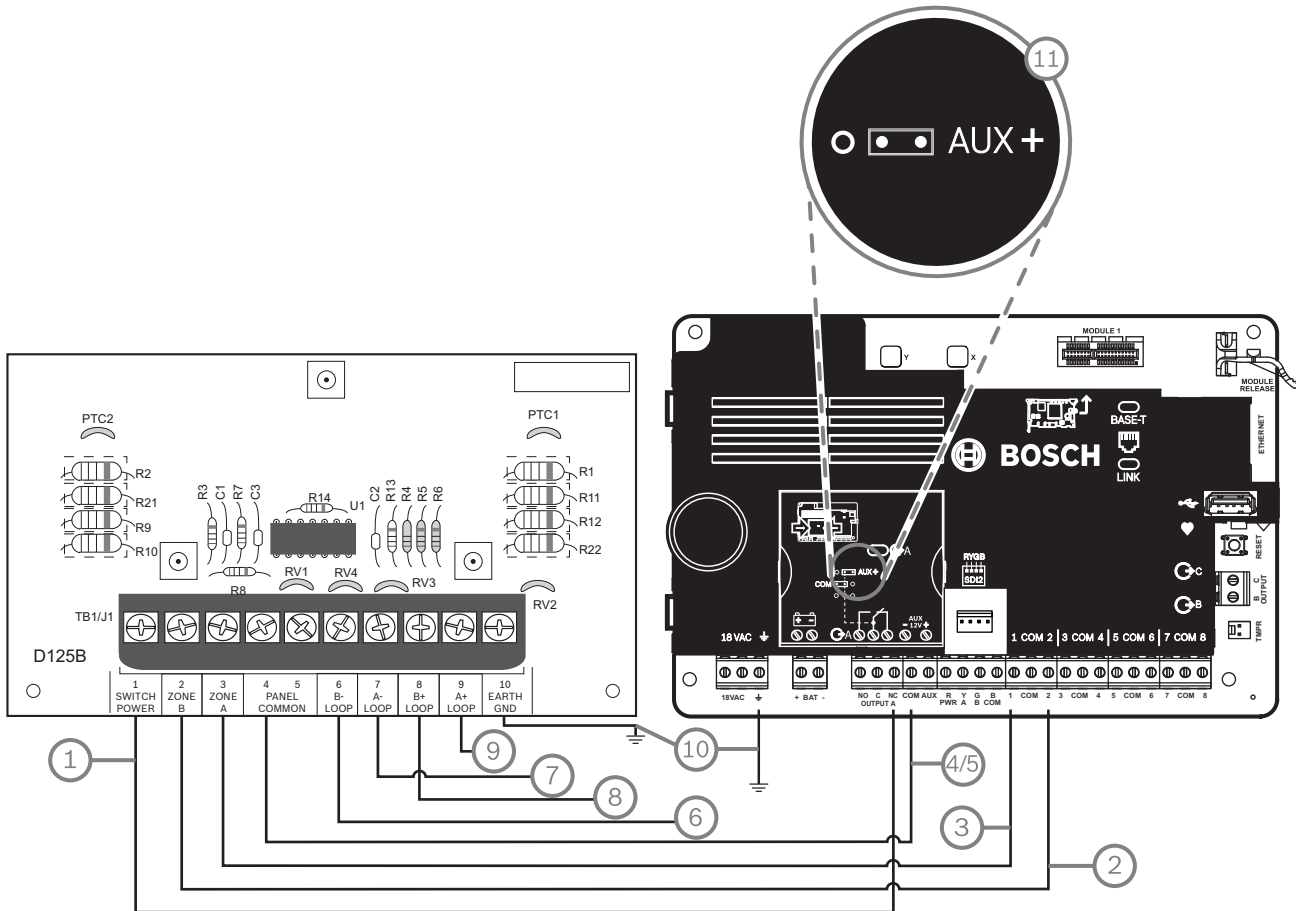

Callout — Description	Callout — Description
1 — Switched auxiliary power from Output A (NC) ¹ of the control panel	7 — Supervised smoke detector to A LOOP negative
2 — Connection from an on-board point on the control panel to Zone B	8 — Supervised smoke detector to B LOOP positive
3 — Connection from an on-board point on the control panel to Zone A	9 — Supervised smoke detector to A LOOP positive
4/5 — Connection to common on the control panel (one connection only)	10 — Earth ground
6 — Supervised smoke detector to B LOOP negative	11 — Output A jumper (under cover) set to AUX PWR

¹ You can also use Output B or C in conjunction with a D133 or D134 relay module.

18.5 Notification appliance circuit wiring

The control panel does not have an on-board NAC. For systems requiring a NAC, use a D192G.



Notice!

UL requirement

For UL Listed fire alarm applications, install a D192G.

For additional information on supported peripherals, refer to the technical documentation of these peripherals.

When using multiple NACs, the power for each D192G to support notification appliances must have its own power limited and isolated power from a UL864 listed supply, such that one NAC does not prevent another NAC from providing its alarm notification operation.

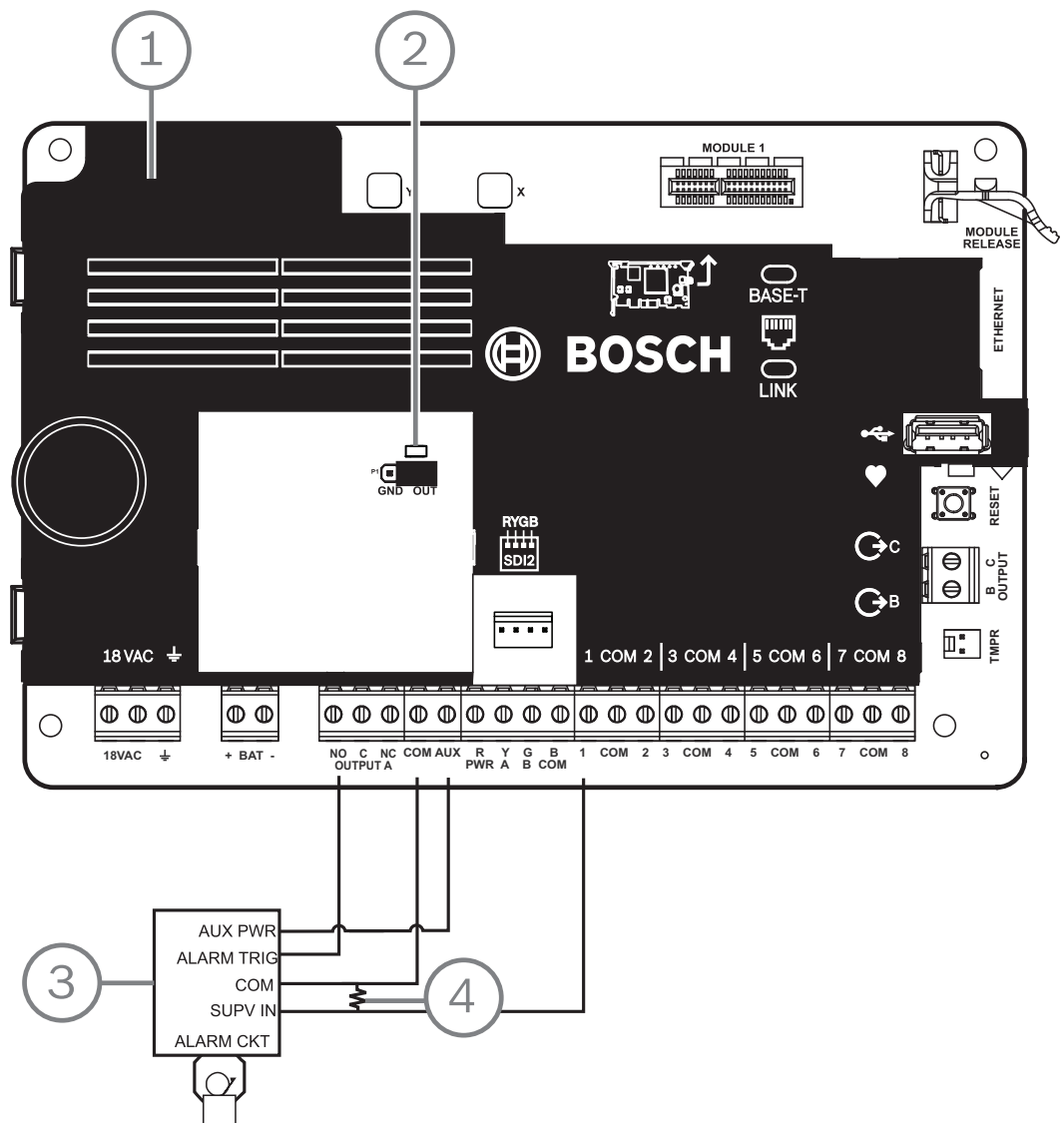

Callout — Description
1 — Control panel

2 — Output jumper set to configure OUTPUT A terminal C for AUX POWER (jumper cover removed)
3 — D192G
4 — 1k Ω EOL resistor (P/N: F01U033966)

18.6 SDI2 devices general system wiring

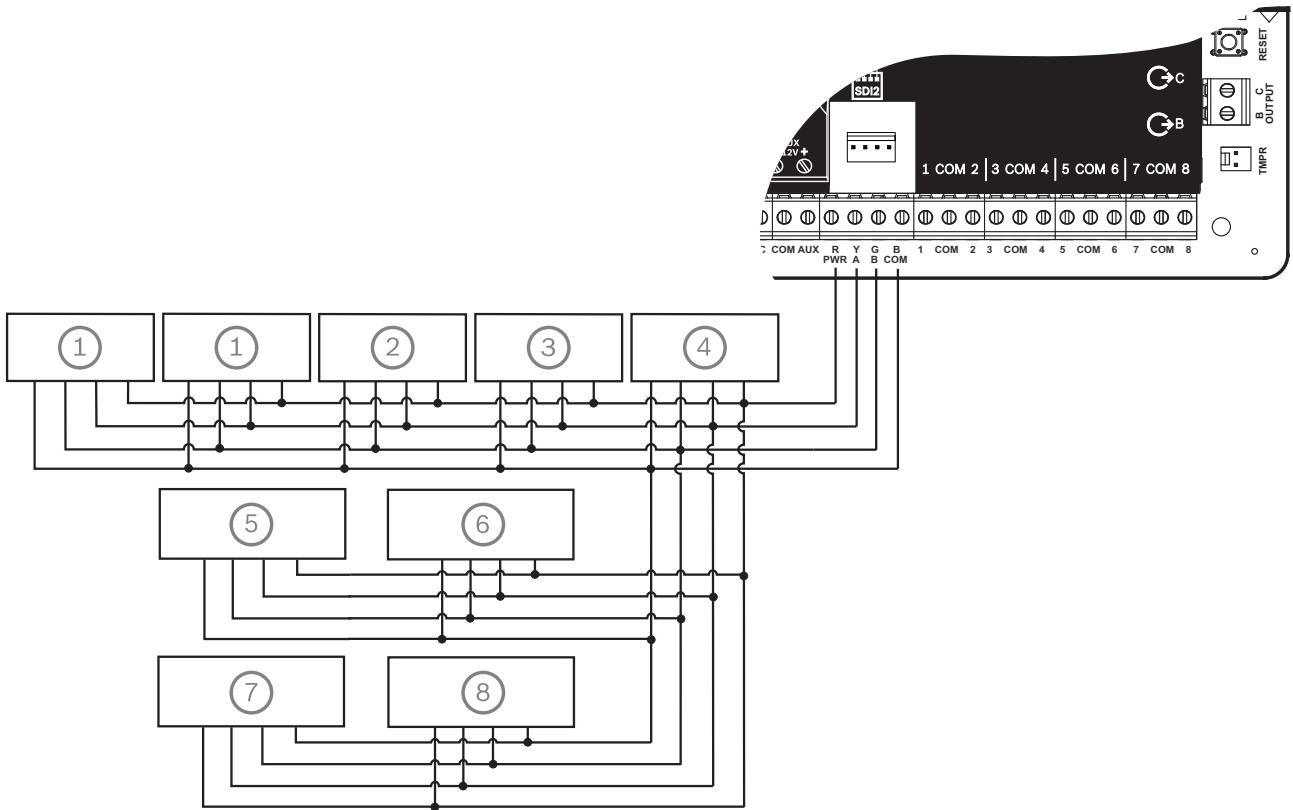

Callout — Description	B6512 capacity	B5512 capacity	B4512 capacity	B3512 capacity
1 — B208	9	4	2	0
2 — B308	9	5	3	0
3 — B426	1	1	1	1
4 — B450	1	1	1	1
5 — B520	4	4	2	2
6 — B810 or B820	1	1	1	1
7 — Compatible keypads	12	8	8	4
8 — B901	4	0	0	0



Notice!

The SDI2 power terminal (R/PWR) is power limited. The SDI2 terminals are supervised.

18.6.1 SDI2 bus wiring recommendations

Use the following SDI2 bus wiring recommendations for SDI2 installation. The control panel and SDI2 modules use the SDI2 bus to communicate with one another.

You can wire modules via home run, daisy chain, or single level T-tap anywhere on the SDI2 bus.

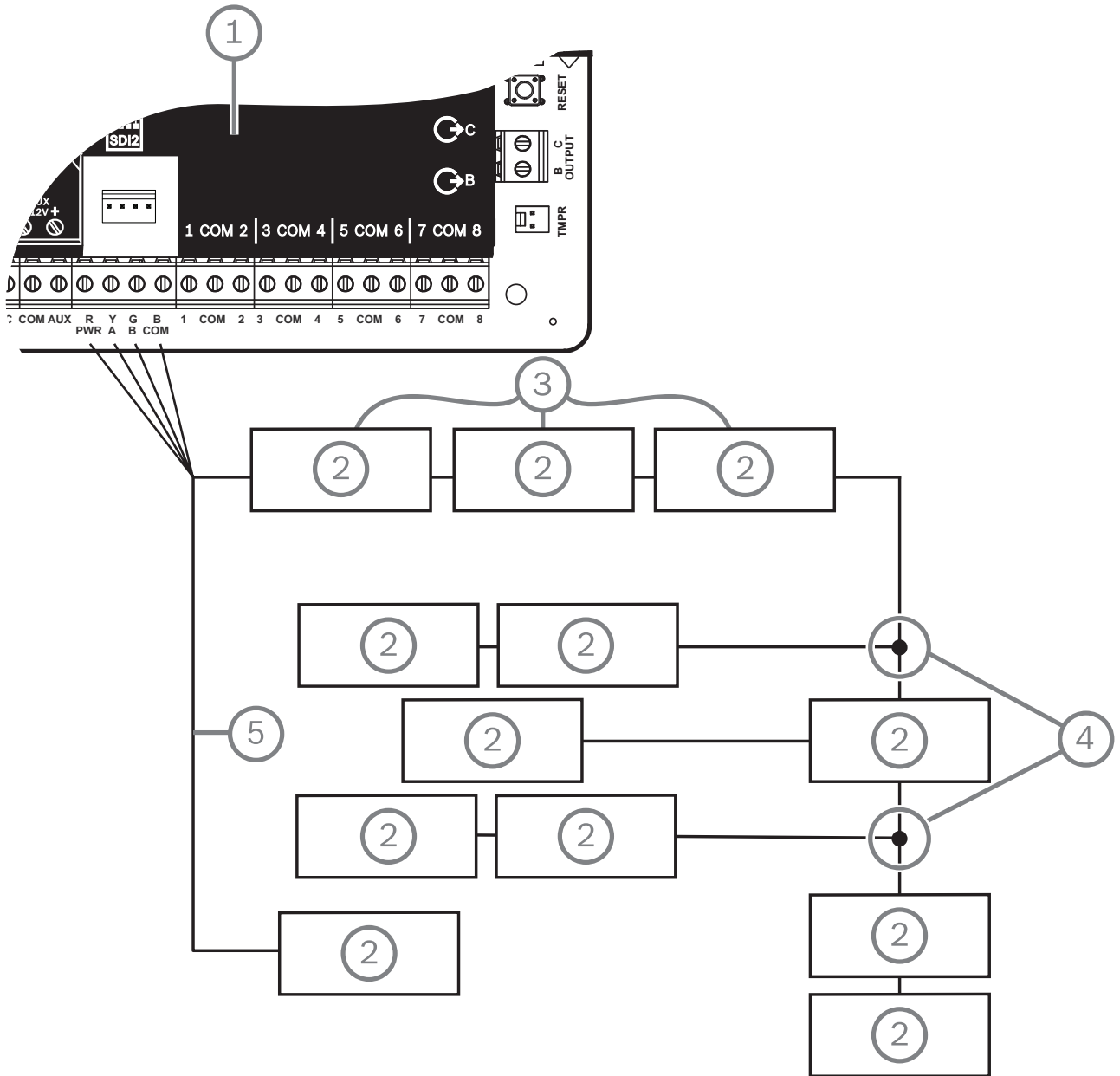

Figure 18.1: SDI2 bus wiring recommendations (B5512 shown)

Callout — Description
1 — Control panel
2 — SDI2 device (module or keypad)
3 — Daisy chain wiring
4 — Single-level T-tapped wiring

5 — Home run wiring



Notice!

There can only be a difference of 2 volts (maximum) between the AUX power terminals of the control panel or power supply and the device for the modules and keypads to work properly under all conditions.

Maximum cable lengths

Follow these rules when wiring the SDI2 bus:

- The SDI2 bus requires the use of **unshielded** cable from 12 AWG to 22 AWG (0.65 mm to 2 mm).
- Refer to the SDI2 device or keypad documentation for the allowable maximum distance from the control panel.
- Maximum overall cable lengths are listed in the following table:

Cable capacitance			Overall cable length			Cable capacitance			Overall cable length		
pF/ft	ft	m	pF/ft	ft	m	pF/ft	ft	m	pF/ft	ft	m
< 17	7500	2286	27	5185	1580	27	5185	1580	27	5185	1580
18	7500	2286	28	5000	1524	28	5000	1524	28	5000	1524
19	7350	2240	29	4828	1472	29	4828	1472	29	4828	1472
20	7000	2134	30	4700	1433	30	4700	1433	30	4700	1433
21	6666	2032	31	4516	1376	31	4516	1376	31	4516	1376
22	6363	1939	32	4400	1341	32	4400	1341	32	4400	1341
23	6086	1855	33	4242	1293	33	4242	1293	33	4242	1293
24	5800	1768	34	4100	1250	34	4100	1250	34	4100	1250
25	5600	1707	35	4000	1219	35	4000	1219	35	4000	1219
26	5385	1641	36	3800	1158	36	3800	1158	36	3800	1158

Table 18.9: Maximum cable length



Notice!

Use unshielded cable only.
 Maximum capacitance of 140nF (140,000 pF) per system. Contact the wire manufacturer for the capacitance ratings of the wire being used.

18.7 Wiring label

BOSCH

B6512/B5512/B4512/B3512

This equipment should be installed in accordance with the NFPA 70 (National Electrical Code), the NFPA 72 (National Fire Alarm Code), and the local authority having jurisdiction. Depending on the application, the installation is to be in accordance with one or more of the following UL standards:
 UL681 Installation and Classification of Mercantile and Bank Burglar Alarm Systems;
 UL1076 Proprietary Burglar Alarm Systems and Units; UL1641 Installation and Classification of Residential Burglar Alarm Systems. Printed information describing proper installation, operation, testing, maintenance, repair service and response to an alarm is to be provided with this equipment. Warning: Owner's Instruction Notice (P/N: F01U287181): Not to be removed by anyone except occupant. Avertissement : guide de l'utilisateur (ref. : F01U287181) : seul l'occupant est autorisé à le retirer.

Bosch Security Systems, Inc. recommends testing the entire system at least once a week, and having a qualified technician check the system at a minimum of once every 3 years.

Minimum system requirements for Classification in accordance with ANSI/SIA CP-01-2010
 UL Listed and Classified control unit Model B5512, B4512 or B3512;
 UL Listed and Classified keypad Model B915/B915i, B920, B921C, B930, B940W, B942, or B942W
 UL Listed Local Bell

Suitable for the following applications: 1) Household Burglar Alarm System Units. 2) Household Fire Warning System Units. 3) Police Station connect, Mercantile Premise alarm system, Mercantile Safe and Vault alarm system. For all Police Station applications, Model D8108A Attack Resistant Enclosure with a UL Listed local sounding device is required. 4) Local, Mercantile Premise alarm system and Mercantile Safe and Vault alarm system. 5) Central Station, suitable as a dual signal line transmission system. 6) Proprietary Burg. 7) Holdup Alarm Units and System.

This equipment has been type tested and found to comply with the specifications in Part 15 of FCC rules for Class B Computing Devices. Operation is subject to the two following conditions (1) this device may not cause any interference, and (2) this device must accept any interference received including interference that may cause undesired operation.

POWER SUPPLY REQUIREMENTS
 The Power Supply provides a maximum of 800 mA for the Control Panel and all Accessory Devices.
 All external connections are inherently power limited, Class 2.
 Requirements for battery standby time might reduce allowable output.

Model number B430 complies with Part 68, FCC Rules. FCC Registration Number: ESWAL00BB430 Ringer Eq 0.0B
 Model number B430 complies with CS-03, IC Rules, IC: 1249A-B430 REN 0.0

For ULC installations, refer to the ULC Installation Guide (P/N: F01U321698 for en and fr).

Incorrect wiring might damage this equipment.

Do not connect to a receptacle controlled by a switch. Do not share with other equipment.

B6512/B5512/B4512/B3512 use a CX4010 UL Listed Class 2 Transformer 18 VAC 22 VA 60 HZ, or in Canada, an ICP-TR1822-CAN Plug-in Transformer 120 VAC primary, 18 VAC 22 VA secondary.

CAUTION! AVERTISSEMENT!
 Avoid damage to Panel. Do not connect 24 V to terminals. Pout éviter d'endommager la centrale : Ne pas raccorder l'alimentation électrique de volts aux bornes.

Maximum charging current is 1 A auxiliary power at 12 VDC. BATTERY: Replace every 3 to 5 years with one or two D126 or one D1218 12 V Lead Acid Batteries for Burglary or Combination Fire and Burglary Systems.

WARNING! ATTENTION!
 Multi-Battery installation requires Model D122 or D122L Dual Battery Harness. Improper installation can be a fire hazard. Le installations à plusieurs batteries nécessitent un faisceau de câbles de Batterie double de modèle D122 ou D122L. Toute installation inadéquate peut causer un risque d'incendie.

For UL Listed fire alarm applications, use a D132G Notification Appliance Circuit module.

MODULE 1

Optional B440/B441/B442/B443 - Or - Optional B430

MOVIE RELEASE

(Optional) ETHERNET

ETHERNET

OUTPUT A (C terminal) = AUX PWR
 GND OUT

OUTPUT A (C terminal) = COM
 GND OUT

OUTPUT A (C terminal) = dry contact
 GND OUT

Interconnect Connector

18VAC + BAT -

NO C NC COM AUX R Y G B 1 2 3 4 5 6 7 8 COM 1 2 3 4 5 6 7 8

Earth Ground

Supervised Loops

Open 3.7 to 5.0 VDC
 Normal 2.0 to 3.0 VDC
 Short 0.0 to 1.3 VDC
 With 1 kΩ EOL Resistor (P/N:15093130-004). For other EOL options, refer to the UL Installation Guide (P/N: F01U287185).
 Typical Initiating Devices are Door Contacts NO/NC, Floor Mats, Motion Detectors, Glass Break Detectors, etc.

An EOL power supervision module might be required for use with 4-wire smoke detectors.

D134 Dual Relay Module
 ○ NO 1
 ○ COM 1
 ○ NC 1
 ● X1
 ● X1 +

○ NO 2
 ○ COM 2
 ○ NC 2
 ● X2
 ● X2 +

ICP-EZTS Tamper Switch

RESET

USB

ETHERNET

For a list of 2-wire smoke detectors compatible with the B201, refer to the B201 Installation Guide (P/N: F01U296412).

For a list of 2-wire smoke detectors compatible with the D125B Dual Class B Initiating Module, refer to the D125B Installation Instructions (P/N: F01U036340).

WARNING
 THIS UNIT INCLUDES AN ALARM VERIFICATION FEATURE THAT WILL RESULT IN A DELAY OF THE SYSTEM ALARM SIGNAL FROM THE INDICATED CIRCUITS. THE TOTAL DELAY (CONTROL PANEL PLUS SMOKE DETECTORS) SHALL NOT EXCEED 60 SECONDS. NO OTHER SMOKE DETECTOR SHALL BE CONNECTED TO THESE CIRCUITS UNLESS APPROVED BY THE LOCAL AUTHORITY HAVING JURISDICTION.

ATTENTION!
 CETTE UNITÉ COMPREND UNE FONCTIONNALITÉ DE VÉRIFICATION DES ALARMES QUI CONDUIT À UN RETARD DU SIGNAL D'ALARME DU SYSTÈME PROVENANT DES CIRCUITS INDICUÉS. LE RETARD TOTAL (CENTRALE + DÉTECTEURS DE FUMÉE) NE DOIT PAS DÉPASSER 60 SECONDES. NE CONNECTER AUCUN AUTRE DÉTECTEUR DE FUMÉE À CES CIRCUITS, SAUF SI CELA EST PERMIS PAR LES RÉGLEMENTATIONS LOCALES EN VIGUEUR

* Circuit (point)	Control panel delay, seconds	Smoke detector	
		Model	Delay, seconds

Include detector data or the following or equivalent statement: "Use the delay (power-up/start-up) time marked on the installation wiring diagram of the smoke detector or on the installed smoke detector(s)."

Auxiliary Powered Devices 11.5 to 12.4 VDC. Below 10.2 VDC, the B6512/B5512/B4512/B3512 stops processing Loop inputs.

This equipment should be installed in accordance with the CSA C22.1, Canadian Electrical Code, Part 1, Safety Standard for Electrical Installations.

B6512_B5512_B4512_B3512_ULLD-05

Communication:
 Standard Line Security: Cellular or IP
 A4: Cellular or IP
 P3: DACT

F01U287186-09A

19 Approved applications

The UL System Chart references the components that are evaluated and listed by UL for compatibility with B6512/B5512/B4512/B3512. These components meet the basic system requirements for the applicable standard.

Refer to *Compatible UL listed components, page 91*.

The system wiring diagrams show the relationship between the control panel and the accessory components.

Refer to *System wiring diagrams, page 75*.

19.1 Optional compatible equipment

You can use UL Listed components not requiring evaluation for electrical compatibility in many applications when installed according to the manufacturer's instructions.

19.1.1 Burglar applications

You can use UL Listed components not requiring evaluation for electrical compatibility in burglary applications. In some cases, you must use a UL Listed interface module with the sensors. Consult the individual component specification and installation documents to determine suitability.

19.1.2 Bank safe and vault applications

You must use the D8108A Attack-Resistant Enclosure to meet UL Standard 681.

Refer to *Rothenbuhler 5110/4001-42 High Security Bell overview, page 85* for wiring instructions and diagrams.

Control panel enclosure requirements

UL Standard 681 for Installation and Classification of Mercantile and Bank Burglary Alarm Systems requires foil lining or equivalent protection of the control unit enclosure. The D8108A Attack-Resistant Enclosure does not have a foil lining, but acceptable protection is provided by mounting electronic vibration sensors inside the enclosure.



Notice!

Proximity alarms

Do not use proximity alarms (capacitance) to protect the control panel enclosure.

1. Install the same electronic vibration sensors in the D8108A that are used to protect the safe or vault.
2. Mount the Sentrol 5402, Potter EVD-S, or Arrowhead S-3810 electronic vibration detection (EVD) system inside the D8108A to meet the UL 681 requirements.
3. Install and test the EVD sensor according to the manufacturer's instructions.
4. Mount the EVD sensor directly inside the metal cabinet of the D8108A.



Caution!

EVD installation

Do not install the EVD sensor within 6.4 mm (0.25 in) of the components or traces of the printed circuit assembly.

Battery connections

1. Using a D122 Dual Battery Harness, connect two 12 V 7 Ah batteries in the control panel enclosure.

- Use a separate D8108A for the two 12 V 7 Ah batteries. When using a D122L Dual Battery Harness, wire the batteries in parallel and connect the harness to the BAT+ and BAT- terminals of the control panel.

Bell requirements

Use the following Rothenbuhler bell and balanced line modules with the control panel:

- UL Listed Model 5110 Bell
- UL Listed Model 4001-42 External Line Balancer

Rothenbuhler 5110/4001-42 High Security Bell overview

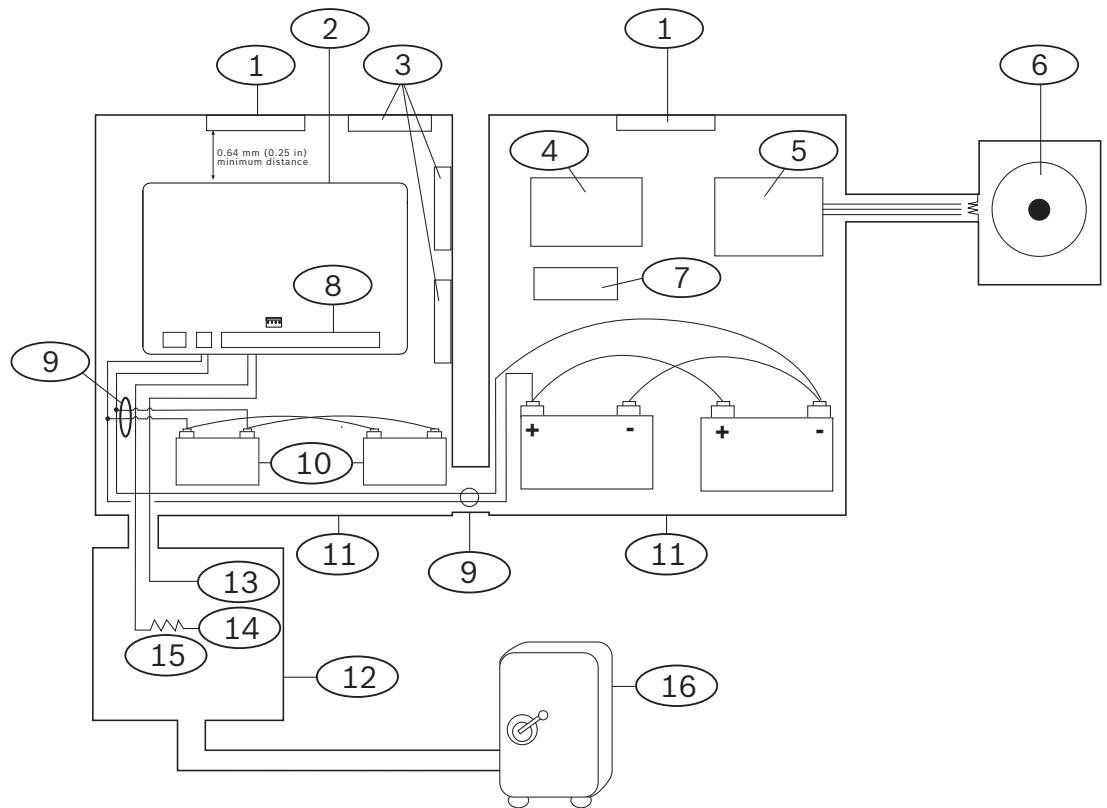

Callout — Description	Callout — Description
1 — Self-contained UL listed vibration sensor	9 — D122/D122L ²
2 — Control panel	10 — D126 battery
3 — Accessory modules	11 — D8108A enclosure
4 — High line security module	12 — Proximity/control unit
5 — 4001-42 Balanced Line Module	13 — Normally open (NO)
6 — 5110 Bell	14 — Normally closed (NC)
7 — D133 Relay	15 — End-of-line (EOL) resistor
8 — Alarm input point ¹	16 — Safe
¹ Use Terminals 1 through 8. (Select only one.)	
² Use a D113 Battery Lead Supervision Module to supervise the battery connections.	

Rothenbuhler 5110/4001-42 High Security Bell to control panel wiring

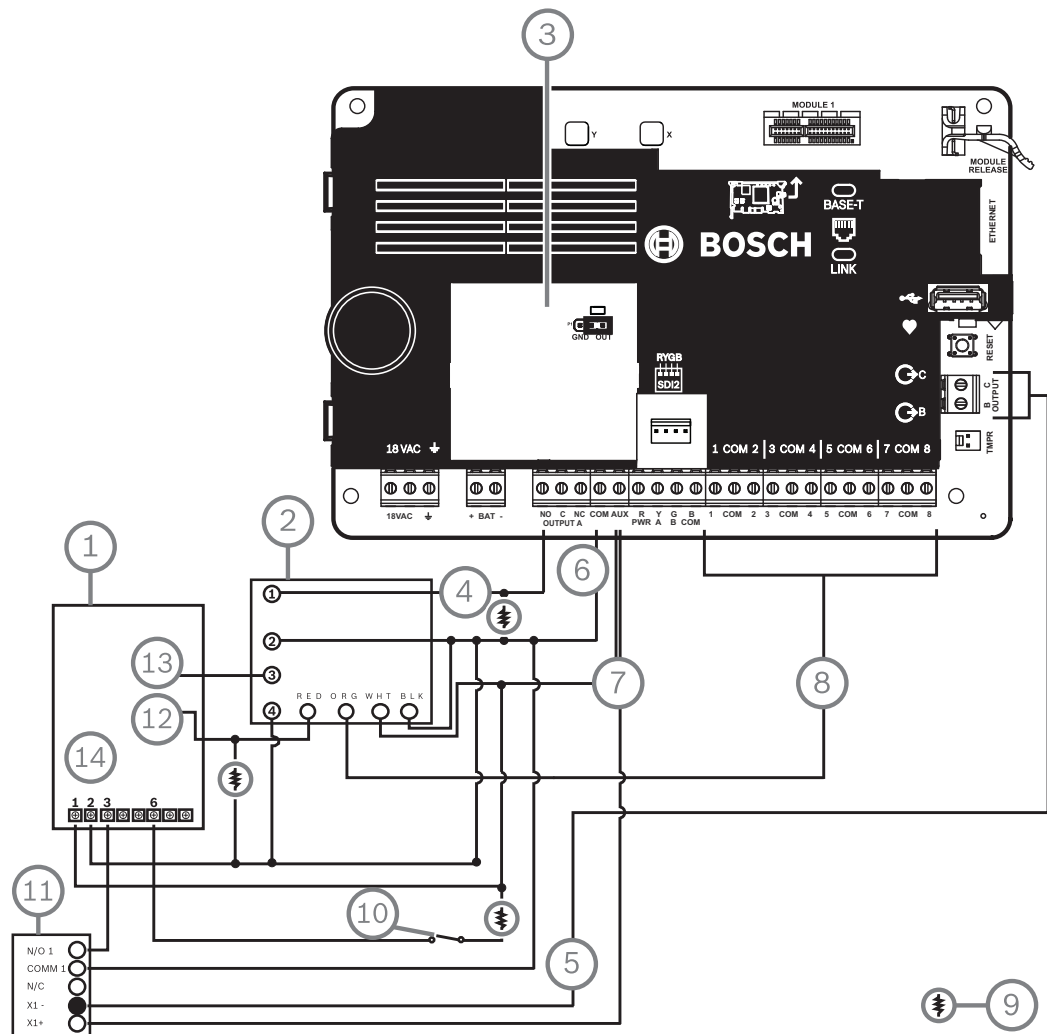

Figure 19.1: Detailed Rothenbuhler 5110_4001-42 High Security Bell to control panel wiring (B5512 shown)

Callout — Description	Callout — Description
1 — 5110 Logic Board	8 — Alarm input point*
2 — 4001-42 External Line Balancing Module	9 — 10 kΩ resistor
3 — Control panel set to OUTPUT A using AUX PWR	10 — Optional silence switch
4 — Alarm output	11 — D133 Relay Module
5 — Alternate alarm (use B or C)	12 — BBL In 4
6 — Common	13 — BBL Out 5
7 — +12.0 VDC	14 — Terminal TB1

*Use Terminals 1 through 8. (Select only one.)

**Notice!****Bell Test at Arming**

UL Standard 365 requires a Bell Test at arming for bank safe and vault applications.

The Bell Test feature only works when the area is armed All On. The Bell Test feature does not work when the area is armed Part On.

System configuration requirements

The following configuration and programming options are required for UL Bank Safe and Vault Systems. Refer to RPS Help, the Installer Services Portal programming tool (available in Europe, Middle East, Africa, and China) Help, or the control panel's Program Entry Guide for programming information.

Safe and Vault protective circuits

To test the devices that protect the safe(s) or vault(s) without sounding the bell, specify the devices' points as controlled zones and supervised for trouble conditions. Refer to Point Profile in RPS Help, in the Installer Services Portal programming tool (available in Europe, Middle East, Africa, and China) Help or in the control panel's Program Entry Guide for more information.

Bell configuration

1. UL 365 requires a bell time of 15 to 30 min. The Rothenbuhler 5110 Bell provides selectable bell time through manipulation of its jumpers. Refer to the manufacturer's installation instructions for more information.
2. In addition to the jumper settings inside the bell, you can activate the control panel for a bell time of 15 min.
3. UL 365 requires a Bell Test at arming and you must enable it in control panel programming.
4. Refer to the various bell parameters in RPS Help, in the Installer Services Portal programming tool (available in Europe, Middle East, Africa, and China) Help or in or the control panel's Program Entry Guide for more bell time and test programming information.

Bell test**Notice!**

Bell Test for All On arming only

The Bell Test feature only works when the area is armed All On. The Bell Test feature does not work when the area is armed Part On.

1. To enable the bell test feature, you enable an unused area of the control panel. Enable the bell test feature for the unused area only. Program OUTPUT B as the area bell output for the unused area.
2. Make all passcodes with authority to arm the safe or vault and also send a Closing Report valid in this area. Program the area for a five-second exit delay.
3. To complete the installation for this feature, connect the output to a D134 Dual Relay Module.

Exit delay

Do not program the control panel's maximum exit delay longer than 30 seconds.

Refer to

- *Rothenbuhler 5110/4001-42 High Security Bell overview, page 85*

19.1.3 Fire applications

You can use UL Listed fire initiating devices not requiring electrical compatibility evaluation in any application. For example, the four-wire smoke detectors, heat detectors, waterflow switches, and manual pull stations are suitable fire initiating devices. Consult the individual component specification and installation documents to determine suitability.

**Notice!**

UL requires that the control panel supervises any device powered from a power output.

**Notice!**

The control panel does not support multiple detectors in alarm. The control panel is compatible with detectors with optional features. Do not mix detectors from different manufacturers on the same circuit.

**Notice!**

UL 985 requirements for Household Fire Warning System Units

To comply with UL 985 requirements for Household Fire Warning System Units, configure the fire alarm silence to require a passcode.

**Notice!**

UL 985 requirements for Household Fire Warning System Units

In Household combination systems, Burglar and Fire, non-fire devices are required to be connected to a separate limited power supply such non-fire devices shall not impede or impair the fire system.

**Notice!**

UL 985 requirements for Household Fire Warning System Units

For Household Fire Warning System Units, the panel is required to have an audible sound when there is no keypad attached.

To meet this requirement, there are two options:

1. Add a second keypad that is home run. For correct home run wiring of a keypad, refer to the figure in SDI2 bus wiring recommendations, callout no. 5. Do **not** use a daisy chain wiring (callout no. 3).
Or:
2. For system units with software version 3.10 or higher, use output B or C of the B Series panel to connect a piezo (see specification below for the piezo) configured to pulse when a system trouble occurs.

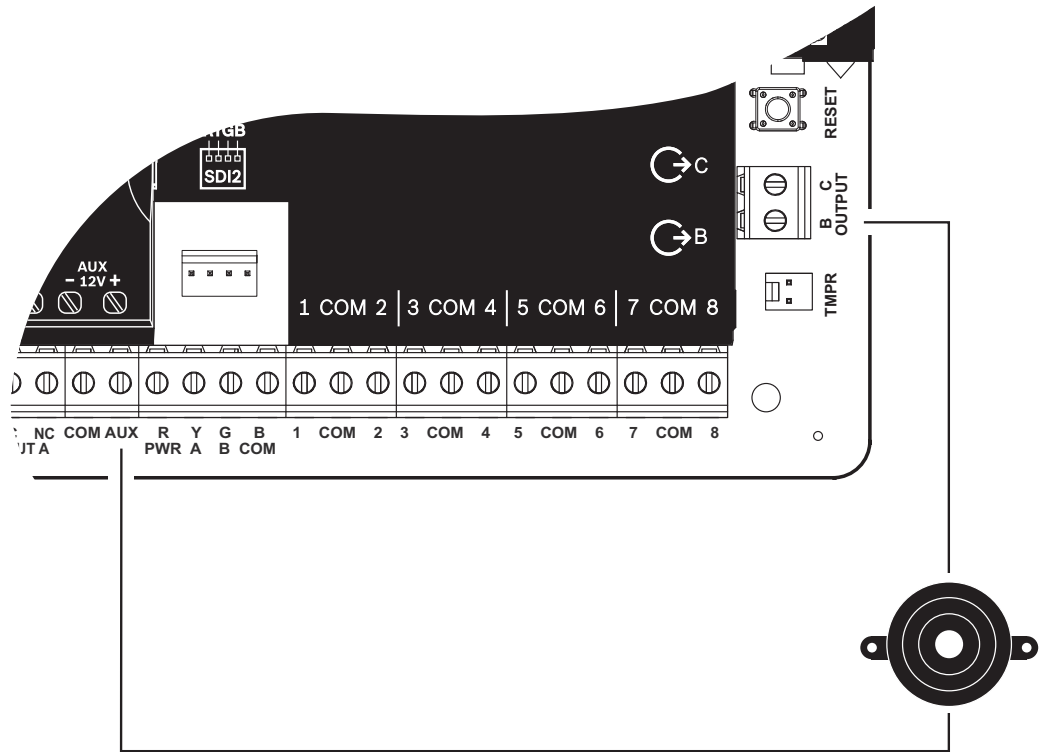

Figure 19.2: Piezo connected to output B and +12V
Piezo specifications:

Operating Voltage	9V DC to 15V
Maximum DC Current at Rated Voltage	50 mA
DC Resonant Frequency	3 KHz +/-1Khz
Sound Output at 10cm, at rated voltage	>90dB @ 10V
DC Operating Temperature	0°C to +50°C
Housing Material	UL94 HB or better
Lead Wires	22 AWG

Four-wire smoke detectors

When using four-wire smoke detectors, install a power supervision device according to the manufacturer’s instructions. You can connect any number of four-wire smoke detectors to the control panel (subject to available auxiliary power).

The Reset Sensor command is available from the keypads when the Reset Sensor is enabled. Connect the smoke detectors to a suitable interface such as the B208 Octo-input Module or on-board point to meet UL and NFPA requirements.

Notification Appliance Circuit (NAC)

Refer to *Notification appliance circuit wiring, page 79.*



Notice!

Test weekly

Perform a fire test once each week.

Class “B” circuit

Loops A and B on the D125B Module are Class “B” initiating circuits suitable for connecting any fire alarm initiating device, including two-wire and four-wire smoke detectors.

Connecting initiating devices to on-board points (1 through 8) on the control panel.

- Use a D125B Powered Loop Interface Module with two-wire initiating devices.
- Use a D129 Dual Class “A” Initiating Circuit Module with any type of initiating device, except a two-wire smoke detector.

Connecting initiating devices to off-board points:

- Do not connect two-wire smoke detectors to POPITs or MUX bus inputs.
- Use the D9127U or D9127T POPIT Modules to connect four-wire smoke.

Other devices

Use a D130 Relay Module, D8129 OctoRelay, or Switched Aux (Terminal 8) to provide reset capability to other initiating devices such as:

- B308 Octo-output Module
- D125B Powered Loop Interface Module (2-wire smoke detector module)
- D129 Dual “Class A” Initiation Circuit Module (4-wire smoke detector)
- D9127T/U POPITs
- On-board points

Install devices according to the manufacturer’s instructions. For more information, refer to *Off-board outputs, page 51*.

For battery calculations, refer to *Standby battery requirements and calculations, page 93*.

**Notice!****Test weekly**

Perform a fire test once each week.

19.1.4**Enclosures**

Mount the control panel assembly in any of the Bosch Security Systems, Inc. enclosures listed:

- B10 Medium Control Panel Enclosure
- B11 Small Control Panel Enclosure
- D2203 Enclosure
- B8103 Universal Enclosure*/D8103 Universal Enclosure*
- D8109 Fire Enclosure (red)*
- D8108A Attack Resistant Enclosure*

*Requires a B12 mounting bracket.

B10, B11, D2203, and D8103 enclosures

The B10, B11, D2203, and D8103 enclosures are suitable for residential fire and burglary installations and commercial burglary applications that do not require attack resistance or the approval by Factory Mutual (FM) or New York City – Materials and Equipment Acceptance (NYC-MEA). Refer to *Compatible UL listed components, page 91* for acceptable applications.

D8108A Enclosure

The D8108A is attack resistant and intended primarily for UL commercial burglar alarm and mercantile safe and vault applications requiring a local bell. Use this enclosure in any burglar or fire alarm application where the D8109 Enclosure is suitable.

With some modification, you can use the D8108A for bank safe and vault applications. UL lists the D8108A for all commercial fire alarm applications. It is approved by FM, CSFM, and the NYC-MEA.

D8109 Red Fire Enclosure

Generally, the D8109 is used for fire alarm applications. It is approved by FM, CSFM, and the NYC-MEA.

B12 Mounting Plate for D8103 Enclosure

The mounting plate is compatible with the D8103, D8108A, and D8109 Enclosures.

19.2 Combination fire and intrusion alarm systems

A system can include a combination of fire and intrusion devices on any bus or module.

**Notice!**

If using Output Profiles within UL985 installations, do not use “Timed” as the duration for Fire or Gas triggers for the primary notification appliance (siren).

19.3 Compatible UL listed components

	Household Burglary	Household Fire	Household Fire/ Burglary Combined	Central Station Burglary/ Proprietary	Police Connected Burglary	Local Burglary	Holdup
Minimum Hours of Standby Battery	4	24 + 4 min alarm		4	4	4	8
B10 Medium Control Panel Enclosure	Opt.	Opt.	Opt.	Opt.	Opt.	Opt.	Opt.
B11 Small Control Panel Enclosure	Opt.	Opt.	Opt.	Opt.	Opt.	Opt.	Opt.
B201 2-wire Powered Loop Module	Opt.	Opt.	Opt.	Opt.	Opt.	Opt.	Opt.
B208 Octo-input Module	Opt.	Opt.	Opt.	Opt.	Opt.	Opt.	Opt.
B308 Octo-output Module	Opt.	Opt.	Opt.	Opt.	Opt.	Opt.	Opt.
B426 Conettix Ethernet Communication Module	Opt.	Opt.	Opt.	Opt.	Opt.	Opt.	Opt.
B430 Plug-in Telephone Communicator	Opt.	Opt.	Opt.	Opt.	Opt.	Opt.	Opt.
B442 Conettix Plug-in Cellular Communicator ²	Opt.	No	No	Opt.	Opt.	Opt.	Opt.
B443 Conettix Plug-in Cellular Communicator ²	Opt.	Opt.	Opt.	Opt.	Opt.	Opt.	Opt.
B444-A Plug-in cell module, AT&T LTE	Opt.	Opt.	Opt.	Opt.	Opt.	Opt.	Opt.
B444-V Plug-in cell module, Verizon LTE	Opt.	Opt.	Opt.	Opt.	Opt.	Opt.	Opt.

B450 Conettix Plug-in Communicator Interface	Opt.	Opt.	Opt.	Opt.	Opt.	Opt.	Opt.
B520 Auxiliary Power Supply Module	Opt.	Opt.	Opt.	Opt.	Opt.	Opt.	Opt.
B810 RADION receiver SD	Opt.	Opt.	Opt.	Opt.	Opt.	Opt.	Opt.
B820 SDI2 Inovonics Interface Module	Opt.	Opt.	Opt.	Opt.	Opt.	Opt.	Opt.
B901 Access Control Module ³	Opt.	Opt.	Opt.	Opt.	Opt.	Opt.	Opt.
B915/B915I Basic Keypad	1+	1+	1+	1+	1+	1+	Opt.
B920 Two-line Alphanumeric Keypad (SDI2)	1+	1+	1+	1+	1+	1+	Opt.
B921C Two-line Capacitive Keypad	1+	1+	1+	1+	1+	1+	Opt.
B930 keypads	1+	1+	1+	1+	1+	1+	Opt.
B940W Touch screen KP, White	1+	1+	1+	1+	1+	1+	Opt.
B942/B942W Touch Screen Keypad	1+	1+	1+	1+	1+	1+	Opt.
CX4010 Plug-in Transformer (18 VAC 22 VA 60 Hz)	Required for all applications.						Opt.
D125B Dual Class B Initiating Module	Opt.	Opt.	Opt.	Opt.	Opt.	Opt.	Opt.
D126 Standby Battery (12 V, 7 Ah)	Opt.	Opt.	Opt.	Opt.	Opt.	Opt.	Opt.
D130 Auxiliary Relay Module	Opt.	Opt.	Opt.	Opt.	Opt.	Opt.	Opt.
D133 Single Relay Module	Opt.	Opt.	Opt.	Opt.	Opt.	Opt.	Opt.
D134 Dual Relay Module	Opt.	Opt.	Opt.	Opt.	Opt.	Opt.	Opt.
D1218 Battery (12 V, 18 Ah)	Opt.	Opt.	Opt.	Opt.	Opt.	Opt.	Opt.
D192G Class “B”, Bell Circuit Supervision	Opt.	Req.	Opt.	Opt.	Opt.	Opt.	Opt.
D8004 Transformer Enclosure	Opt.	Opt.	Opt.	Opt.	Opt.	Opt.	Opt.
D8108A Attack Resistant Enclosure or D8109 Fire Enclosure	Opt.	Opt.	Opt.	Opt.	No	Opt.	Opt.
D8108A Attack Resistant Enclosure ¹	Opt.	Opt.	Opt.	Opt.	Opt.	Opt.	Opt.

Key

No	Not acceptable for this application.
Req.	Required for this application.
Opt .	Optional for this application.
1+	1 or more required for this application. Consult the appropriate standard.

¹For commercial applications using the B430, and when doing local or police station connect applications, the D8108A Enclosure is required for all applications.

²Check for availability in your region.

³B6512 only.

19.4 Standby battery requirements and calculations

Standby battery calculations

UL 365 requires 72 hours of standby battery capacity. Limit the auxiliary power current for all devices, including keypads, to 80 mA or less to meet this requirement.

		A			B			C		
		AC Power On Normal Current (mA)			AC Power Off Minimum Current (mA)			In Alarm Maximum Current (mA)		
Model Number	Qty Used	Each Unit	Qty	Total	Each Unit	Qty	Total	Each Unit	Qty	Total
B6512/B5512/ B4512/B3512	_____	125	x1	=125	125	x1	=125	155	x1	=155
B201	_____	18	xQty	=_____	18	xQty	=_____	35	xQty	=_____
B208	_____	35	xQty	=_____	35	xQty	=_____	35	xQty	=_____
B308	_____	22 ¹	xQty	=_____	22 ¹	xQty	=_____	22 ²	xQty	=_____
B426	_____	100	xQty	=_____	100	xQty	=_____	100	xQty	=_____
B430	_____	5	x1	=_____	5	xQty	=_____	25	x1	=_____
B442	_____	35	x1	=_____	35	x1	=35	150	x1	=_____
B443	_____	35	x1	=_____	35	x1	=35	150	x1	=_____
B444-A	_____	40	x1	=_____	35	x1	=35	150	x1	=_____
B444-V	_____	40	x1	=_____	35	x1	=35	150	x1	=_____
B450 ³	_____	30	xQty	=_____	30	xQty	=_____	30	xQty	=_____
B520	_____	15	xQty	=_____	15	xQty	=_____	15	xQty	=_____
B810	_____	100	xQty	=_____	100	xQty	=_____	100	xQty	=_____
B820	_____	100	xQty	=_____	100	xQty	=_____	100	xQty	=_____
B901 ⁶	_____	110	xQty	=_____	110	xQty	=_____	110	xQty	=_____
B915/B915I	_____	35	xQty	=_____	35	xQty	=_____	70	xQty	=_____
B920	_____	35	xQty	=_____	35	xQty	=_____	70	xQty	=_____
B921C	_____	45	xQty	=_____	45	xQty	=_____	85	xQty	=_____
B930	_____	35	xQty	=_____	35	xQty	=_____	80	xQty	=_____

B940W	_____	250	xQty = _____	230	xQty = _____	365	xQty = _____
B942/B942W ⁴	_____	200	xQty = _____	200	xQty = _____	300	xQty = _____
D125B	_____	25	xQty = _____	25	xQty = _____	168	xQty = _____
D129	_____	23	xQty = _____	23	xQty = _____	25	xQty = _____
D132A	_____	10	xQty = _____	10	xQty = _____	70	xQty = _____
D133 ⁵	_____		xQty = _____		xQty = _____		xQty = _____
D134 ⁵	_____		xQty = _____		xQty = _____		xQty = _____
D192G	_____	35	xQty = _____	35	xQty = _____	100	xQty = _____
Ratings of other devices in the system that are not shown above:							
___	_____	___	xQty = _____	___	xQty = _____	___	xQty = _____
___	_____	___	xQty = _____	___	xQty = _____	___	xQty = _____
___	_____	___	xQty = _____	___	xQty = _____	___	xQty = _____
___	_____	___	xQty = _____	___	xQty = _____	___	xQty = _____
			Total A= _____		Total B= _____		Total C= _____
<p>¹ The Standby calculation for the module is: 22 xQty + (16.25 x number of relays active in standby).</p> <p>² The In Alarm calculation for the module is: 22 xQty + (16.25 x number of relays active in alarm).</p> <p>³ Currents listed are for the B450 only. Include plug-in device currents in calculations.</p> <p>⁴ If using the proximity reader, add 100 mA to columns A, B, and C before calculating.</p> <p>⁵ 40 mA for each active relay.</p> <p>⁶ Use 110 mA + reader. Do not exceed 260 mA.</p>							

Table 19.10: Current rating chart for standby battery calculations

Application	Standby time (in hours) minimum	Alarm time (in minutes) minimum	Calculations ²
Household Burglary	4	4	
Proprietary Burglary	4	N/A	
Central Station (Bank)	72 ¹	N/A	
Central Station (Mercantile)	4	N/A	
Police Station Connected (Bank)	72 ¹	30 (CUL)/15 (UL)	
Police Station Connected (Mercantile)	24	30 (CUL)/15 (UL)	
Local Burglary (Bank)	72 ¹	30 (CUL)/15 (UL)	
Local Burglary (Mercantile)	24	30 (CUL)/15 (UL)	
Holdup	8	N/A	
Household Fire	24	5 (CUL)/4 (UL)	
Household Fire with Wireless CO	24	4 + 4 (UL)	

¹ UL 365: Auxiliary power current for all devices, including keypads, must be limited to 80 mA or less to meet this requirement.
² For values of Total B and Total C, refer to *Standby battery calculations, page 93*.

Table 19.11: Minimum standby and alarm times

Total B		Hours		Total C		Alarm Operation		Contingency		Total Ah
((_____	x	standby time)	+	(_____	x	Alarm time/60))	x	1.25	=	_____

Tab. 19.12: Values of Total B and Total C

Total Ah requirements must not exceed the Ah capacity of batteries:

- One D126 Battery=7 Ah
- Two D126 Batteries=14 Ah
- One D1218 Battery=18 Ah



Notice!

Because of changing regulations, verify the necessary time with your local authority having jurisdiction (AHJ).



Notice!

UL 985 requirements for Household Fire Warning System Units
 A minimum of 12 hours of carbon monoxide audible alarm is achieved through the wireless self-powered detector.

19.4.1 Household Fire Warning equipment

The Household Fire Warning Equipment Standard requires 24 hours of standby current plus 4 minutes of alarm operation at the end of the 24-hour period. Use battery Ah calculations to confirm compliance. The formula shown below includes the calculation for 4 minutes of alarm operation at the end of the 24-hour period, and a 15% contingency factor that allows for depletion of battery capacity with age.

Total B ¹		Hours		Total C ¹		Alarm Operation ²		Contingency		Total Ah ³
(_____	x	24)	+	(_____	x	0.083)	+	15%	=	_____

¹ Refer to previous table.
² Value = Minutes of alarm operation/60
³ Total Ah requirements must not exceed the Ah capacity of batteries:
 - One D126 Battery = 7 Ah
 - Two D126 Batteries = 14 Ah
 - One D1218 Battery = 17.2 or 18 Ah

Table 19.13: Household fire ampere-hour (Ah) calculation formula

19.5 UL 365 - Police Station Connected Burglar Alarm Units and Systems

In a mercantile burglar alarm system, a mercantile alarm sounding device located within a building but outside the protected area is acceptable provided it is rated for outside service and alarm conditions are transmitted to:

- The dispatch location of the law enforcement agency having jurisdiction over the protected property
- or
- A central station or residential monitoring station complying with the Standard for Central-Station Alarm Services, UL 827.

In a mercantile burglar alarm system, an alarm sounding device located within the area of greatest protection, or outside the area of greatest protection but within an area protected by an alarm system, and that shares a common control unit with the system installed in the area of greatest protection, is acceptable provided it is rated for inside service and alarm conditions are transmitted to:

- The dispatch location of the law enforcement agency having jurisdiction over the protected property
- or
- A central station or residential monitoring station complying with the Standard for Central-Station Alarm Services, UL 827.

Mount an inside sounding device at least 10 feet (3.05 m) above the floor or at the surface of the ceiling. When fixed construction within the area could provide access for an intruder, the mount the alarm sounding device at least 4 ft (1.2 m) as measured horizontally, away from the edges of the fixed construction or at least 10 ft (3.05 m) above it so as to minimize access by an intruder.

19.6 UL 636 - Holdup Alarm Units and System

When using the system for hold-up operation, a hold-up point should be assigned to a point as follows:

- P## Point Type set to 24-hr, P## Point Response set to 0 (Point is constantly armed regardless of the status of the system.)
- P## Invisible Point set to Yes (Keypads do not display alarm activity from this point.)

When using the Conettix Modem4 format, the unique point text should be set to “Hold-Up”, or equivalent language per the AHJ.

When using the Conettix ANSI-SIA Contact ID format, because the Contact ID system doesn’t provide custom text, the hold-up point should be associated as a “hold-up” point at the receiving station. Set Area # Delay Restorals as follows:

- Area # Delay Restorals = No (Restoral report is sent when point restores.)

19.7 Required values to achieve 180s (ULC)/200s (UL) supervision interval

Applicable for both IP and cellular communication.

Requirement	Parameter
Supervision interval for IP and Cellular communication is 200 seconds (UL)	Panel Wide Parameters > Enhanced Communications > Receiver Supervision Time set to 200 seconds
Supervision interval for IP and Cellular communication is 180 seconds (ULC)	Panel Wide Parameters > Enhanced Communications > Receiver Supervision Time set to Custom, Poll Rate set to 89, ACK Wait Time set to 15, and Retry Count set to 5

19.8 ULC

Conduct testing monthly, with the primary de-energized.

20 Keypad Installer menu

In addition to RPS and the Installer Services Portal programming tool (available in Europe, Middle East, Africa, and China), you can configure and diagnose a system with a keypad. Programming and diagnostics options appear on the keypad when you access the **Main Menu (Installer)** option, which includes the Installer menu. The **Main Menu (Installer)** option becomes available during normal control panel operation only when you enter the installer passcode and press **Enter**. The default installer passcode is 1-2-3.

The tools within the **Main Menu (Installer)** are:

- **Programming Menu.** Program several parameters to make your system operational. Options include: phone number and format, enhanced communication options, RPS or Installer Services Portal programming tool parameters, users, points, and keypad parameters. Refer to [1] *Program menu (Programming)*, page 103, and to RPS Help or the Installer Services Portal programming tool Help.
- **Wireless Menu.** Add, replace, remove, and diagnose points and repeaters. Refer to [2] *Wireless menu*, page 123.
- **Diagnostics Menu.** Diagnose points, repeaters, cellular service, IP cameras, and Cloud. Refer to [3] *Diags menu*, page 125.
- **Service Bypass Menu.** View whether points are removed from service. Refer to [4] *Service Bypass (Serv Byp) menu*, page 127.
- **Version Menu.** View the version information for the control panel, encryption, and more. Refer to [5] *Versions menu*, page 127.
- **Cloud Menu.** Enable Cloud connectivity for the control panel. Refer to [6] *Cloud menu*, page 128.

Installer keypads and SERVICE MODE

The Installer menu is also available from the Service menu when in SERVICE MODE. The Service menu is a subset of the Main menu (Installer) option. You can use Service mode at any keypad, but the feature is most useful when you want to directly connect an Installer keypad to the control panel for keypad programming at the control panel.

Accessing SERVICE MODE (rapid pulsing Heartbeat LED)

1. Set the Installer keypad to address 0.
2. Connect it to the control panel.
3. Press and hold the control panel RESET button until the Heartbeat LED flashes fast. The keypad shows SERVICE MODE and prompts for the installer passcode.
4. Enter your installer passcode and press **Enter**.

Exiting SERVICE MODE and returning to normal operation (slow pulsing Heartbeat LED)

- ▶ Press and hold the control panel RESET button for approximately 5 seconds until the Heartbeat LED turns off.
- ✓ The control panel resets.

Conventions for this section

This guide to the keypad Installer menu provides instructions for using the keypad, based on the following conventions:

- This section covers all compatible keypads. It provides specific steps for each keypad style, when applicable.
- All instructions access the Installer menu from the **Main Menu (Installer)** option, not while in SERVICE MODE.

- For simplicity, the keypad Installer menu tree and instructions combine the two-line keypad number selections with the text and graphic steps of other keypads. For example, this section does not have the B920 instructions of Press [2] for enhanced comm parameters, and for the B930 instructions of Press [2] **Enhanced Comm Parm.** It has the following more general instructions for all keypads: Press [2] **Enhanced Comm Parm.**
- Go to [1] **Programming Menu** > [1] **Reporting** > [2] **Network** > [2] **Enhanced Comm Parm.**

Installer menu tree

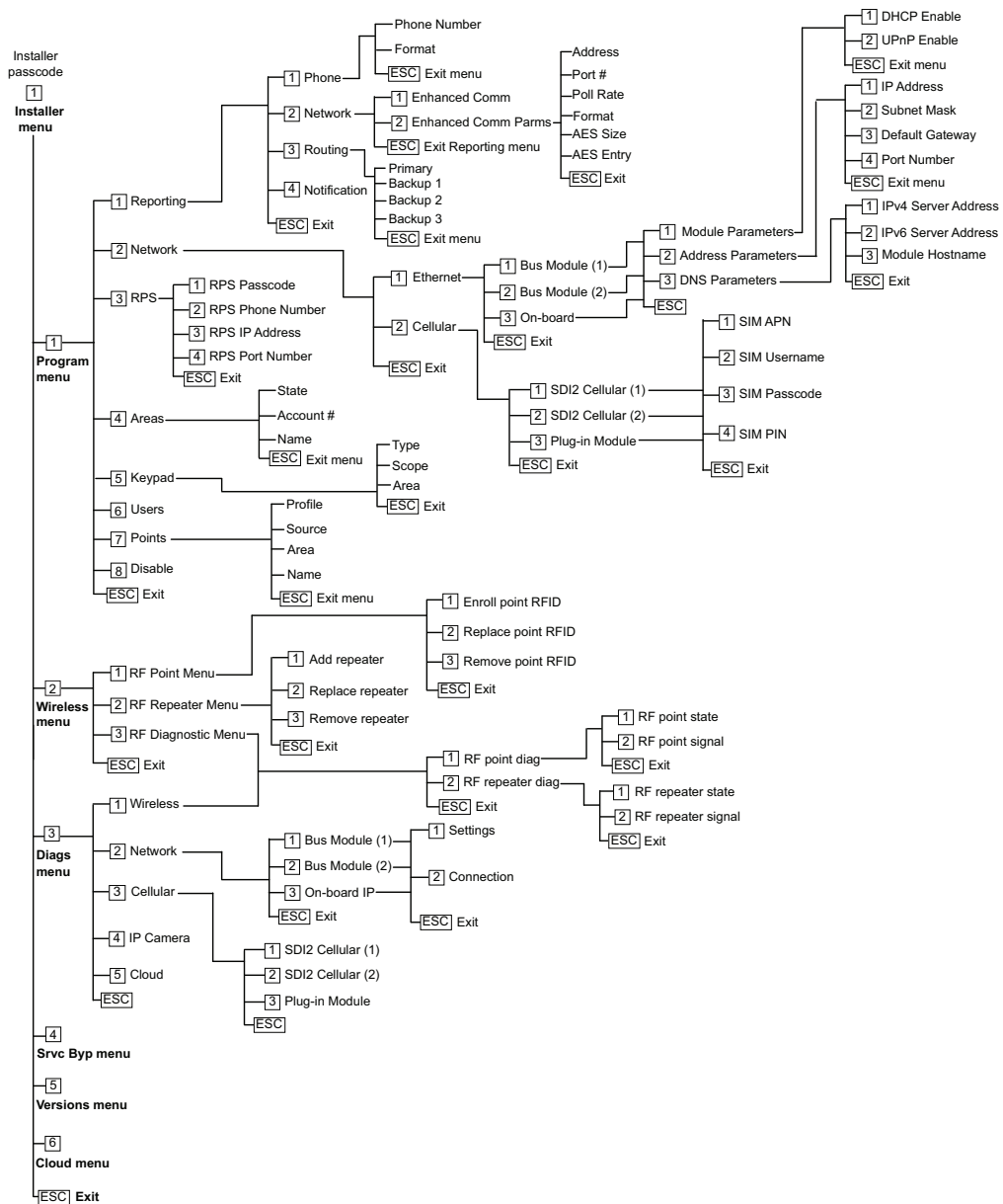

User menu trees

Menu tree

The following graphics show the menu tree for the B94x / B93x keypads.

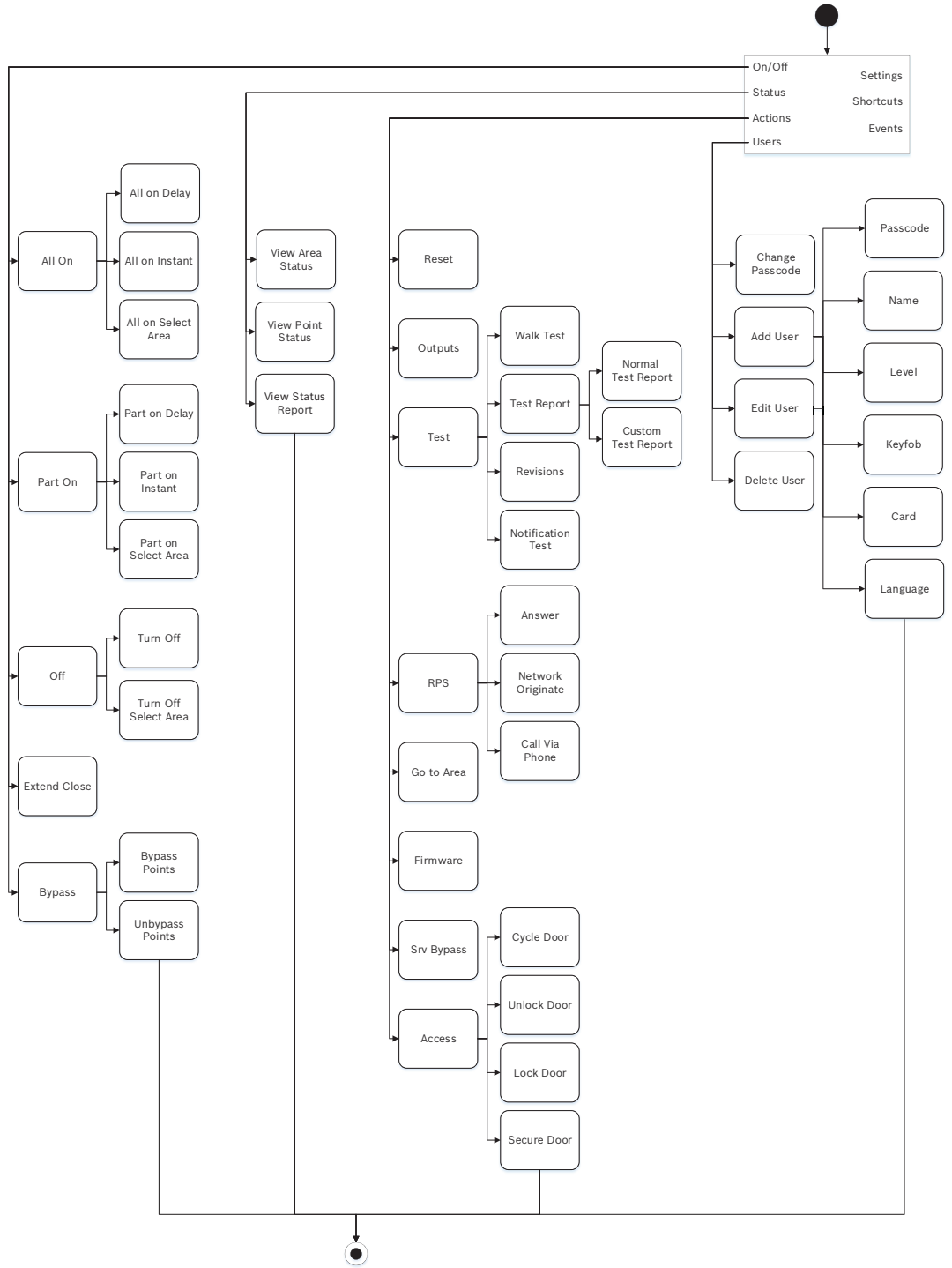

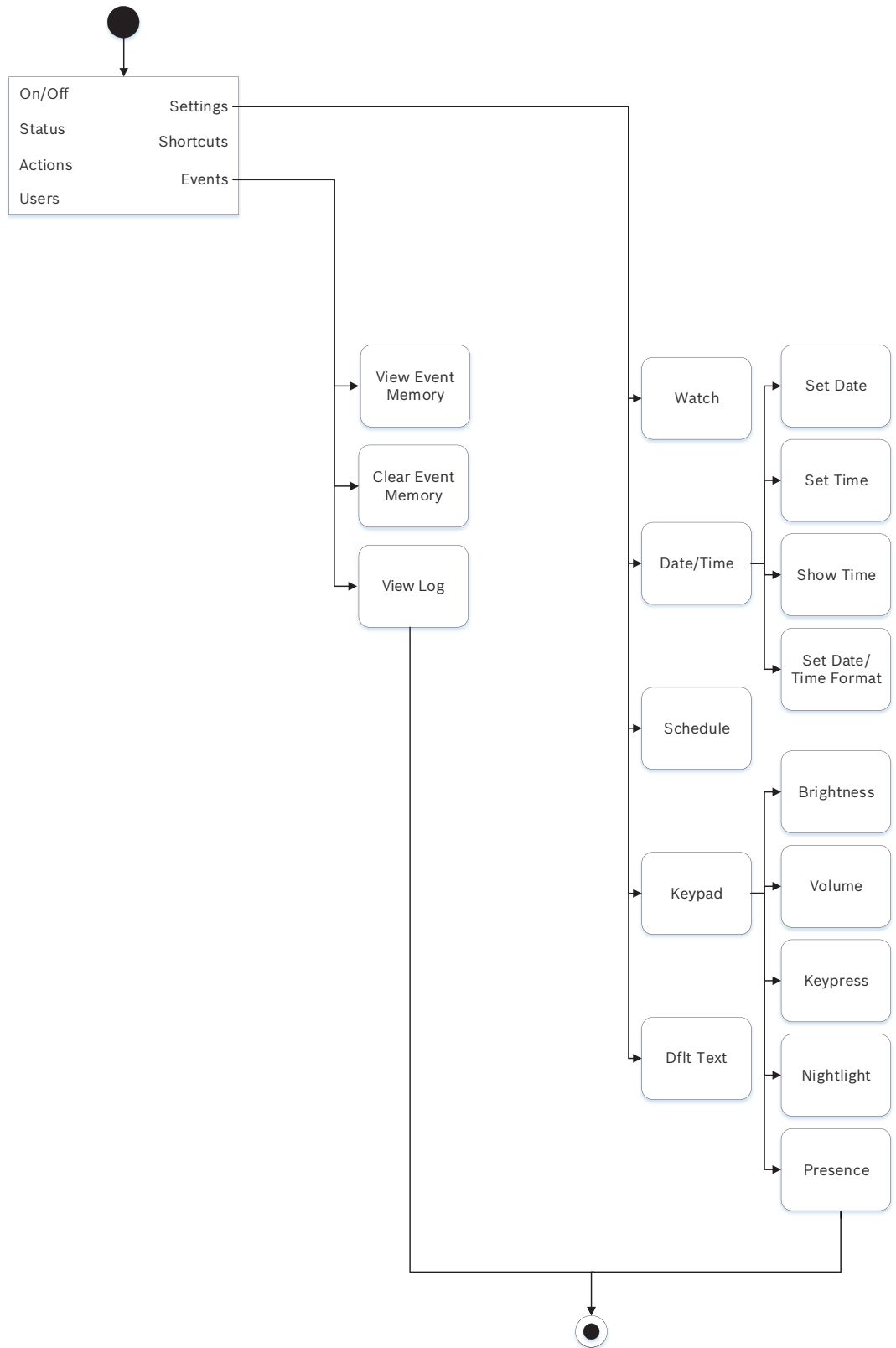



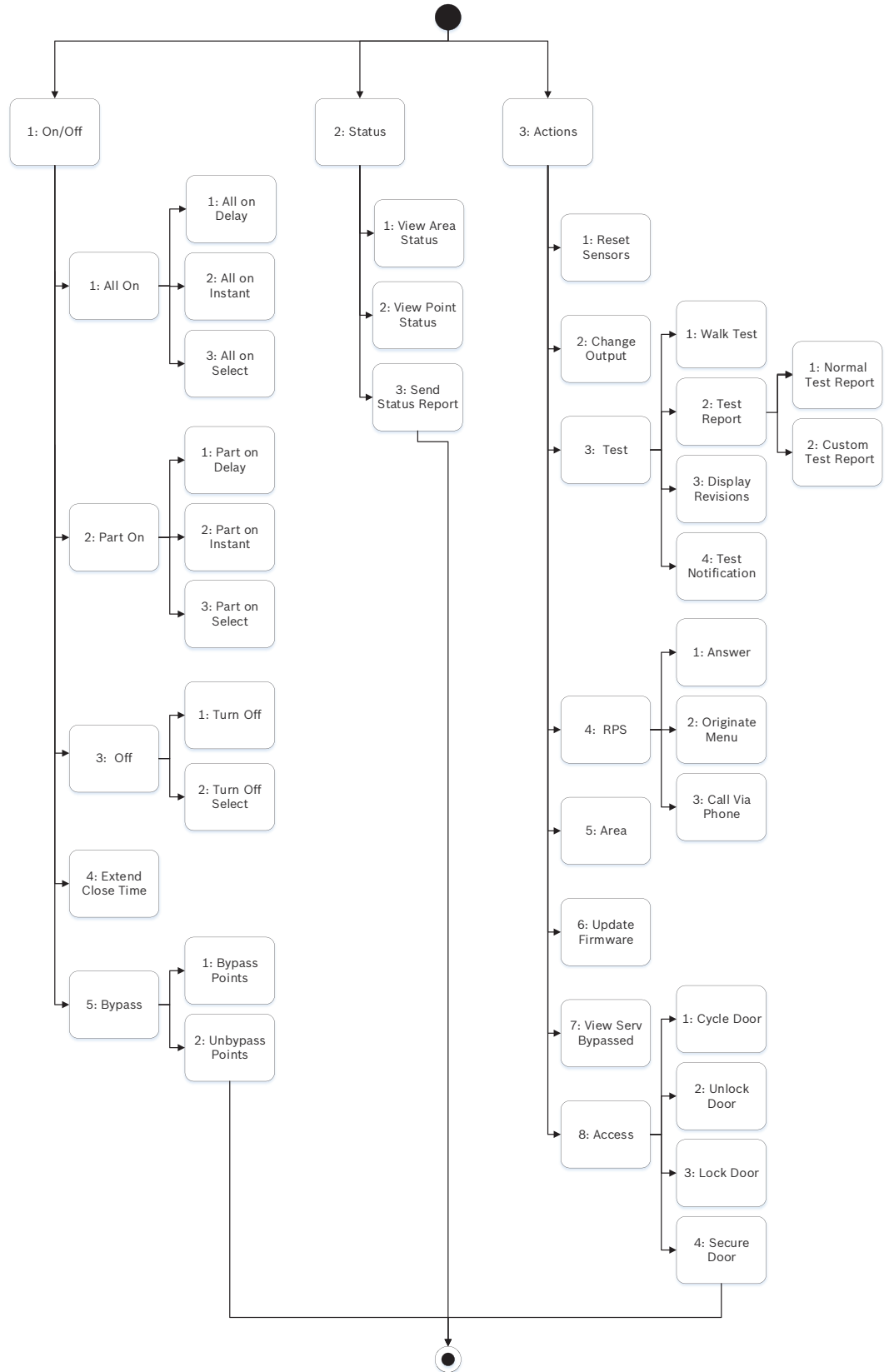

Menu tree

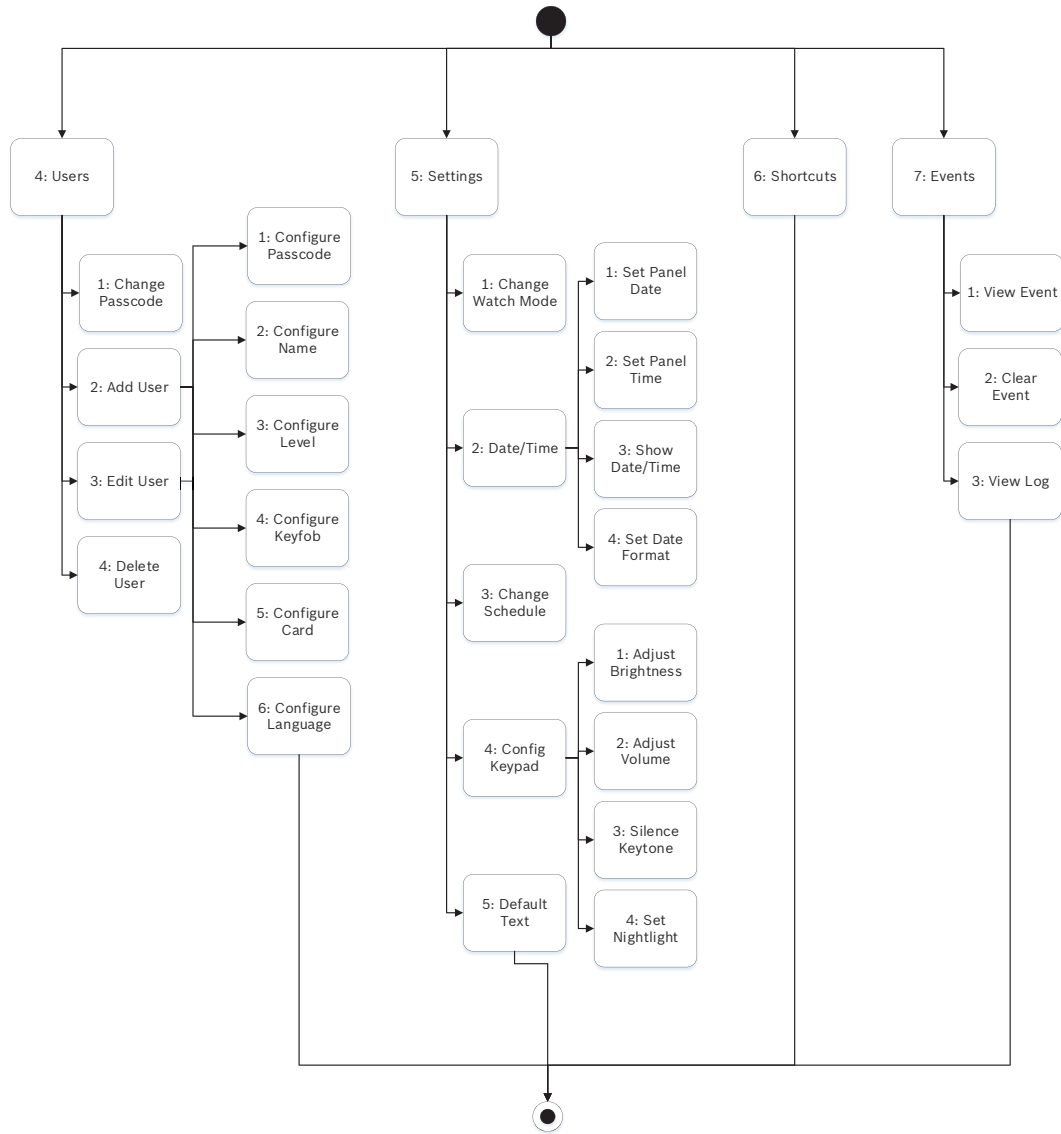

The following graphics show the menu tree for the B92x / B91x keypads.







Escape, delete characters, and enter letters and special characters

- Escape from a menu. B91x*/B92x/B93x keypads include a hard [ESC] key. To exit a menu and return to the previous level, press [ESC]. To exit and return to idle text from any level of the menu structure, press and hold [ESC]. The B94x has a  key. To exit a menu and return to the previous level, press . Notice! If editing a value on the B91x/B92x/B93x keypads, press and hold [ESC] to delete all the characters.
- Delete characters. B91x/B92x/B93x keypads use the [ESC] key as a backspace key. Press it once to delete the last character, or press and hold [ESC] to delete all the characters. The B94x key has a  (backspace) key on each keyboard screen.
- Enter letters. For B91x/B92x/B93x keypads, press a number key repeatedly to scroll through the number and letters shown on the key. For B94x, use the ABC keyboard.
- Save. B91x/B92x keypads typically use **Enter** to save. The B93x/B94x keypads typically use **Save** to save. The B94x keypad uses the  key to save from the Qwerty keyboard.

- Special characters. For entering special characters on B91x/B92x keypads, refer to the following table. For entering special characters on a B93x, use the corresponding softkey. For entering special characters or accented characters on a B94x, press  or  to open the corresponding keyboard.

Characters	B91x/B92x
Special dialing characters in phone numbers (*, C [3-sec pause], D [Dial Tone Detect])	Press [CMD]. The special characters menu appears. Use  /Previous or  /Next to cycle through the characters. Press Enter to choose the character shown.
Network address characters	Use the [0] key to enter a period or dash.

***B915I keys**

The B915I keypad uses the following icons, instead of words, on hard keys. All instructions in this section refer to the word key without specifying the B915I icon.

B915 key	BB915I key
[PREV]	[▲]
[ENTER]	[-]
[NEXT]	[▼]
[ESC]	[*]
[CMD]	[#]

Refer to

- [3] Diags menu, page 125
- [6] Cloud menu, page 128
- [1] Program menu (Programming), page 103
- [2] Wireless menu, page 123
- [4] Service Bypass (Serv Byp) menu, page 127
- [5] Versions menu, page 127

20.1 [1] Program menu (Programming)

With the **Program menu (Programming Menu)**, you can program parameters to make your system operational, including phone number and format, enhanced communication options, primary and backup destination devices, and notifications.

20.1.1 [1] Reporting > [1] Phone menu parameters

The control panel can dial as many as four different telephone numbers when sending event reports. In this menu, you can program the telephone numbers and the format.

	Format (circle one)	Phone number
Phone 1	Modem4/Contact ID/ DC-09	_____
Phone 2	Modem4/Contact ID/ DC-09	_____
Phone 3	Modem4/Contact ID/ DC-09	_____

Phone 4 Modem4/Contact ID/ _____
DC-09

Phone Number

1. Enter the installer passcode, and then go the [1] **Installer Menu**.
2. Go to [1] **Programming Menu** > [1] **Reporting** > [1] **Phone**. The keypad shows the phone number and phone format for the phone destination.
3. Use **←/Previous** or **→/Next** to go to the destination you want to edit.
4. Depending on keypad model:
Press **Edit**.
-or-
Press **Enter** to edit the phone destination and then **Enter** to edit the phone number for the selected destination.
5. Delete existing characters, if necessary, and then enter the new phone number.
6. When finished, press **Enter** or **Save** to save the phone number. The keypad shows **Parameter saved**.
7. Escape from the menu.

Phone Format

1. Enter the installer passcode, and then go the [1] **Installer Menu**.
2. Go to [1] **Programming Menu** > [1] **Reporting** > [1] **Phone**. The keypad shows the phone number and phone format for the phone destination.
3. Use **←/Previous** or **→/Next** to go to the destination you want to edit.
4. Depending on keypad model:
Press **Enter** to edit the phone destination, and then press **Next** to go to the format option, and then press **Enter** to edit the phone format for the selected destination.
5. Press **Format** and then **Edit**. Use **←/Previous** or **→/Next** to toggle between the **Contact ID** and **Modem4** option, and press **Format** while viewing the desired format to select it and save the programming. The keypad shows **Parameter saved**.
6. Escape from the menu.

20.1.2

[1] Reporting > [2] Network menu parameters

Enhanced communications is the ability to communicate by some means other than a standard digital dialer. The control panel can include four separate enhanced communication destinations to which the control panel can route events. In this menu, you can enable enhanced communication and edit the network address, network address, poll rate, and port number for each destination (D1, D2, D3, and D4).

D1	Network address _____	Poll rate _____	Port number _____
D2	Network address _____	Poll rate _____	Port number _____
D3	Network address _____	Poll rate _____	Port number _____
D4	Network address _____	Poll rate _____	Port number _____

Enhanced Comm

1. Enter the installer passcode, and then open the [1] **Installer Menu**.
2. Go to [1] **Programming Menu** > [1] **Reporting** > [2] **Network** > [1] **Enhanced Comm**. The keypad shows the **Enhanced Comm** option as well as the current default value.

3. Depending on keypad model:
Press **Enter** and then press **Disable** or **Enable**.
-or-
Press **Enter**.
Press **Save** or **Enter**. The keypad shows **Parameter saved**.
4. Escape from the menu.

Network Address





Port Number

Poll Rate (seconds)

Format

AES Size

AES Entry

1. Enter the installer passcode, and then open the [1] **Installer Menu**.
2. Go to [1] **Programming Menu** > [1] **Reporting** > [2] **Network** > [2] **Enhanced Comm Params**. The keypad shows the first destination and its address.
3. Use /Previous or /Next to the destination you want to edit.
4. Depending on keypad model:
Press **Edit**.
-or-
Press **Enter** and **Enter** again.
5. Delete existing characters, if necessary, and then enter the new address.
6. Press **Save** or **Enter**. The keypad shows **Parameter saved**.
7. Depending on keypad model:
Press **Port #** and **Edit**.
-or-
Press **Next** and **Enter** and then **Enter**.
8. Delete existing characters, if necessary, and then enter the new number.
9. Press **Save** or **Enter**. The keypad shows **Parameter saved**.
10. Depending on keypad model:
Press **Poll Rate** and **Enter**.
-or-
Press **Next** and **Enter** and then **Enter**.
11. Delete existing characters, if necessary, and then enter the new poll rate.
12. Press **Save** or **Enter**. The keypad shows **Parameter saved**.
13. Depending on keypad model:
Press **Format** and **Edit**.
-or-
Press **Next** and **Enter** and then **Enter**.
14. Press the icon or softkey for the desired option or use /Previous or /Next to select the desired format, **Modem4** or **Contact ID**.
15. Press **Save** or **Enter**. The keypad shows **Parameter saved**.
16. Depending on keypad model:
Press **AES Size** and **Edit**.
-or-

Press **Next** and **Enter** and then **Enter**.

17. Press the softkey for the desired option or use **←/Previous** or **→/Next** to select the desired size.
18. Press **Save** or **Enter**. The keypad shows **Parameter saved**.
19. Escape from the menu.

20.1.3

[1] Reporting > [3] Report Routing parameters

Use routing to program the primary and backup destination devices over standard telephone lines, local area network (LAN) or wide area network (WAN). In this menu, you can designate the primary and three backup destination devices for up to four routes.

The options include:

No Device, Phone 1, Phone 2, Phone 3, Phone 4, SDI2-1 D1, SDI2-1 D2, SDI2-1 D3, SDI2-1 D4, SDI2-2 D1, SDI2-2 D2, SDI2-2 D3, SDI2-2 D4, Onboard D1, Onboard D2, Onboard D3, Onboard D4, Cellular D1, Cellular D2, Cellular D3, Cellular D4.

		Route 1	Route 2	Route 3	Route 4
Primary destination device	No Device	_____	_____	_____	_____
Backup destination device	No Device	_____	_____	_____	_____
Second backup destination device	No Device	_____	_____	_____	_____
Third backup destination device	No Device	_____	_____	_____	_____

Primary destination device

1. Enter the installer passcode, and then open the [1] **Installer Menu**.
2. Go to [1] **Programming Menu** > [1] **Reporting** > [3] **Routing**.
3. Use **←/Previous** or **→/Next** to scroll through the list of routes and go to the route you want to program.
4. Press **Edit** or **Enter** to edit the route.
5. Use **←/Previous** or **→/Next** to scroll through the list of destinations and go to the destination device you want to select for the primary destination device. To keep the primary destination device, escape from the menu. To change to a different destination device, press **Edit Destination**.
6. Press **Save** or **Enter**. The keypad shows **Parameter saved**.
7. Escape from the menu.

Backup destination device, second backup destination device, and third backup destination device

Notice!

You can select the backup destination device only after you select a primary destination device.

You can select the second backup destination device only after you select the backup destination device.

You can select the third backup destination device only after you select the second backup destination device.



1. Enter the installer passcode, and then open the [1] **Installer Menu**.
2. Go to [1] **Programming Menu** > [1] **Reporting** > [3] **Routing**.
3. Use **←/Previous** or **→/Next** to scroll through the list of routes and go to the route you want to program.
4. Press **Edit** or **Enter** to edit the route.
5. Use **←/Previous** or **→/Next** to scroll through the list of destination devices and go to the destination device you want to select for the backup destination device. To keep the backup destination device, escape from the menu. To change to a different destination device, press **Edit Destination**.
6. Press **Save** or **Enter**. The keypad shows **Parameter saved**.
7. Repeat step 5 and 6 for the second backup destination device and the third backup destination device.
8. Escape from the menu.

20.1.4

[1] Reporting > [4] Personal Note menu parameters

The control panel can send text messages and emails for personal notification over Ethernet or using a cellular communicator. You can configure up to 16 destinations using a combination of cellular phone numbers and email addresses. The system considers an email address valid if you copy it exactly as it appears from an internet email provider. In this menu, you can add a phone number or email address to each personal notification identifier (1 through 16).

Notification Number	Phone number or email address
1	_____
2	_____
3	_____
4	_____
5	_____
6	_____
7	_____
8	_____
9	_____
10	_____
11	_____
12	_____
13	_____
14	_____
15	_____
16	_____

Personal Note

1. Enter the installer passcode, and then open the [1] **Installer Menu**.

2. Go to [1] **Programming Menu** > [1] **Reporting** > [4] **Personal Note**. The keypad shows the phone number or email address of the selected personal notification destination.
3. Use **←/Previous** or **→/Next** to scroll through the list of destinations and go to the destination you want to program.
4. Press **Edit** or **Enter** to edit the phone number or email address.
5. Delete existing characters, if necessary, and then enter the new characters.
6. Press **Save** or **Enter**. The keypad shows **Parameter saved**.

20.1.5

[2] Network > [1] Ethernet > (choose the bus module or on-board) > [1] Module Parameters menu

You can use DHCP/AutoIP or UPnP for Ethernet communication with the on-board Ethernet or a B426. In this menu, you can enable and disable these protocols.

	Default	Module settings
DHCP/AutoIP Enable	Yes	Yes/No
UPnP Enable	Yes	Yes/No
IPv4 Address	0.0.0.0	_____
IPv4 Subnet Mask	255.255.255.255	_____
Default Gateway	0.0.0.0	_____
HTTP Port Number	80	_____
IPv4 Server Address	0.0.0.0	_____
IPv6 Server Address	0.0.0.0	_____
Module Hostname	Blank	_____

DHCP/AutoIP Enable

1. Enter the installer passcode, and then open the [1] **Installer Menu**.
2. Go to [1] **Programming Menu** > [2] **Network** > [1] **Ethernet** > (choose the bus module or on-board) > [1] **Module Parameters** > [1] **DHCP Enable**. The keypad shows the DHCP/AutoIP current configuration.
3. Depending on the keypad model:
Press **Yes** or **No**.
-or-
Press **Enter** to edit the DHCP/AutoIP Enable configuration for the module. Use **Previous** or **Next** to toggle between **Yes** and **No**.
4. Press **Save** or **Enter**. The keypad shows **Parameter saved**.
5. Escape from the menu.

UPnP Enable

1. Enter the installer passcode, and then open the [1] **Installer Menu**.
2. Go to [1] **Programming Menu** > [2] **Network** > [1] **Ethernet** > (choose the bus module or on-board) > [1] **Module Parameters** > [2] **UPnP Enable**. The keypad shows the UPnP current configuration.
3. Depending on the keypad model:
Press **Yes** or **No**.
-or-



Press **Enter** to edit the UPnP Enable configuration for the module. Use **Previous** or **Next** to toggle between **Yes** and **No**..

4. Press **Save** or **Enter**. The keypad shows **Parameter saved**.
5. Escape from the menu.



20.1.6

[2] Network > [1] Ethernet > (choose the bus module or on-board) > [2] Address Parameters menu



IPv4 Address

1. Enter the installer passcode, and then open the [1] **Installer Menu**.
2. Go to [1] **Programming Menu** > [2] **Network** > [1] **Ethernet** > (choose the bus module or on-board) > [1] **Module Parameters** > [2] **Address Parameters** > [1] **IP Address**.
3. Press **Edit** or **Enter** to edit the IP address.
4. Delete the existing number, if necessary, and then enter the new number. Use /**Previous** or /**Next** to move through the different bytes.
5. Press **Save** or **Enter**. The keypad shows **Parameter saved**.
6. Escape from the menu.

IPv4 Subnet Mask

1. Enter the installer passcode, and then open the [1] **Installer Menu**.
2. Go to [1] **Programming Menu** > [2] **Network** > [1] **Ethernet** > (choose the bus module or on-board) > [1] **Module Parameters** > [2] **Subnet Mask**.
3. Press **Edit** or **Enter** to edit the subnet mask address.
4. Delete the existing number, if necessary, and then enter the new number. Use /**Previous** or /**Next** to move to a different byte.
5. Press **Save** or **Enter**. The keypad shows **Parameter saved**.
6. Escape from the menu.

Default Gateway



1. Enter the installer passcode, and then open the [1] **Installer Menu**.
2. Go to [1] **Programming Menu** > [2] **Network** > [1] **Ethernet** > (choose the bus module or on-board) > [2] **Address Parameters** > [3] **Default Gateway**.
3. Press **Edit** or **Enter** to edit the gateway.
4. Delete the existing number, if necessary, and then enter the new number. Use /**Previous** or /**Next** to move to a different byte.
5. Press **Save** or **Enter**. The keypad shows **Parameter saved**.
6. Escape from the menu.

HTTP Port Number



1. Enter the installer passcode, and then open the [1] **Installer Menu**.
2. Go to [1] **Programming Menu** > [2] **Network** > [1] **Ethernet** > (choose the bus module or on-board) > [2] **Address Parameters** > [4] **Port Number**.
3. Press **Edit** or **Enter** to edit the port number.
4. Delete the existing number, if necessary, and then enter the new number.
5. Press **Save** or **Enter**. The keypad shows **Parameter saved**.
6. Escape from the menu.

20.1.7 [2] Network > [1] Ethernet > (choose the bus module or on-board) > [3] DNS Parameters menu



IPv4 Server Address

1. Enter the installer passcode, and then open the [1] **Installer Menu**.
2. Go to [1] **Programming Menu** > [2] **Network** > [1] **Ethernet** > (choose the bus module or on-board) > [3] **DNS Parameters** > [1] **IPv4 Server Addr**. The keypad shows the IPv4 Server Address current configuration.
3. Press **Edit** or **Enter** to edit the IPv4 Server Address.
4. Delete the existing number, if necessary, and then enter the new number. Use /**Previous** or /**Next** to move to a different byte.
5. Press **Save** or **Enter**. The keypad shows **Parameter saved**.
6. Escape from the menu.

IPv6 Server Address

1. Enter the installer passcode, and then open the [1] **Installer Menu**.
2. Go to [1] **Programming Menu** > [2] **Network** > [1] **Ethernet** > (choose the bus module or on-board) > [3] **DNS Parameters** > [2] **IPv6 Server Addr**. The keypad shows the IPv6 Server Address current configuration.
3. Press **Edit** or **Enter** to edit the IPv6 Server Address.
4. Delete the existing number, if necessary, and then enter the new number. Use /**Previous** or /**Next** to move to a different byte.
5. Press **Save** or **Enter**. The keypad shows **Parameter saved**.
6. Escape from the menu.

Module Hostname

1. Enter the installer passcode, and then open the [1] **Installer Menu**.
2. Go to [1] **Programming Menu** > [2] **Network** > [1] **Ethernet** > (choose the bus module or on-board) > [3] **DNS Parameters** > [3] **Module Hostname**. The keypad shows the current hostname.
3. Press **Edit** or **Enter** to edit the hostname.
4. Delete the existing number, if necessary, and then enter the new number. Use /**Previous** or /**Next** to move to a different byte.
5. Press **Save** or **Enter**. The keypad shows **Parameter saved**.
6. Escape from the menu.

20.1.8 [2] Network > [2] Cellular > (choose the SDI2 cellular module or plug-in module)

You can use a B44x cellular communication module for communication. Plug it directly into the control panel or use it with a B450 module.

	Module 1 settings	Module 2 settings
Access Point Name	_____	_____
Access Pt Username	_____	_____
Access Pt Passcode	_____	_____
SIM PIN	_____	_____

Access Point Name

1. Enter the installer passcode, and then open the [1] **Installer Menu**.
2. Go to [1] **Programming Menu** > [2] **Network** > [2] **Cellular** > (choose the SDI2 cellular module or plug-in module) > [1] **Access Point Name**. The keypad shows the current configuration.
3. Press **Edit** or **Enter** to edit the configuration.
4. Delete existing characters, if necessary, and then enter the new characters.
5. Press **Save** or **Enter**. The keypad shows **Parameter saved**.

Access Pt Username

1. Enter the installer passcode, and then open the [1] **Installer Menu**.
2. Go to [1] **Programming Menu** > [2] **Network** > [2] **Cellular** > (choose the SDI2 cellular module or plug-in module) > [2] **Access Pt Username**. The keypad shows the current configuration.
3. Press **Edit** or **Enter** to edit the configuration.
4. Delete existing characters, if necessary, and then enter the new characters.
5. Press **Save** or **Enter**. The keypad shows **Parameter saved**.

Access Pt Passcode

1. Enter the installer passcode, and then open the [1] **Installer Menu**.
2. Go to [1] **Programming Menu** > [2] **Network** > [2] **Cellular** > (choose the SDI2 cellular module or plug-in module) > [3] **Access Pt Password**. The keypad shows the current configuration.
3. Press **Edit** or **Enter** to edit the configuration.
4. Delete existing characters, if necessary, and then enter the new characters.
5. Press **Save** or **Enter**. The keypad shows **Parameter saved**.

SIM PIN

1. Enter the installer passcode, and then open the [1] **Installer Menu**.
2. Go to [1] **Programming Menu** > [2] **Network** > [2] **Cellular** > (choose the SDI2 cellular module or plug-in module) > [4] **SIM PIN**. The keypad shows the current configuration.
3. Press **Edit** or **Enter** to edit the configuration.
4. Delete existing characters, if necessary, and then enter the new characters.
5. Press **Save** or **Enter**. The keypad shows **Parameter saved**.

20.1.9**[3] RPS > [1] RPS Passcode menu parameters**

The control panel verifies the remote programming software at the central station has valid access before connecting using the RPS passcode. In this menu, you can program the RPS passcode.

RPS Passcode

1. Enter the installer passcode, and then open the [1] **Installer Menu**.
2. Go to [1] **Programming Menu** > [3] **RPS** > [1] **RPS Passcode**.
3. Press **Edit** or **Enter** to edit the RPS passcode.
4. Delete the existing number, if necessary, and enter the new number.
5. Press **Save** or **Enter**. The keypad shows **Parameter saved**.
6. Escape from the menu.

20.1.10 [3] RPS > [2] RPS Phone Number menu parameters

The RPS Phone Number is the number the control panel dials to contact RPS or the Installer Services Portal programming tool (available in Europe, Middle East, Africa, and China). In this menu, you can program the RPS phone number.



RPS Phone Number

1. Enter the installer passcode, and then open the [1] **Installer Menu**.
2. Go to [1] **Programming Menu** > [3] **RPS** > [2] **RPS Phone Number**.
3. Press **Edit** or **Enter** to edit the RPS phone number.
4. Delete the existing number, if necessary, and then enter the new number.
5. Press **Save** or **Enter**. The keypad shows **Parameter saved**.
6. Escape from the menu.

20.1.11 [3] RPS > [3] RPS IP Address menu parameters

The control panel can use a network hostname or an IPv4 address to call RPS or the Installer Services Portal programming tool (available in Europe, Middle East, Africa, and China). In this menu, you can program the IPv4 address or hostname for RPS or Installer Services Portal programming tool communication.

RPS IP Address

1. Enter the installer passcode, and then open the [1] **Installer Menu**.
2. Go to [1] **Programming Menu** > [3] **RPS** > [3] **RPS IP Address**.
3. Depending on keypad model:
Press **Edit as IPv4** for an IP address, or **Edit as Name** for a hostname.
-or-
Use **Previous** or **Next** to toggle between the option to edit the address as an IPv4 address or as a hostname. Press **Enter** when the keypad shows the option you want to edit.
4. Delete the existing characters, if necessary, and enter the new characters. For an IPv4 address, use /Previous or /Next to move to a different byte, and use the number keys to enter the new numbers. For a hostname, press a number key repeatedly to scroll through the number and letters shown on the key.
5. Press **Save** or **Enter**. The keypad shows **Parameter saved**.
6. Escape from the menu.

20.1.12 [3] RPS > [4] RPS Port Number menu parameters

In this menu, you can specify the destination port for outgoing RPS or Installer Services Portal programming tool (available in Europe, Middle East, Africa, and China) session requests to the specified IP address.

RPS Port Number

1. Enter the installer passcode, and then open the [1] **Installer Menu**.
2. Go to [1] **Programming Menu** > [3] **RPS** > [4] **RPS Port Number**.
3. Press **Edit** or **Enter** to edit the RPS port number.
4. Delete the existing number, if necessary, and then enter the new number.
5. Press **Save** or **Enter**. The keypad shows **Parameter saved**.
6. Escape from the menu.

20.1.13

[4] Area Options menu parameters

This parameter enables or disables specified areas. Enabled areas must have assigned account numbers. In this menu, you can turn on or off areas and assign area account numbers.

**Notice!**

Account numbers can contain characters 0 through 9, and B through F.

	Area 1	Area 2	Area 3	Area 4
Area On	Yes/No	Yes/No	Yes/No	Yes/No
Account Number	_____	_____	_____	_____

Area State

1. Enter the installer passcode, and then open the [1] **Installer Menu**.
2. Go to [1] **Programming Menu** > [4] **Areas**.
3. Use **←/Previous** or **→/Next** to go to the desired area.
4. Depending on keypad model:
Press **Edit** and then **Yes** or **No**.
-or-
Press **Enter** to edit the area and **Enter** to edit the Area On state for the selected area. Use **Previous** or **Next** to toggle between the **Yes** and **No** options.
5. Press **Save** or **Enter**. The keypad shows **Parameter saved**.
6. Escape from the menu.

Area Account Number

1. Enter the installer passcode, and then open the [1] **Installer Menu**.
2. Go to [1] **Programming Menu** > [4] **Areas**.
3. Use **←/Previous** or **→/Next** to go to the desired area.
4. Depending on keypad model:
Press **Account #** and then **Edit**.
-or-
Press **Enter** to edit the area, and then press **Next** to go to the account number option.
Press **Enter** to edit the account number for the selected area.
5. Delete existing characters, if necessary, and then enter the new characters.
6. Press **Save** or **Enter**. The keypad shows **Parameter saved**.
7. Escape from the menu.

Area Account Name

1. Enter the installer passcode, and then open the [1] **Installer Menu**.
2. Go to [1] **Programming Menu** > [4] **Areas**.
3. Use **←/Previous** or **→/Next** to go to the desired area.
4. Depending on keypad model:
Press **Account #** and then **Name** and then **Edit**.
-or-
Press **Enter** to edit the area, and then press **Next** and **Next** to go to the account name option. Press **Enter** to edit the account name for the selected area.

5. Delete existing characters, if necessary, and then enter the new characters.
6. Press **Save** or **Enter**. The keypad shows **Parameter saved**.
7. Escape from the menu.

20.1.14



[5] Keypad menu parameters

The keypad scope defines which areas the keypad affects when armed (on), which areas you can view with this keypad, and the areas to which this keypad can move. In this menu, you can choose the keypad’s scope. You can also use this menu to identify the keypad type and assign it to an area.

*	Type (Circle one)	Scope (Circle one)
Keypad 1	No keypad / B91x / B92x / B93x / B94x	No Device / Area Wide / Acct Wide / Panel Wide
Keypad 2	No keypad / B91x / B92x / B93x / B94x	No Device / Area Wide / Acct Wide / Panel Wide
Keypad 3	No keypad / B91x / B92x / B93x / B94x	No Device / Area Wide / Acct Wide / Panel Wide
Keypad 4	No keypad / B91x / B92x / B93x / B94x	No Device / Area Wide / Acct Wide / Panel Wide
Keypad 5	No keypad / B91x / B92x / B93x / B94x	No Device / Area Wide / Acct Wide / Panel Wide
Keypad 6	No keypad / B91x / B92x / B93x / B94x	No Device / Area Wide / Acct Wide / Panel Wide
Keypad 7	No keypad / B91x / B92x / B93x / B94x	No Device / Area Wide / Acct Wide / Panel Wide
Keypad 8	No keypad / B91x / B92x / B93x / B94x	No Device / Area Wide / Acct Wide / Panel Wide

*Refer to your control panel for supported number of keypads..

Type
Scope
Area

1. Enter the installer passcode, and then open the [1] **Installer Menu**.
2. Go to [1] **Programming Menu** > [5] **Keypad**.
3. Use /Previous or /Next to go to the desired keypad.
4. Press **Edit** or **Enter** to edit the type.
5. Depending on keypad model:
 Press the icon or softkey for the desired type.
 -or-
 Use **Previous** or **Next** to go to the desired type.
6. Press **Save** or **Enter**. The keypad shows **Parameter saved** and then asks if you would like to edit the scope.
7. Press **Edit** or **Enter** to edit the type.
8. Depending on keypad model:
 Press the icon or softkey for the desired scope.

-or-

Use **Previous** or **Next** to go to the desired scope.

9. Press **Save** or **Enter**. The keypad shows **Parameter saved** and then asks if you would like to edit the area.
10. Press **Edit** or **Enter** to edit the type.
11. Depending on keypad model:
Press the icon or softkey for the desired area.

-or-

Use **Previous** or **Next** to go to the desired area.

12. Press **Save** or **Enter**. The keypad shows **Parameter saved**.
13. Escape from the menu.

20.1.15

[6] Users menu parameters

In this menu, you can change the Service User passcode and the passcode for User 1. To add and remove users, change users passcodes, and perform other user functions from the keypad, you must use the Users menu from the Main menu. Refer to the Control Panels (B9512G/B8512G/B5512/B4512/B3512) Owner’s Manual for more information.

Users (In the Installer menu)

1. Enter the installer passcode, and then open the [1] **Installer Menu**.
2. Go to [1] **Programming Menu** > [6] **Users**. The keypad shows the Installer passcode.
3. Use **←/Previous** or **→/Next** to toggle between user 000 (service user) and user 001 and go to the user you want to edit.
4. Press **Edit** or **Enter** to edit the selected user. The cursor flashes at the editing location.
5. Delete existing characters, if necessary, and then enter the new characters.
6. Press **Save** or **Enter**. The keypad shows **Parameter saved**.
7. Escape from the menu.

User (Passcode) Worksheet (Includes users added only through RPS, the Installer Services Portal programming tool (available in Europe, Middle East, Africa, and China), or the Main menu)

User ###	Passcode	User group	Area authority				User name
			1	2	3*	4*	
000	123 _ _ _ _	___	15	15	15	15	SERVICE PASSCODE
001	123456	___	1	_	_	_	USER 1
_ _ _ _	_ _ _ _ _ _ _ _	___	_	_	_	_	USER _ _
_ _ _ _	_ _ _ _ _ _ _ _	___	_	_	_	_	USER _ _
_ _ _ _	_ _ _ _ _ _ _ _	___	_	_	_	_	USER _ _
_ _ _ _	_ _ _ _ _ _ _ _	___	_	_	_	_	USER _ _
_ _ _ _	_ _ _ _ _ _ _ _	___	_	_	_	_	USER _ _
_ _ _ _	_ _ _ _ _ _ _ _	___	_	_	_	_	USER _ _
_ _ _ _	_ _ _ _ _ _ _ _	___	_	_	_	_	USER _ _
_ _ _ _	_ _ _ _ _ _ _ _	___	_	_	_	_	USER _ _
_ _ _ _	_ _ _ _ _ _ _ _	___	_	_	_	_	USER _ _

User ###	Passcode	User group	Area authority				User name
			1	2	3*	4*	
----	-----	---	--	--	--	--	USER ___
----	-----	---	--	--	--	--	USER ___
----	-----	---	--	--	--	--	USER ___
----	-----	---	--	--	--	--	USER ___
----	-----	---	--	--	--	--	USER ___
----	-----	---	--	--	--	--	USER ___
----	-----	---	--	--	--	--	USER ___
----	-----	---	--	--	--	--	USER ___
----	-----	---	--	--	--	--	USER ___
----	-----	---	--	--	--	--	USER ___
----	-----	---	--	--	--	--	USER ___
----	-----	---	--	--	--	--	USER ___
----	-----	---	--	--	--	--	USER ___
----	-----	---	--	--	--	--	USER ___
----	-----	---	--	--	--	--	USER ___
----	-----	---	--	--	--	--	USER ___
----	-----	---	--	--	--	--	USER ___

* Applicable to B5512 only.

20.1.16 [7] Points menu parameters

Use the parameters in this menu to assign a Point Source and a Point Profile to each point. The Point Source parameter assigns the point to a device (on-board, Octo-input, and wireless are examples). The Point Profile determines how the point operates.

Point Source selections	
Unassigned	Output
Octo-input	Keypad
Wireless	IP Camera*
On-board	

*The B426 and the B3512 do not support IP cameras.

Point Profile selections

Assign a Point Profile to a point by selecting the Point Profile number. The tables below show the Point Profile number and default configuration for each Point Profile. You must use RPS or the Installer Services Portal programming tool (available in Europe, Middle East, Africa, and China) to configure the Point Profile parameters.

Point Profiles 1 through 8

Point Profile Text defaults (the second language text defaults are blank):

Point Profile Number Default Text (first language)

- Point Profile 1 24-hr Instant on Open/Short
- Point Profile 2 24-hr Invisible/Sil on Short

Point Profile 3	Pull Station
Point Profile 4	Smoke Detector
Point Profile 5	Smoke Detector w/Verification
Point Profile 6	Bell Supervision - D192G
Point Profile 7	Part On: Instant
Point Profile 8	Part On: Delay

Point Profile Number	1	2	3	4	5	6	7	8
Point Profile Text (1st language)	24-hr Instant	24-hr Invisible/	Pull Station	Smoke Detector	Smoke Detector	Bell Supervisi	Part On: Instant	Part On: Delay
Point Profile Text (2nd language)	(blank)	(blank)	(blank)	(blank)	(blank)	(blank)	(blank)	(blank)
Point Type / Response / Circuit Style	24 Hour	24 Hour	Fire Point	Fire Point	Fire Point	24 Hour	Part On	Part On
Entry Delay	_(30)_	_(30)_	_(30)_	_(30)_	_(30)_	_(30)_	_(30)_	_(30)_
Entry Tone Off	Y/N	Y/N	Y/N	Y/N	Y/N	Y/N	Y/N	Y/N
Silent Bell	Y/N	Y/N	Y/N	Y/N	Y/N	Y/N	Y/N	Y/N
Ring Until Restored	Y/N	Y/N	Y/N	Y/N	Y/N	Y/N	Y/N	Y/N
Audible After Two Fails	Y/N	Y/N	Y/N	Y/N	Y/N	Y/N	Y/N	Y/N
Invisible Point	Y/N	Y/N	Y/N	Y/N	Y/N	Y/N	Y/N	Y/N
Buzz on Fault	_(0)_	_(0)_	_(0)_	_(0)_	_(0)_	_(0)_	_(0)_	_(0)_
Watch Point	Y/N	Y/N	Y/N	Y/N	Y/N	Y/N	Y/N	Y/N
Output Response Type	_(0)_	_(0)_	_(0)_	_(0)_	_(0)_	_(0)_	_(0)_	_(0)_
Display as Device	Y/N	Y/N	Y/N	Y/N	Y/N	Y/N	Y/N	Y/N
Local While Disarmed	Y/N	Y/N	Y/N	Y/N	Y/N	Y/N	Y/N	Y/N
Local While Armed	Y/N	Y/N	Y/N	Y/N	Y/N	Y/N	Y/N	Y/N
Disable Restorals	Y/N	Y/N	Y/N	Y/N	Y/N	Y/N	Y/N	Y/N
Force Arm Returnable	Y/N	Y/N	Y/N	Y/N	Y/N	Y/N	Y/N	Y/N
Bypass Returnable	Y/N	Y/N	Y/N	Y/N	Y/N	Y/N	Y/N	Y/N
Bypassable	Y/N	Y/N	Y/N	Y/N	Y/N	Y/N	Y/N	Y/N
Swinger Bypass	Y/N	Y/N	Y/N	Y/N	Y/N	Y/N	Y/N	Y/N
Report Bypass at Occurrence	Y/N	Y/N	Y/N	Y/N	Y/N	Y/N	Y/N	Y/N
Defer Bypass Report	Y/N	Y/N	Y/N	Y/N	Y/N	Y/N	Y/N	Y/N
Cross Point	Y/N	Y/N	Y/N	Y/N	Y/N	Y/N	Y/N	Y/N
Alarm Verify	Y/N	Y/N	Y/N	Y/N	Y/N	Y/N	Y/N	Y/N

Point Profile Number	1	2	3	4	5	6	7	8
Resettable	Y/N	Y/N	Y/N	Y/N	Y/N	Y/N	Y/N	Y/N
Alarm Abort	Y/N	Y/N	Y/N	Y/N	Y/N	Y/N	Y/N	Y/N
Wireless Point Supervision Time	___	___	(4)___	(4)___	(4)___	(4)___	___	___
Custom Function	Disabled	Disabled	Disabled	Disabled	Disabled	Disabled	Disabled	Disabled
Monitor Delay	00:00	00:00	00:00	00:00	00:00	00:00	00:00	00:00
Delay Response Disarmed	00:00	00:00	00:00	00:00	00:00	00:00	00:00	00:00
Delay Response Armed	00:00	00:00	00:00	00:00	00:00	00:00	00:00	00:00

Point Profiles 9 through 16

Point Profile Text defaults (the second language text defaults are blank):

Point Profile Number Default text (first language)

- Point Profile 9 Part Instant, Local Disarmed, Buzz
- Point Profile 10 Interior: Instant
- Point Profile 11 Interior: Delay
- Point Profile 12 Interior: Instant, Local Disarmed
- Point Profile 13 Interior: Follower
- Point Profile 14 Maintained Keyswitch
- Point Profile 15 Momentary Keyswitch
- Point Profile 16 Point Opening/Closing

Point Profile Number	9	10	11	12	13	14	15	16
Point Profile Text (1st language)	Part Instant	Interior: Instant	Interior: Delay	Interior: Instant	Interior: Follower	Maintained Key	Momentary Key	Point Opening/
Point Profile Text (2nd language)	(blank)	(blank)	(blank)	(blank)	(blank)	(blank)	(blank)	(blank)
Point Type / Response / Circuit Style	Part On	Interior	Interior	Interior	Interior Follower	Keyswitch Maintained	Keyswitch Momentary	Open/Close
Entry Delay	_ (30)_	_ (30)_	_ (30)_	_ (30)_	_ (30)_	_ (30)_	_ (30)_	_ (30)_
Entry Tone Off	Y/N	Y/N	Y/N	Y/N	Y/N	Y/N	Y/N	Y/N
Silent Bell	Y/N	Y/N	Y/N	Y/N	Y/N	Y/N	Y/N	Y/N
Ring Until Restored	Y/N	Y/N	Y/N	Y/N	Y/N	Y/N	Y/N	Y/N
Audible After Two Fails	Y/N	Y/N	Y/N	Y/N	Y/N	Y/N	Y/N	Y/N
Invisible Point	Y/N	Y/N	Y/N	Y/N	Y/N	Y/N	Y/N	Y/N
Buzz on Fault	__(1)__	__(0)__	__(0)__	__(0)__	__(0)__	__(0)__	__(0)__	__(0)__

Point Profile Number	9	10	11	12	13	14	15	16
Watch Point	Y/N	Y/N	Y/N	Y/N	Y/N	Y/N	Y/N	Y/N
Output Response Type	__ (1) __	__ (0) __	__ (0) __	__ (0) __	__ (0) __	__ (0) __	__ (0) __	__ (0) __
Display as Device	Y/N	Y/N	Y/N	Y/N	Y/N	Y/N	Y/N	Y/N
Local While Disarmed	Y/N	Y/N	Y/N	Y/N	Y/N	Y/N	Y/N	Y/N
Local While Armed	Y/N	Y/N	Y/N	Y/N	Y/N	Y/N	Y/N	Y/N
Disable Restorals	Y/N	Y/N	Y/N	Y/N	Y/N	Y/N	Y/N	Y/N
FA Returnable	Y/N	Y/N	Y/N	Y/N	Y/N	Y/N	Y/N	Y/N
Bypass Returnable	Y/N	Y/N	Y/N	Y/N	Y/N	Y/N	Y/N	Y/N
Bypassable	Y/N	Y/N	Y/N	Y/N	Y/N	Y/N	Y/N	Y/N
Swinger Bypass	Y/N	Y/N	Y/N	Y/N	Y/N	Y/N	Y/N	Y/N
Report Bypass at Occurrence	Y/N	Y/N	Y/N	Y/N	Y/N	Y/N	Y/N	Y/N
Defer Bypass Report	Y/N	Y/N	Y/N	Y/N	Y/N	Y/N	Y/N	Y/N
Cross Point	Y/N	Y/N	Y/N	Y/N	Y/N	Y/N	Y/N	Y/N
Alarm Verify	Y/N	Y/N	Y/N	Y/N	Y/N	Y/N	Y/N	Y/N
Resettable	Y/N	Y/N	Y/N	Y/N	Y/N	Y/N	Y/N	Y/N
Alarm Abort	Y/N	Y/N	Y/N	Y/N	Y/N	Y/N	Y/N	Y/N
Wireless Point Supervision Time** (None)	---	---	---	---	---	---	---	---
Custom Function	Disabled	Disabled	Disabled	Disabled	Disabled	Disabled	Disabled	Disabled
Monitor Delay	00:00	00:00	00:00	00:00	00:00	00:00	00:00	00:00
Delay Response Disarmed	00:00	00:00	00:00	00:00	00:00	00:00	00:00	00:00
Delay Response Armed	00:00	00:00	00:00	00:00	00:00	00:00	00:00	00:00

Point Profiles 17 through 20

Point Profile Text defaults (the second language text defaults are blank):

Point Profile Number Default text (first language)

- Point Profile 17 Gas
- Point Profile 18 Gas: Supervisory
- Point Profile 19 Aux AC Supervision
- Point Profile 20 Part On: Watch Off

Point Profile #	17	18	19	20
Point Profile Text (1st language)	Gas	Gas Supervisi	Aux AC Supervisi	Part On Watch Off

Point Profile Text (2nd language)	(blank)	(blank)	(blank)	(blank)
Point Type / Response / Circuit Style	Gas Point	Gas Point	Aux AC Supervisi	Part On
Entry Delay	_(30)_	_(30)_	_(30)_	_(30)_
Entry Tone Off	Y/N	Y/N	Y/N	Y/N
Silent Bell	Y/N	Y/N	Y/N	Y/N
Ring Until Restored	Y/N	Y/N	Y/N	Y/N
Audible After Two Fails	Y/N	Y/N	Y/N	Y/N
Invisible Point	Y/N	Y/N	Y/N	Y/N
Buzz on Fault	_(0)_	_(0)_	_(0)_	_(0)_
Watch Point	Y/N	Y/N	Y/N	Y/N
Output Response Type	_(0)_	_(0)_	_(0)_	_(0)_
Display as Device	Y/N	Y/N	Y/N	Y/N
Local While Disarmed	Y/N	Y/N	Y/N	Y/N
Local While Armed	Y/N	Y/N	Y/N	Y/N
Disable Restorals	Y/N	Y/N	Y/N	Y/N
FA Returnable	Y/N	Y/N	Y/N	Y/N
Bypass Returnable	Y/N	Y/N	Y/N	Y/N
Bypassable	Y/N	Y/N	Y/N	Y/N
Swinger Bypass	Y/N	Y/N	Y/N	Y/N
Report Bypass at Occurrence	Y/N	Y/N	Y/N	Y/N
Defer Bypass Report	Y/N	Y/N	Y/N	Y/N
Cross Point	Y/N	Y/N	Y/N	Y/N
Alarm Verify	Y/N	Y/N	Y/N	Y/N
Resettable	Y/N	Y/N	Y/N	Y/N
Alarm Abort	Y/N	Y/N	Y/N	Y/N
Wireless Point Supervision Time** (None)	—	—	—	—
Custom Function	Disabled	Disabled	Disabled	Disabled
Monitor Delay	00:00	00:00	00:00	00:00
Delay Response Disarmed	00:00	00:00	00:00	00:00
Delay Response Armed	00:00	00:00	00:00	00:00

Point worksheet

**Caution!**

Any points programmed as fire supervisory points are latching.

Point Profile**Point Source****Point Area****Point Name**

1. Enter the installer passcode, and then open the [1] **Installer Menu**.
2. Go to [1] **Programming Menu** > [7] **Points**.
3. Enter the point number and press **Enter**, or use /Previous or /Next to go to the desired point.
4. Press **Edit** or **Enter** to edit the profile for the selected point.
5. Use /Previous or /Next to go the desired profile.
6. Press **Save** or **Enter**. The keypad shows **Parameter saved**.
7. Press **Source** or use /Next to go to the source option.
8. Press **Edit** or **Enter** to edit the source for the selected point.
9. Use /Previous or /Next to go the desired source.
10. Press **Save** or **Enter**. The keypad shows **Parameter saved**.
11. Press **Area** or use /Next to go to the area option.
12. Press **Edit** or **Enter** to edit the area for the selected point.
13. Use /Previous or /Next to go the desired area.
14. Press **Save** or **Enter**. The keypad shows **Parameter saved**.
15. Press **Name** or use /Next to go to the source option.
16. Press **Edit** or **Enter** to edit the name for the selected point.
17. Delete the existing characters, if necessary, and enter the new characters.
18. Press **Save** or **Enter**. The keypad shows **Parameter saved**.

20.1.17**[8] Disable Programming menu**

The Keypad Installer menu is enabled by default. When enabled, the Service User (Authority Level 15) has authority to access the menus. If you disable Keypad Programming, the Service User cannot access the menus. In this menu, you can disable Keypad Programming.

**Notice!**

You can continue using the current programming session. Disabling Keypad Programming applies once you exit the current session.

Keypad Programming

1. Enter the installer passcode, and then open the [1] **Installer Menu**.
2. Go to [1] **Programming Menu** > [8] **Disable**. The keypad shows that programming is enabled.
3. Depending on keypad model:
Press **Edit** and then press **No**.
-or-

Press **Enter** and then press **Next** to view the **No** option.

4. Press **Save** or **Enter**. The keypad shows **Parameter saved**.
5. Escape from the menu.

20.2 [2] Wireless menu

Use the Wireless menu to add, replace, remove, and diagnose points and repeaters.

20.2.1 [1] RF Point Menu> [1] Enroll Point RFID

Once the control panel has points programmed as Wireless, you can enroll RF devices into the system as a specified wireless points. In this menu, you can enroll RFID points.

Enroll point RFID

1. Enter the installer passcode, and then open the [1] **Installer Menu**.
2. Go to [2] **Wireless** > [1] **RF Point Menu** > [1] **Enroll point RFID**. The keypad lists any enrolled points.
3. Use **←/Previous** or **→/Next** to scroll through the list of wireless points, and go to the point for which you want to enroll a device, or simply enter the point number.
4. Press **Yes** or **Enter** to add the device. The keypad instructs you to reset the device.
5. Initiate activity for the desired RADION device (walk through the coverage pattern if enrolling a motion detector, or press the button on the keyfob if enrolling a keyfob, or open the door or window if enrolling a door/window contact), or press the RESET button on an Inovonics device.
6. When the keypad indicates that the point enrolled, escape from the menu.
7. Verify the RFID shown on the keypad matches the RFID label on the activated device.

20.2.2 [1] RF Point Menu> [2] Replace Point RFID

In this menu, you can replace RFID points.

Replace Point RFID

1. Enter the installer passcode, and then open the [1] **Installer Menu**.
2. Go to [2] **Wireless** > [1] **RF Point Menu** > [2] **Replace Point RFID**. The keypad lists any enrolled points.
3. Use **←/Previous** or **→/Next** to scroll through the list of wireless points, and go to the point for which you want to replace the device, or simply enter the point number.
4. Press **Enter** to replace the device. The keypad instructs you to reset the device.
5. Initiate activity for the desired RADION device (walk through the coverage pattern if enrolling a motion detector, or press the button on the keyfob if enrolling a keyfob, or open the door or window if enrolling a door/window contact), or press the RESET button on an Inovonics device.
6. When the keypad indicates that the point was replaced, escape from the menu.
7. Verify the RFID shown on the keypad matches the RFID label on the activated device.

20.2.3 [1] RF Point Menu> [3] Remove Point RFID

In this menu, you can remove RFID points.

Remove Point RFID

1. Enter the installer passcode, and then open the [1] **Installer Menu**.
2. Go to [2] **Wireless** > [1] **RF Point Menu** > [3] **Remove Point RFID**. The keypad lists any enrolled points.

3. Use **←/Previous** or **→/Next** to scroll through the list of wireless points, and go to the point for which you want to remove, or simply enter the point number.
4. Press **Remove** or **Enter** to remove the device. The keypad shows **Point RFID removed**.
5. Escape from the menu.

20.2.4

[2] RF Repeater Menu > [1] Add Repeater

In this menu, you can add repeater points.

Add Repeater

1. Ensure that the repeater is in a normal state.
2. Enter the installer passcode, and then open the [1] **Installer Menu**.
3. Go to [2] **Wireless** > [2] **RF Repeater Menu** > [1] **Add Repeater**. The keypad lists any repeaters.
4. Use **←/Previous** or **→/Next** to scroll through the list, and go to the repeater number for which you want to add a repeater, or enter the repeater number. Start with address 8 before adding additional repeaters.
5. Press **Enter** to add the repeater. The keypad instructs you to tamper the repeater.
6. Initiate discovery on a RADION repeater by opening the cover, or press the RESET button on an Inovonics repeater.
7. When the keypad indicates that the repeater was added, escape from the menu.

20.2.5

[2] RF Repeater Menu > [2] Replace Repeater

In this menu, you can replace Repeater points.

Replace Repeater

1. Enter the installer passcode, and then open the [1] **Installer Menu**.
2. Go to [2] **Wireless** > [2] **RF Repeater Menu** > [2] **Replace Repeater**. The keypad lists any existing repeaters.
3. Use **←/Previous** or **→/Next** to scroll through the list of repeaters, and go to the repeater you want to replace, or simply enter the repeater number.
4. Press **Enter** to replace the device. The keypad instructs you to reset the new device.
5. Initiate discovery on a RADION device per the device instructions, or press the RESET button on an Inovonics device.
6. When the keypad indicates that the repeater was replaced, escape from the menu.

20.2.6

[2] RF Repeater Menu > [3] Remove Repeater

In this menu, you can replace Repeater points.

Remove Repeater

1. Enter the installer passcode, and then open the [1] **Installer Menu**.
2. Go to [2] **Wireless** > [2] **RF Repeater Menu** > [3] **Remove Repeater**. The keypad lists any existing repeaters.
3. Use **←/Previous** or **→/Next** to scroll through the list of repeaters, and go to the repeater you want to remove, or simply enter the repeater number.
4. Press **Enter** to remove the device. The keypad removes the device and shows **Repeater removed**.
5. Escape from the menu.

20.2.7

[3] RF Diagnostic Menu > [1] RF Points

You can obtain certain wireless point diagnostic information using a keypad and this menu.

Point State

1. Enter the installer passcode, and then open the [1] **Installer Menu**.
2. Go to [2] **Wireless** > [3] **RF Diagnostic Menu** > [1] **RF Point Diagnostic** > [1] **Point State**.
3. Use **←/Previous** or **→/Next** to scroll through the list, and go to the point for which you want to view diagnostic information, or enter the point number.
4. Press **Enter** to view the state. The menu scrolls through the following sub-categories, with the results of the diagnostic check: **State, Tamper, Low-Battery, Maintenance**.
5. When finished viewing the information, escape from the menu.

Point Signal

1. Enter the installer passcode, and then open the [1] **Installer Menu**.
2. Go to [2] **Wireless** > [3] **RF Diagnostic Menu** > [1] **RF Point Diagnostic** > [2] **Point Signal**.
3. Use **←/Previous** or **→/Next** to scroll through the list, and go to the point for which you want to view diagnostic information, or enter the point number.
4. Press **Enter** to view the signal strength. The menu scrolls through the following sub-categories, with the results of the diagnostic check: **Signal Strengths, Level, Margin**.
5. When finished viewing the information, escape from the menu.

20.2.8**[3] RF Diagnostic Menu > [2] RF Repeater Menu**

You can obtain certain wireless point diagnostic information using a keypad and this menu.

Repeater State

1. Enter the installer passcode, and then open the [1] **Installer Menu**.
2. Go to [2] **Wireless** > [3] **RF Diagnostic Menu** > [2] **RF Repeater Menu** > [1] **Repeater State**.
3. Use **←/Previous** or **→/Next** to scroll through the list, and go to the repeater for which you want to view diagnostic information, or enter the repeater number.
4. Press **Enter** to view the state. The menu scrolls through the following sub-categories, with the results of the diagnostic check: **State, Missing, Tamper, Low-Battery**.
5. When finished viewing the information, escape from the menu.

Repeater Signal

1. Enter the installer passcode, and then open the [1] **Installer Menu**.
2. Go to [2] **Wireless** > [3] **RF Diagnostic Menu** > [2] **RF Repeater Menu** > [1] **Repeater Signal**.
3. Use **←/Previous** or **→/Next** to scroll through the list, and go to the repeater for which you want to view diagnostic information, or enter the repeater number.
4. Press **Enter** to view the signal strength. The menu scrolls through the following sub-categories, with the results of the diagnostic check: **Signal Strengths, Level, Margin**.
5. When finished viewing the information, escape from the menu.

20.3**[3] Diags menu**

Use the Diagnostics menu to view available diagnostics.

20.3.1**[1] Wireless**

The Wireless diagnostics are presented in two different menus for your convenience. Refer to *[3] RF Diagnostic Menu > [1] RF Points, page 124* and *[3] RF Diagnostic Menu > [2] RF Repeater Menu, page 125*.

20.3.2

[2] Network menu

Use the Network menu to view information about the control panel's network connection.

Settings

1. Enter the installer passcode, and then open the [1] **Installer Menu**.
2. Go to [3] **Diagnostics Menu** > [2] **Network** > (choose the bus module or on-board) > [1] **Settings**. The keypad the following sub-categories, indicating the programming for: **Host Name**:, **IPv4 Source IP**:, **IPv6 Source IP**:, **MAC Addr**:. (Use /Next to scroll through, if necessary.)
3. When finished viewing the information, escape from the menu.

Connection

1. Enter the installer passcode, and then open the [1] **Installer Menu**.
2. Go to [3] **Diagnostics Menu** > [2] **Network** > (choose the bus module or on-board) > [2] **Connection**. The keypad scrolls through the following sub-categories, indicating the connection status for: **Link**, **IP Address**, **DNS**, **LAN**, **WAN**. (Use /Next to scroll through, if necessary.)
3. When finished viewing the information, escape from the menu.

20.3.3

[3] Cellular menu

You can obtain certain cellular module diagnostic information using a keypad and this menu.

Cellular (diagnostics)

1. Enter the installer passcode, and then open the [1] **Installer Menu**.
2. Go to [3] **Diagnostics Menu** > [3] **Cellular** > (choose the SDI2 cellular module or plug-in module). The keypad scrolls through the following sub-categories, indicating the diagnostic information. (Use /Next to scroll through, if necessary.)
 - **Link** (Yes or No. Yes indicates a data connection to the carrier. No indicates a connection problem.)
 - **IPv4 IP** (The IP address of the cellular radio on the carrier's network.)
 - **Base ID**
 - **Signal** (Signal strength = unacceptable, marginal, good, or very good.)
 - **Signal** (In dBs.)
 - **Tel Num** (If provided by the carrier.)
 - **ESN** (The cellular radio electronic serial number.)
 - **Model** (The cellular radio model.)
 - **Version** (The cellular radio version.)
3. When finished viewing the information, escape from the menu.

20.3.4

[4] IP Camera

IP Camera



1. Enter the installer passcode, and then open the [1] **Installer Menu**.
2. Go to [3] **Diagnostics Menu** > [4] **IP Camera**. The keypad shows one of the following statuses:
 - **Not Configured**
 - **Not Responding**
 - **Bad Password**
 - **Online**
 - **Missing**

3. When finished viewing the information, escape from the menu.

20.3.5

[5] Cloud

Cloud

1. Enter the installer passcode, and then open the [1] **Installer Menu**.
2. Go to [3] **Diagnostics Menu** > [5] **Cloud**. The keypad shows the Cloud ID, which is also on a label on the control panel.
3. Press /Next. The keypad shows the Cloud configuration, which is one of the following:
 - Not Available
 - Enabled on Ethernet
 - Enabled on Cellular
 - Enabled on Ethernet and Cellular
4. Press /Next. The keypad shows the Cloud Certificate status, which is one of the following:
 - Not Installed
 - Certificate Valid
5. Press /Next. The keypad shows the Cloud state, which is one of the following:
 - Connected (and through which method)
 - Not Ready
 - Disconnected
 - Not Available
 - Trying to Connect
6. When finished viewing the information, escape from the menu.

20.4

[4] Service Bypass (Serv Byp) menu

In this menu, you can edit the Service Bypass points.

Service Bypass



1. Enter the installer passcode, and then open the [1] **Installer Menu**.
2. Go to [4] **Service Bypass**. If no points have been bypassed the keypad shows **No points bypassed**. If points are bypassed, the keypad lists the number of bypassed points.
3. Enter number for the point to bypass, and then press **Enter** to select the point.
4. Press **Enter** to bypass the point. The keypad shows **Parameter saved** , and then returns to the point you just bypassed.
5. Escape from the menu.

20.5

[5] Versions menu

Use the Versions menu to view control panel version information.

Versions

1. Enter the installer passcode, and then open the [1] **Installer Menu**.
2. Go to [5] **Versions**.
3. Depending on keypad model:
Press the icon or softkey for the item for which you want view the version.
-or-
Use /Previous or /Next to scroll through the list of items for which you can view the version. Press **Enter** to view the version.
4. Escape from the menu.

20.6

[6] Cloud menu

Use the Cloud menu to enable or disable the Cloud capability in the control panel.

Cloud

1. Enter the installer passcode, and then open the [1] **Installer Menu**.
2. Go to [6] **Cloud**. The keypad shows the current status; **Disabled**, **Enabled on Ethernet**, **Enabled on cellular**, or **Enabled on both Ethernet and Cellular**.
3. Press **Edit** or **Enter** (or escape from the menu to exit without making a change).
4. Use /Next to go to the desired option.
5. Press **Save** or **Enter**. The keypad shows **Parameter saved** and closes the menu.

21 Specifications

Control panel power supply specifications

Voltage input (power supply)	Primary	18 VAC terminals	18 VAC 22 VA class 2 transformer
	Secondary	BAT terminals	12 Volt Sealed Lead Acid Rechargeable Battery (D126 or D1218)
Current requirements	Control Panel: Idle 125 mA; Alarm 155 mA Refer to the Standby battery requirements and calculations section in the control panel Installation and System Reference Guide for the current draw requirements of other system components.		
Power outputs	All external connections are power-limited. The battery terminals are not power limited.		
	SDI2 terminals and interconnect connector	PWR/R and COM/B terminals	800 mA for continuously powered devices. Shared with AUX power terminal.
	Alarm power output	OUTPUT A terminal	1.3 A for Burglary applications. Output can be steady or one of four pulsed patterns depending on programming. Refer to Outputs in RPS Help, in the Installer Services Portal programming tool (available in Europe, Middle East, Africa, and China) Help, or in the control panel Program Entry Guide.
	Aux power	AUX and COM terminals	800 mA for continuously powered devices. Shared with SDI2 R/PWR terminal and interconnect connector.
	Fire and Fire/Burglary Systems	Alarm power output for OUTPUT A cannot exceed 500 mA.	
Minimum operating voltage	10.2 VDC (The control panel might operate below this voltage, but it will cease to operate as an alarm panel.)		
SDI2 bus	12 VDC nominal (7500 ft combined length) maximum		
Ethernet connection (optional)	10BASE-T 100BASE-TX		
Battery discharge/recharge schedule	Discharge cycle	13.65 VDC - Charging float level. 12.1 VDC - Low Battery Report, if programmed. 10.2 VDC - Minimum operational voltage.	
	Recharge Cycle	AC ON - Battery charging begins and AC Restoral Reports sent. 13.4 V - Battery Restoral Report sent. Battery float charged.	
Environmental	Temperature	0°C to +49°C (+32°F to 122°F)	
	Relative Humidity	5% to 93% at +32°C (+90°F) non-condensing	
Arming stations	B940W, B942/B942W, B930, B921C, B920, B915/B915I, Keyswitch		

Point thresholds (Single EOL resistor circuit style) On-board points 1 to 8	With 1 kΩ resistors	Open - 3.7 to 5.0 VDC Normal - 2.0 to 3.0 VDC Short - 0.0 to 1.3 VDC Short circuit current - 5 mA
	With 2 kΩ resistors	Open - 4.1 to 5.0 VDC Normal - 3.0 to 4.1 VDC Short - 0.0 to 3.0 VDC Short circuit current - 5 mA
	No EOL	Open - 2.6 to 5.0 VDC Short - 0.0 to 2.4 VDC Short circuit current - 5 mA
Point thresholds (Dual EOL on-board points)	Dual EOL (1 kΩ + 1 kΩ)	Short - 0 to 1.67 VDC Open - 4.12 to 4.95 VDC Normal - 1.69 to 2.94 VDC Fault - 2.95 to 4.10 VDC Short circuit current - 5 mA
Compatible enclosures	B10 Medium Control Panel Enclosure, B11 Small Control Panel Enclosure, D2203 Enclosure, D8103 Universal Enclosure, D8108A Attack Resistant Enclosure, D8109 Fire Enclosure	

21.1 Wire requirements

Terminal label	Terminal description	Requirements
18VAC	AC	18 AWG to 12 AWG (1.02 mm to 2 mm)
⊕	Earth ground	16 AWG to 14 AWG (1.5 mm to 1.8 mm)
BAT +	Battery +	Bosch supplied wire lead, included with control panel..
BAT -	Battery -	
OUTPUT A NO	Output A normally open	22 AWG to 12 AWG (0.65 mm to 2 mm)
OUTPUT A C	Output A common	
OUTPUT A NC	Output A normally closed	
COM	Common	
AUX	+ AUX power	
PWR/R	SDI2 power	
A/Y	SDI2 data bus A	
B/G	SDI2 data bus B	
COM/B	SDI2 common	
1	Point 1	
COM	Point 1/2 common	
2	Point 2	
3	Point 3	

COM	Point 3/4 common
4	Point 4
5	Point 5
COM	Point 5/6 common
6	Point 6
7	Point 7
COM	Point 7/8 common
8	Point 8
OUTPUT B	Output B
OUTPUT C	Output C

22 Appendix

This section has information on the following:

- *Address settings, page 132*
- *Reporting and device number information, page 134*
- *AutoIP, page 146*

22.1 Address settings

This section includes address and switch settings for compatible modules.

22.1.1 B208 address settings

The B6512 supports up to 9 B208 Octo-input modules.

The B5512 supports up to 4 modules.

The B4512 supports up to 2 modules.

The B3512 does not support the B208 module.

B208 address number	B6512 point numbers	B5512 point numbers	B4512 point numbers
1	11 - 18	11 - 18	11 - 18
2	21 - 28	21 - 28	21 - 28
3	31 - 38	31 - 38	
4	41 - 48	41 - 48	
5	51 - 58		
6	61 - 68		
7	71 - 78		
8	81 - 88		
9	91 - 96		

22.1.2 B308 address settings

The 65512 supports up to 9 B308 Octo-output modules.

The B5512 supports up to 5 modules.

The B4512 supports up to 3 modules.

The B3512 does not support the B308 module.

B308 address number	B6512 output numbers	B5512 output numbers	B4512 output numbers
1	11 - 18	11 - 18	11 - 18
2	21 - 28	21 - 28	21 - 28
3	31 - 38	31 - 38	31 - 38
4	41 - 48	41 - 48	
5	51 - 58	51 - 58	
5	51 - 58		
6	61 - 68		
7	71 - 78		

B308 address number	B6512 output numbers	B5512 output numbers	B4512 output numbers
8	81 - 88		

22.1.3

B901 address settings

The B6512 supports four B901 Access Control Modules.

Address	Designation
0,0	Disabled
0,1 to 0,4	Doors 1 through 4

22.1.4

B91x address settings

Address	Switches					
	1	2	3	4	5	6
1	ON	OFF	OFF	OFF	OFF	OFF
2	OFF	ON	OFF	OFF	OFF	OFF
3	ON	ON	OFF	OFF	OFF	OFF
4	OFF	OFF	ON	OFF	OFF	OFF
5	ON	OFF	ON	OFF	OFF	OFF
6	OFF	ON	ON	OFF	OFF	OFF
7	ON	ON	ON	OFF	OFF	OFF
8	OFF	OFF	OFF	ON	OFF	OFF
9	ON	OFF	OFF	ON	OFF	OFF
10	OFF	ON	OFF	ON	OFF	OFF
11	ON	ON	OFF	ON	OFF	OFF
12	OFF	OFF	ON	ON	OFF	OFF
13	ON	OFF	ON	ON	OFF	OFF
14	OFF	ON	ON	ON	OFF	OFF
15	ON	ON	ON	ON	OFF	OFF
16	OFF	OFF	OFF	OFF	ON	OFF
17	ON	OFF	OFF	OFF	ON	OFF
18	OFF	ON	OFF	OFF	ON	OFF
19	ON	ON	OFF	OFF	ON	OFF
20	OFF	OFF	ON	OFF	ON	OFF
21	ON	OFF	ON	OFF	ON	OFF
22	OFF	ON	ON	OFF	ON	OFF
23	ON	ON	ON	OFF	ON	OFF

Address	Switches					
	1	2	3	4	5	6
24	OFF	OFF	OFF	ON	ON	OFF
25	ON	OFF	OFF	ON	ON	OFF
26	OFF	ON	OFF	ON	ON	OFF
27	ON	ON	OFF	ON	ON	OFF
28	OFF	OFF	ON	ON	ON	OFF
29	ON	OFF	ON	ON	ON	OFF
30	OFF	ON	ON	ON	ON	OFF
31	ON	ON	ON	ON	ON	OFF
32	OFF	OFF	OFF	OFF	OFF	ON

22.2 Reporting and device number information

This section contains information to help you understand control panel reports.

22.2.1 Report format definitions



Notice!

Control panels using Modem4 send 4-digit Point and User data.

Panel event	Modem4 code D6500 mode	Modem4 code Bosch SIA mode	Contact ID event	Contact ID code
A point supervisory condition occurred	Jspppp	NriaBSpppp	24 hour Non-Burglary	1 150 aa ppp
A valid local RPS or Installer Services Portal programming tool (available in Europe, Middle East, Africa, and China) access occurred	RsF01	NLS	Successful Download/ Access	1 412 00 000
A valid remote RPS or Installer Services Portal programming tool (available in Europe, Middle East, Africa, and China) access callback occurred	RsssF	NphhhRS	Successful Download/ Access	1 412 00 000
A valid remote RPS or Installer Services Portal programming tool (available in Europe, Middle East, Africa, and China) access occurred	RsssF	NRS	Successful Download/ Access	1 412 00 000
AC Fail - mains power supply	Pssss	NAT	AC Loss	1 301 00 000

Panel event	Modem4 code D6500 mode	Modem4 code Bosch SIA mode	Contact ID event	Contact ID code
AC Restore - mains power supply	Rsss0	NAR	AC failure restore	3 301 00 000
Add Key Fob to a User (Assign Card Event)	NsD30	NidiiiiDAiiii	Local Only	Local only
Alarm	Aspppp	NriaBApppp	Burglary	1 130 aa ppp
Alarm Cross Point	Aspppp	NriaBMpppp	Burglary	1 130 aa ppp
Alarm Exit Error	Aspppp	Nria/idiiiiEApppp	Entry/Exit	1 134 aa ppp
Alarm with Recent Closing	Aspppp	Nria/CRpppp	Entry/Exit	1 459 aa uuu
All Points Tested by User	RsssF	NRITC	Local Only	Local Only
All SDI devices are missing, power is shorted	TsssD	NpiET	Expansion Module Failure	1 333 00 000
All SDI devices are restored, power is normal	RsssD	NpiER	Expansion Module Failure Restore	3 333 00 000
An invalid RPS or Installer Services Portal programming tool (available in Europe, Middle East, Africa, and China) remote access callback occurred	TsssF	Np004RU	Unsuccessful Access	1 413 00 000
An invalid RPS or Installer Services Portal programming tool (available in Europe, Middle East, Africa, and China) remote access occurred	TsssF	NRU	Unsuccessful Access	1 413 00 000
Area Watch End	NsD52	Nriia/idiiiiTZ	Local Only	Local Only
Area Watch Start	NsD51	Nriia/idiiiiTW	Local Only	Local Only
Armed PartOn delay	Csiiii	Nriia/idiiiiNL	Armed STAY	3 441 aa uuu
Armed PartOn instant	Csiii	Nriia/idiiiiNL	Armed STAY	3 441 aa uuu
Aux Overload	Tsss9	NYM	Low System Battery	1 302 00 000
Aux Overload Restore	Rsss9	NYR	Low System Battery Restore	3 302 00 000
Battery Charger Circuit Trouble	Tsss9	NYT	System Trouble	1 300 00 000
Battery Charger Circuit Trouble Restoral	Rsss9	NYR	System Trouble Restore	3 300 00 000
Bypass by Sked	Nspppp	Nriia/ aikkkUBpppp	Zone/Sensor Bypass	1 570 aa ppp

Panel event	Modem4 code D6500 mode	Modem4 code Bosch SIA mode	Contact ID event	Contact ID code
Bypass by User	Nspppp	Nriiaa/ idiiiiUBpppp	Zone/Sensor Bypass	1 570 aa ppp
Cellular Fewer than Two Towers	TssssD	NpiddddET	System Peripheral Trouble	1 330 00 zzz
Cellular Fewer than Two Towers Restoral	RssssD	NpiddddER	System Peripheral Trouble Restore	3 330 00 zzz
Cellular Low Signal	TssssD	NpiddddET	System Peripheral Trouble	1 330 00 zzz
Cellular Low Signal Restoral	RssssD	NpiddddER	System Peripheral Trouble Restore	3 330 00 zzz
Cellular No Tower Available	TssssD	NpiddddET	System Peripheral Trouble	1 330 00 zzz
Cellular No Tower Available Restoral	RssssD	NpiddddER	System Peripheral Trouble Restore	3 330 00 zzz
Cellular Service Not Activated	TssssD	NpiddddET	System Peripheral Trouble	1 330 00 zzz
Cellular Service Not Activated Restoral	RssssD	NpiddddER	System Peripheral Trouble Restore	3 330 00 zzz
Change another's password or card	NsDO4	NidiiiiJViiii	Local Only	Local Only
Change own password	NsDO4	NidiiiiJViiii	Local Only	Local Only
Checksum failure on configuration memory	TsD15	NYF	RAM Checksum Bad	1 303 00 000
Closing by Account	Csiiii	NidiiiiCL	O/C by account	3 401 00 uuu
Closing by Area	Csiiii	Nriiaa/idiiiiCL	O/C by User	3 401 aa uuu
Closing Early by Area	Csiiii	Nriiaa/idiiiiCK	Early O/C	3 451 aa uuu
Closing Late by Area	Csiiii	Nriiaa/idiiiiCJ	Late O/C	3 452 aa uuu
Communication failure by route group	TsB01	NrggYC	Failure to communicate event	1 354 00 000
Communication failure by route group restored	NsB01	NrggYK	Failure to communicate event	3 354 00 000
Communication trouble by network	TsB01	NpiddddYS	Communication Trouble	1 350 00 ¹ zzz
Communication trouble by network restored	NsB01	NpiddddYK	Communication Trouble Restore	3 350 00 ¹ zzz
Communication trouble by phone	TsB01	NphhhYS	Communication Trouble	1 350 00 000
Communication trouble by phone restored	NsB01	NphhhYK	Communication Trouble Restore	3 350 00 000

Panel event	Modem4 code D6500 mode	Modem4 code Bosch SIA mode	Contact ID event	Contact ID code
Configuration Failure (Device)	TssssD	NpiddddEP	System Peripheral Trouble	1 330 00 zzz
Configuration Failure Restoral (Device)	RssssD	NpiddddER	System Peripheral Trouble Restoral	3 330 00 zzz
Control panel battery low	Tsss9	NYT	Low System Battery	1 302 00 000
Control panel battery missing	Tsss9	NYM	Battery Missing/Dead	1 311 00 000
Control panel battery restored to normal	Rssss9	NYR	Low System Battery Restore	3 302 00 000
Control panel off-line	TsssF	Nid5002TS	System Shutdown	3 308 00 F02
Control panel on-line	RssssF	Nid5002TE	System Shutdown Restore	3 308 00 F02
Create Status Report	Sssss	NYY	Status Report to Follow	1 605 00 000
Date changed - no user indentified	NsD07	NJD	Time/Date Reset	1 625 00 000
Date changed by user	NsD07	NidiiiiJD	Time/Date Reset	1 625 00 uuu
Delete User by User	NsD05	NidiiiiJXiiii	Local Only	Local Only
DNS Failure	TsB01	NpiddddYS	Communication Trouble	1 350 00 ¹ zzz
DNS Failure Restore	NsB01	NpiddddYK	Communication Trouble Restore	3 350 00 ¹ zzz
Duplicate SDI2 device	TssssD	NpiddddET	System Peripheral Trouble	1 330 aa iii
Duplicate SDI2 device Restore	RssssD	NpiddddER	System Peripheral Trouble Restore	3 330 aa iii
Duress	Diiii	Nriiaa/idiiniiHA	Duress	1 121 aa uuu
Equipment Fail	TsD29	NpiddddIA	System Peripheral Trouble	1 330 00 ¹ zzz
Equipment Restore	RsD29	NpiddddIR	System Peripheral Trouble Restore	3 330 00 ¹ zzz
Event Log Overflow	AsD01	NJO	Event Log Overflow	1 624 00 000
Event Log Threshold has been reached	TsD01	NJL	Event Log 90% Full	1 623 00 000
Extend Close Time by Area	TsD26	Nriiaa/idiinii/ tihhmmCE	Auto-arm Time Extended	1 464 aa uuu
Extra Point	Tpppp	NriiaaXEpppp	Maintenance Alert	1 393 aa ppp
Fail To Close by Area	TssssE	NriaCI	Failed to Close	1 454 aa 000
Fail to Open by Area	TssssE	NriaOI	Failed to Open	1 453 aa 000
Fire Alarm	Fspppp	NriiaaFApppp	Fire	1 110 aa ppp
Fire Cancel	\iiii	Nriiaa/idiiniiFC	Cancel	1 406 aa uuu

Panel event	Modem4 code D6500 mode	Modem4 code Bosch SIA mode	Contact ID event	Contact ID code
Fire Drill Start	TsssF	Nriaa/idiiiiFL	Fire Test Start	1 604 aa iii
Fire Drill End	RsssF	Nriaa/idiiiiNF	Fire Test End	3 604 aa iii
Fire Missing	Mpppp	NriaaFYpppp	Fire Trouble	1 373 aa ppp
Fire Restoral from Alarm	Hspppp	NriaaFHpppp	Fire Alarm Restore	3 110 aa ppp
Fire Restoral from Trouble	Hspppp	NriaaFJpppp	Fire Trouble Restore	3 373 aa ppp
Fire Supervision	Espppp	NriaaFSpppp	Fire Supervisory	1 200 aa ppp
Fire Supervision from Restore	Espppp	NriaaFVpppp	Fire Supervisory Restore	3 200 aa ppp
Fire Trouble	Gspppp	NriaaFTpppp	Fire Trouble	1 373 aa ppp
Fire Walk Test End	RsssF	Nriaa/idiiiiFK	Fire Test End	3 604 aa uuu
Fire Walk Test Start	TsssF	Nriaa/idiiiiFI	Fire Test Start	1 604 aa uuu
Forced Armed PartOn Delay	Csiii	Nriaa/idiiiiNF	Partial Arm	3 456 aa uuu
Forced Armed PartOn Instant	Csiii	Nriaa/idiiiiNF	Partial Arm	3 456 aa uuu
Forced Close Early by Area	Csiii	Nriaa/idiiiiCF	Early O/C	3 451 aa uuu
Forced Close Late by Area	Csiii	Nriaa/idiiiiCF	Late O/C	3 452 aa uuu
Forced Closing by Area	Csiii	Nriaa/idiiiiCF	O/C by User	3 401 aa uuu
Forced Point	Tspppp	NriaaXWpppp	Zone/Sensor Bypass	1 570 aa ppp
Gas Alarm	Apppp	NriaaGApppp	Gas Detected	1 151 aa ppp
Gas Alarm Restore	Rpppp	NriaaGHpppp	Gas Detected Restore	3 151 aa ppp
Gas Cancel	\jiii	Nriaa/idiiiiGC	Cancel	1 406 aa iii
Gas Missing	Vpppp	NriaaUZpppp	Sensor Trouble	1 380 aa ppp
Gas Supervisory	Jpppp	NriaaGSpppp	Sensor Trouble	1 380 aa ppp
Gas Supervisory Restore	Rpppp	NriaaGJpppp	Sensor Trouble Restore	3 380 aa ppp
Gas Trouble	Tpppp	NriaaGTpppp	Sensor Trouble	1 380 aa ppp
Gas Trouble Restore	Rpppp	NriaaGJpppp	Sensor Trouble Restore	3 380 aa ppp
Ground Fault	Tspppp	NriaaBTpppp	Ground Fault	1 310 01 000
Invalid Key Fob	VsD10	NidiiiiUY	Latch-Key Supervision	1 642 00 iii
Invalid Key Fob Restoral	RsD10	NidiiiiUR	Latch-Key Supervision Restore	3 642 00 iii
Invalid local access detected	TsF01	NLU	Unsuccessful access	1 413 00 000
Invalid Point Transmitter	Vpppp	NriaaUYpppp	Loss of Supervision -RPM	1 382 aa ppp
Invalid Point Transmitter Restore	Rpppp	NriaaBRpppp	Loss of Supervision -RPM Restore	3 382 aa ppp
Invalid Popit Address	Vpppp	NriaaUYpppp	Loss of Supervision - RPM	1 382 aa ppp

Panel event	Modem4 code D6500 mode	Modem4 code Bosch SIA mode	Contact ID event	Contact ID code
Invalid Popit Address Restore	Rpppp	NriaaBRpppp	Loss of Supervision - RPM Restore	3 382 aa ppp
IP Address Error	TsssD	NpiddddET	System Peripheral Trouble	1 330 00 ¹ zzz
IP Address Error	RsssD	NpiddddER	System Peripheral Trouble Restore	3 330 00 ¹ zzz
Key fob Missing	VsD10	NidiiiiUY	Latch-Key Supervision	1 642 00 iii
Key fob Missing Restoral	RsD10	NidiiiiUR	Latch-Key Supervision Rest.	3 642 00 iii
Key fob Panic	Assss	NidiiiiPA	Duress Alarm	1 121 00 iii
Key fob Silent (Hold Up) Alarm	Dssss	NidiiiiHA	Duress Alarm	1 121 00 iii
Keypad Panic Alarm	Apppp	Nriaa/Papppp	Panic Alarm	1 120 aa ppp
Keypad Silent (Hold-Up) Alarm	Dpppp	Nriaa/Happpp	Silent Alarm	1 122 aa ppp
Medical Alarm	Apppp	Nriaa/Mapppp	Personal Emergency	1 101 aa ppp
Missing Alarm	Mpppp	NriaaUZpppp	General Alarm	1 140 aa ppp
Missing Fire Supervision	GMpppp	NriaaFZpppp	Fire Trouble	1 373 aa ppp
Missing Gas Supervision	Vpppp	NriaaGSpppp	Sensor Trouble	1 380 aa ppp
Missing Supervision	MTpppp	NriaaBZpppp	Loss of Supervision -RPM	1 382 aa ppp
Missing Trouble	Vpppp	NriaaUYpppp	Loss of Supervision - RPM	1 382 aa ppp
Network Cable Connected	NsD43	NpiddddNR010	System Peripheral Trouble Restore	3 330 00 zzz
Network Cable Disconnected	NsD42	NpiddddNT010	System Peripheral Trouble	1 330 00 zzz
Non-Fire Cancel Alarm	\siiii	Nriaa/idiiiiBC	Cancel	1 406 aa uuu
Normal start-up of the control panel	NsD14	NRR	System Reset	1 305 00 000
Opening by Account	Osiiii	NidiiiiOP	O/C by account	1 401 00 uuu
Opening by Area	Osiiii	Nriaa/idiiiiOP	O/C by user	1 401 aa uuu
Opening Early by Area	Osiiii	Nriaa/idiiiiOK	Early O/C	1 451 aa uuu
Opening Late by Area	Osiiii	Nriaa/idiiiiOJ	Late O/C	1 452 aa uuu
Parameters changed	NsD02	NYG	Panel Programming Changed	1 306 00 000
Personal Notification Communication Trouble	TsB01	NpiddddYS	Communication Trouble	1 350 0 zzz

Panel event	Modem4 code D6500 mode	Modem4 code Bosch SIA mode	Contact ID event	Contact ID code
Personal Notification Communication Trouble Restore	NsB01	NpiddddYK	Communication Trouble Restore	3 350 0 zzz
Phone Line Missing 1	TsssB	NLT1	Telco 1 Fault	1 351 00 000
Phone Line Restored 1	RsssB	NLR1	Telco 1 Fault Restore	3 351 00 000
Popex Bus Fault	TsssD	NYI	PS Over Current	1 312 00 ZZZ
Popex Bus Fault Restore	RsssD	NYJ	PS Over Current Restore	3 312 00 ZZZ
Popex Invalid Popit	TsssD	NYI	PS Over Current	1 312 00 ZZZ
Popex Invalid Popit Restore	RsssD	NYJ	PS Over Current Restore	3 312 00 ZZZ
Popex Low Voltage	TsssD	NYI	PS Over Current	1 312 00 ZZZ
Popex Low Voltage Restore	RsssD	NYJ	PS Over Current Restore	3 312 00 ZZZ
Programming Started	TsssF	NiduuuuTS	System Shutdown	1 308 00 iii
Programming Finished	RsssF	NiduuuuTE	System Shutdown Restore	3 308 00 iii
RAM Fail with RPS or Installer Services Portal programming tool (available in Europe, Middle East, Africa, and China)	TsF02	NRA	Unsuccessful access	1 413 00 000
Re-Boot	NsD14t	NRR	System Reset	1 305 00 000
Relay Reset by Sked	NsD20	NaikkkROrrrr	Sounder/Relay Reset	3 320 00 000
Relay Reset by User	NsD18	NidiiiiROrrrr	Sounder/Relay Reset	3 320 00 000
Relay Set by Sked	NsD19	NaikkkRCrrrr	Sounder/Relay Set	1 320 00 000
Relay Set by User	NsD28	NidiiiiRCrrrr	Sounder/Relay Set	1 320 00 000
Remote Reset - System was reset by RPS or Installer Services Portal programming tool (available in Europe, Middle East, Africa, and China)	NsD11	NRN	System Reset	1 305 00 000
Remove User's Key Fob (Assign Card Event)	NsD30	NidiiiiDAuuuu	Local Only	Local Only
Replace Sensor	Tpppp	NriaaBTpppp	Maintenance Alert	1 393 aa ppp
Replace Sensor Restore	Rpppp	NriaaBRpppp	Maintenance Alert Restore	3 393 aa ppp
Replace User's Key Fob (Assign Card Event)	NsD30	NidiiiiDAuuuu	Local Only	Local Only
Restoral	Rpppp	NriaaBRpppp	Sensor Trouble Restore	3 380 aa ppp

Panel event	Modem4 code D6500 mode	Modem4 code Bosch SIA mode	Contact ID event	Contact ID code
Restoral from Alarm	Rpppp	NriaaBHpppp	Burglary Restore	3 130 aa ppp
Restoral from Ground Fault	Rspppp	NriaaBRpppp	Ground Fault Restore	3 310 01 000
RF Interference	TsD08	NpiddddXQ	RF RCVR Jam	1 344 00 ¹ zzz
RF Interference Restore	RsD08	NpiddddXH	RF RCVR Jam Restore	3 344 00 ¹ zzz
RF Transmitter	Hss001	NriaaFRpppp	Maintenance Alert Restore	3 393 aa ppp
RF Transmitter Low Battery	Tspppp	NriaaXTpppp	RF Low Battery	1 384 aa ppp
RF Transmitter Low Battery (Key Fob)	TsD10	NidiiiiXT	Battery Test Failure	1 309 00 uuu
RF Transmitter Low Battery (Key Fob) Restore	RsD10	NidiiiiXR	Battery Test Restore	3 309 00 uuu
RF Transmitter Low Battery Restore	Rspppp	NriaaXRpppp	RF Low Battery	3 384 aa ppp
RF Transmitter Maintenance	Gss001	NriaaFTpppp	Maintenance Alert	1 393 aa ppp
ROM Checksum Fail	AsD12	NYX	ROM Checksum bad	1 304 00 000
SDI Device AC Fail	TsssDt	NpiddddEP	Exp. Module AC Loss	1 342 00 ¹ zzz
SDI Device AC Fail Restore	RsssDt	NpiddddEQ	Exp. Module AC Restore	3 342 00 ¹ zzz
SDI device is missing	TssssD	NpiddddET	Expansion Module Failure	1 333 00 000
SDI device is restored	RssssD	NpiddddER	Expansion Module Failure Restore	3 333 00 000
SDI Device Low Battery	TsssDt	NpiddddEBbb	Exp. Module Low Batt.	1 338 00 ¹ zzz
SDI Device Low Battery Restore	RsssDt	NpiddddEVbb	Exp. Module Batt. Restore	3 338 00 ¹ zzz
SDI Device Missing	TsssDt	NpiddddEM	Exp. Module Failure	1 333 00 ¹ zzz
SDI Device Missing Battery	TsssDt	NpiddddEBbb	Exp. Module Low Batt. Restore	3 338 00 ¹ zzz
SDI Device Missing Battery Restore	RsssDt	NpiddddEVbb	Exp. Module Low Batt. Restore	3 338 00 ¹ zzz
SDI Device Missing Restore	RsssDt	NpiddddEN	Exp. Module Failure Restore	3 333 00 ¹ zzz
SDI Device Over Current	TsssD	NYI	PS Over Current	1 312 00 ¹ zzz
SDI Device Over Current Restore	RsssD	NYJ	PS Over Current Restore	3 312 00 ¹ zzz
SDI Device Tamper	TsssD	NES	Exp. Module Tamper	1 341 00 ¹ zzz
SDI Device Tamper Restore	TsssD	NES	Exp. Module Tamper Restore	3 341 00 ¹ zzz

Panel event	Modem4 code D6500 mode	Modem4 code Bosch SIA mode	Contact ID event	Contact ID code
SDI Device Trouble	TsssD	NET	System Peripheral Trouble	1 330 00 1zzz
SDI Device Trouble Restore	RsssD	NER	System Peripheral Trouble Restore	3 330 00 1zzz
SDI2 device is missing	TsssD	NpiddddEM	Expansion Module Failure	1 333 00 000
SDI2 device is restored from missing	RsssD	NpiddddEN	Expansion Module Failure	3 333 00 000
SDI2 Open Trouble	TsssD	NpiiddddET	Expansion Module Failure	1 333 00 1zzz
SDI2 Open Trouble Restoral	RsssD	NpiddddER	Expansion Module Failure Restore	3 333 00 1zzz
Sensor Reset	NsD27	Nriaa/idiiiiXlrrrr	Sounder/Relay Reset	3 320 00 000
Service Bypass	Nppppp	NriaaUBppppp	Service Request	1 616 aa ppp
Service Bypass Cancel	RBppppp	NriaaUUppppp	Service Request Restore	3 616 aa ppp
Service Smoke Detector	Tppppp	NriaaASppppp	Maintenance Alert	1 393 aa ppp
Service Smoke Detector Restore	Rppppp	NriaaANppppp	Maintenance Alert Restore	3 393 aa ppp
Service Walk Test End	RsssF	NidiiiiTE	Service On/Off Premises	3 466 aa uuu
Service Walk Test Start	TsssF	Nriaa/idiiiiTS	Service On/Off Premises	1 466 aa uuu
Sked Changed - No User Identified	NsD06	NaikkkJS	Schedule Change	1 630 00 000
Sked Changed by User	NsD06	Nidiiii/aikkkJS	Schedule Change	1 630 00 000
Sked has Executed	NsD25	NaikkkJR	Local Only	Local Only
Status: Burg Alarm	SAppppp	OriaaBAppppp	NA	NA
Status: Burg Supervisory	STppppp	OriaaBSppppp	NA	NA
Status: Burg Trouble	STppppp	OriaaBTppppp	NA	NA
Status: Close by Area	SCssss	OriaCL	NA	NA
Status: Fire Alarm	SFppppp	OriaaFAppppp	NA	NA
Status: Fire Supervisory	SEppppp	OriaaFSppppp	NA	NA
Status: Fire Trouble	SGppppp	OriaaFTppppp	NA	NA
Status: Gas Alarm	SAppppp	NriaaGAppp	NA	NA
Status: Gas Supervisory	SJppppp	NriaaGSppp	NA	NA
Status: Gas Trouble	STppppp	NriaaGTppp	NA	NA
Status: Open by Area	SOssss	OriaOP	NA	NA
Swinger Bypass	Nspppp	NriaaUBppppp	Swinger Bypass	1 575 aa ppp

Panel event	Modem4 code D6500 mode	Modem4 code Bosch SIA mode	Contact ID event	Contact ID code
Test Report - System Normal, Expanded Status	RsssE	NRP & see D6600 CIM for Status Items	Periodic Test Report	1 602 00 000
Test Report - System Normal, Non-expanded Status	RsssE	NRP	Periodic Test Report	1 602 00 000
Test Report - System Off-normal, Expanded Status	RsssE	NRV & see D6600 CIM for Status Items	Periodic Test - System Trouble Present	1 608 00 000
Test Report - System Off-normal, Non-expanded Status	RsssE	NRV	Periodic Test - System Trouble Present	1 608 00 000
Time Changed - No User Identified	NsD07	NJT	Time/Date Reset	1 625 00 000
Time Changed by Receiver Sync	NsD07	Nid5001JT	Time/Date Reset	1 625 00 F01
Time Changed by User	NsD07	NidiiiiJT	Time/Date Reset	1 625 00 uuu
Trouble	Tspppp	NriaaBTpppp	Sensor Trouble	1 380 aa ppp
Unverified Event	Kpppp	NriaaUGpppp	Cross-Zone Trouble	1 378 aa ppp
User Authority level has changed	NsD40	NidiiiiJZiiii	Local Only	Local Only
User Passcode Tamper - Too Many Attempts	NsD03	NriaJA	Wrong Code Entry	1 461 aa 000
Walk Test End	RsssF	Nriaa/idiiiiTE	Walk Test Mode Emd	3 607 aa uuu
Walk Test Start	TsssF	Nriaa/idiiiiTS	Walk Test Mode	1 607 aa uuu
Watchdog Reset	NsD09	NpiddddYW	System Reset	1 305 00 000
Watchdog Reset - SDI Device Reported identifies the Source	NsD09	NpiddddYW	System Reset	1 305 00 000

¹zzz represents an SDI, or SDI2 device address value, or network trouble condition, indicated by a number (for example, 501).

22.2.2 SDI2 address information



Notice!

All point numbers, user ID's, output numbers, and device identifier numbers are formatted as 4-digit numbers (right justified with zeros) when transmitted from the control panel in Modem4 format.

SDI2 address	zzz data values	Description
01-08	001-008	SDI2 Keypad 1 through 8

SDI2 address	zzz data values	Description
01-04	201-204	SDI2 Octo-input Modules 1 through 4
01-05	301-305	SDI2 Octo-output Modules 1 through 5
1	801	SDI2 Premises RF Module
N/A	851-858	SDI2 RF Repeater 1 through 8
1	401	SDI2 Network Module 1
01-04	501-504	SDI2 Power Supply Module 1 through 8
01-08	901-916	SDI2 Keypads 1 through 16
1	411, 421, 431, 441	Routes 1 through 4 on SDI2 Network Module 1
99	499	DNS lookup error of RPS hostname
N/A	100	On-board Control Panel Enclosure Tamper
N/A	400	On-board Ethernet
N/A	408-409	On-board Plug-in Modules 1 through 2

22.2.3 Device numbers (zzz, dddd)

Bus	Keypad display #	Reporting number	Description
OnBrd	100	100	Control Panel Enclosure
OnBrd	400	400	On-board Ethernet module
OnBrd	408	408	Plug-in Module
SDI2	2 – 25	201 – 224	Octo-Input Modules 1 through 24
SDI2	66 – 77	301 – 312	Octo-Output Modules 1 through 12
SDI2	151	801	Premises RF Module
SDI2	161 – 168	851 – 858	RF Repeaters 1 through 8
SDI2	173	401	Network Module 1
SDI2	174	402	Network Module 2
SDI2	176 - 183	501 – 508	Power Supply Modules 1 through 8
SDI2	200 - 216	901 – 916	Keypads 1 through 16

22.2.4 Communication Trouble device numbers (zzzz)

Bus	Keypad display #	Reporting number	Description
On Board	Dest [1-4] Onbrd IP	410, 420, 430, 440	Destinations 1 through 4 via On-board Ethernet
On Board	Dest [1-4] Cell# [1-2]	418, 428, 438, 448	Destinations 1 through 4 via On-board Cellular Module
On-Board	PN Dest [1 – 16]	451 – 466	Personal notification destinations number 1 through 16

SDI2	Dest [1-4] SDI2# 1	411, 421, 431, 441	Destinations 1 through 4 on SDI2 Network Module 1
SDI2	Dest [1-4] SDI2# 2	412, 422, 432, 442	Destinations 1 through 4 on SDI2 Network Module 2
any	RPS or Installer Services Portal programming tool (available in Europe, Middle East, Africa, and China)	499	Used for DNS lookup error of RPS hostname

22.2.5 Special User IDs (uuuu, iiiii)

To better identify the originator of some control panel events with no unique, Standard User identified, special user IDs designate each special case. All user ID are defined in the table below.

User ID type	Keypad display	Contact ID reporting	Modem format	User text
Service User	0	F00	0	“SERVICE USER”
Standard Users	1...50	001...50	1...50	{configured text}
Time Sync	5001	F01	5001	“AUTO TIME SYNC”
RPS or Installer Services Portal programming tool (available in Europe, Middle East, Africa, and China) User	5002	F02	5002/none	“BY RPS”
Automation User	5003	F03	5003/none	“BY AUTOMATION”
Keyswitch	5004	F04	5004	“BY KEYSWITCH”
No User Specified	User not displayed	000	0xFFFF (displays blank)	{no text}

22.2.6 Keypad alarm virtual point numbers (ppp, pppp)

Special point numbers identify the originator of manually created keypad alarm events. All special point numbers are defined in the table below.



Notice!

The point numbers for manually created keypad alarm events are changed in control panel firmware version 3.01.

Originating keypad	Control panel firmware version 2.04 and lower, reported point number	Control panel firmware version 3.01 and higher, reported point number
Keypad 1	330	901

Keypad 2	340	902
Keypad 3	350	903
Keypad 4	360	904
Keypad 5	370	905
Keypad 6	380	906
Keypad 7	390	907
Keypad 8	400	908

22.3

AutoIP

You can use AutoIP when you enable AutoIP on the computer on which you operate RPS or the Installer Services Portal programming tool (available in Europe, Middle East, Africa, and China).

Using AutoIP

1. On the computer, enable AutoIP.
2. Remove power from the control panel.
3. Connect an Ethernet cable to the Ethernet port on the computer.
4. Connect the Ethernet cable to the Ethernet port on the control panel.
5. Apply power to the control panel.
6. Wait 2 minutes.

Notice!

IP address 169.254.1.1 only

The RPS or Installer Services Portal programming tool IP Direct connection option only uses 169.254.1.1 to connect. RPS or Installer Services Portal programming tool does not allow you to set the option.



If the RPS or Installer Services Portal programming tool connection fails, the control panel did not take the correct IP address.

Checking the IP address of the control panel

1. From a keypad, open from the Installer menu.
2. Enter the installer passcode, and then open the [1] **Installer Menu**.
3. Go to [1] **Programming Menu** > [2] **Network** > [1] **Ethernet** > (choose the bus module or on-board) > [1] **Module Parameters** > [2] **Address Parameters** > [1] **IP Address**.

If the control panel address is not 169.254.1.1, troubleshoot the issue.

Troubleshooting AutoIP

- If the control panel also uses the Ethernet for IP communication, make sure you cycled power to the control panel. When power cycles, the control panel clears the IP address assigned by the network and adopts the AutoIP address assigned by the RPS or Installer Services Portal programming tool computer.
- Make sure that no other device is connected to the RPS or Installer Services Portal programming tool computer using Ethernet. The computer assigns 169.254.1.1 to the first connected device.
- Apply a new registry key to the computer to enable AutoIP. Make sure that you have permission from your company IT department before changing the registry.

Adding a new registry key, if required

1. Open Notepad.

2. Copy and paste or type the text shown below the instructions.
3. Save the file as AutoIP.reg to a location on the RPS or Installer Services Portal programming tool computer that you can easily find.
4. Use Windows Explorer to find the saved file. Double-click the file to add it to the computer registry.
5. Restart the RPS or Installer Services Portal programming tool computer.

Text for the AutoIP.reg file:

Windows Registry Editor Version 5.00

[HKEY_LOCAL_MACHINE\SYSTEM\CurrentControlSet\Services\Tcpip\Parameters]

"IPAutoconfigurationEnabled"=dword:00000001



Bosch Security Systems B.V.

Torenallee 49
5617 BA Eindhoven
Netherlands

www.boschsecurity.com

© Bosch Security Systems B.V., 2020