

SIEMENS

Fire Alarm Control Panel Model FC901-U3/FC901-R3

Installation, Operation and Maintenance Manual

Building Technologies Division

TABLE OF CONTENTS

- INTRODUCTION** 1
- CONTROL PANEL LIMITATIONS** 1
- PREFACE** 2
- DESCRIPTIONS**..... 4
- FC901 SYSTEM DESCRIPTION** 4
- Power Supply* 4
- Signaling Line Circuit (SLC)* 4
- Notification Appliance Circuits*..... 5
- Status Relays* 5
- Programming Port* 5
- DACT*..... 5
- OPTIONAL MODULES**..... 5
- City Tie Module (FCI2020-U1)* 5
- Battery Sets*..... 5
- SLC ADDRESSABLE DEVICES** 6
- Smoke Detector*..... 6
- Heat Detectors*..... 6
- Addressable Modules (Monitor and Control)*..... 6
- Manual Stations*..... 6
- Programming SLC Devices* 6
- EVENT HISTORY** 7
- GENERAL DESIGN FEATURES** 8
- Environmental*..... 8
- Power Limiting*..... 8
- Ground Fault Detection* 8
- NAC Operation* 8
- Security Features* 8
- REGULATORY STANDARDS** 9
- Underwriters Laboratories* 9
- Federal Communications Commission*..... 9
- GENERAL SPECIFICATIONS** 10
- Environmental*..... 10
- Primary Power Supply*..... 10
- Secondary Power Supply* 10
- Auxiliary Power Outputs* 10
- Status Relays* 11
- Notification Appliance Circuits*..... 11
- SLC Addressable Device Circuits* 11
- City Tie Circuits* 11
- DACT Circuits*..... 12
- CONTROL PANEL OPERATION** 13
- OPERATION INSTRUCTIONS**..... 13
- Standby Condition* 13
- Alarm Conditions* 13
- Trouble Conditions* 14
- Supervisory Conditions* 14
- ADDITIONAL OPERATING PROCEDURES** 16
- Lamp Test*..... 16
- History* 16
- FC901 OPERATING INSTRUCTIONS** 17
- Alarm Operation* 17
- Authorized Personnel Only*..... 17
- Trouble Operation*..... 17

Event Scrolling.....	17
Fuse Replacement and Battery Maintenance	17
CONTROL PANEL INSTALLATION	18
PARTS SUPPLIED – FC901	19
1. FC901 Enclosure Package.....	19
2. FC901 Main Board Package	19
3. FC901 Configuration Kit Package.....	21
CAUTIONS.....	22
CONTROL PANEL LOCATION	22
INSTALLATION	22
Enclosure Mounting.....	22
Remove Knock-Outs	25
Power Supply Mounting	26
Ground Wire Installation.....	27
Battery Installation.....	28
Optional City Tie Mounting	29
Main Board Assembly Installation	30
Earth Cable Installation	30
SYSTEM WIRING.....	31
AC Connection	31
Battery Connection.....	31
WIRING	31
Control Panel Wiring Overview	32
Wiring Entering Enclosure.....	32
Install Wiring.....	32
Wiring Separation.....	33
Internal Structure	34
Power Supply and Battery Wiring.....	35
Status Relays	36
Auxiliary Power Outputs Wiring.....	36
NAC Wiring.....	37
SLC Addressable Device Circuit	38
SLC Addressable Device Wiring Diagrams.....	41
Optional City Tie/Leased Line	43
DACT Wiring.....	43
PROGRAMMING THE CONTROL PANEL	44
KEYPAD PROGRAMMING	44
PC PROGRAMMING	44
PROGRAMMING SECURITY	44
MAINTENANCE	45
GENERAL.....	45
QUICK TEST.....	46
APPENDIX-A: REFERENCE DATA	48
WIRE SELECTION GUIDES.....	48
Resistance of Solid Copper Wire	48
Addressable Device Circuit Wire Selection Guide	48
BATTERY SIZE CALCULATIONS	49
Total System Currents.....	49
Battery Size	49
APPENDIX-B: COMPATIBLE DEVICES.....	50
DEVICES FOR ADDRESSABLE DEVICE CIRCUITS.....	50
Siemens SLC Manual Pull Stations.....	50
Siemens SLC Modules.....	50
Siemens SLC Detectors	51
Siemens SLC Bases	50
Siemens SLC Accessories (ILED-HC, -HW don't match from compatibility list)	50
FD182UL	51

<i>DEVICES FOR NOTIFICATION APPLIANCE CIRCUITS</i>	52
APPENDIX-C: TROUBLESHOOTING	53
<i>A. General</i>	53
<i>B. System Events</i>	54
APPENDIX-D: ALARM VERIFICATION	55
APPENDIX-E: APPLICATION SPECIFIC DETECTION	56
APPENDIX-F: TESTING/MAINTENANCE	57
APPENDIX-G: LCD, CONTROLS AND INDICATORS	58
<i>Communication Port Connector</i>	58
<i>LEDS, Buzzer and Dedicated Push Buttons</i>	58
<i>LCD Display</i>	61
APPENDIX-H: OUTPUT FEATURES	62
<i>Output Activation- and Deactivation- Delays</i>	62
APPENDIX-I: PAS / PRE-SIGNAL	63
<i>PAS</i>	63
<i>Pre-Signal</i>	64
APPENDIX-J: DACT INFORMATION OVERVIEW	65
APPENDIX-K: GLOSSARY	70

INTRODUCTION

CONTROL PANEL LIMITATIONS

This control panel may not show an alarm condition without compatible initiating devices (smoke detectors, etc.) and notification devices (horn, strobes, etc.) connected to it. Electrical ratings of the initiation and notification appliances must be compatible with the electrical ratings of the control panel and must be properly interconnected. The wiring used for interconnection must be large enough to carry the total current for all appliances without excessive voltage drop.

The control panel must be connected to a dedicated primary electrical source that has a high degree of reliability and adequate capacity for this control panel. The only means of disconnecting this power source shall be available only to authorized personnel and clearly marked "Fire Alarm Circuit Control".

The control panel must also have connected to it a battery set (24V) that has enough capacity to properly operate the system for 24 hours standby and 5 minutes alarm per UL864 9th (section 63.2.3 and 63.2.5) . These batteries do lose capacity with age. Batteries must be replaced when they fail to provide the control panel with the required standby and alarm power or after 4 years, whichever happens first. These batteries must be checked for performance at least two (2) times a year or more often if local requirements dictate.

Even though this control panel was made to last for the expected life of the fire alarm system, any part could fail at any time. Therefore a regular test program should be followed and documented to make sure that each part of the system is tested as in Chapter 7 of NFPA 72 or more often if dictated by local code requirements. Malfunctioning units must be replaced or repaired immediately by factory authorized service personnel.



This control panel is designed to show an alarm condition when the initiating devices connected to it detect specific conditions. These conditions may or may not represent a life-threatening condition. Also, evacuation of a building or area unnecessarily may subject individuals to an unnecessary hazard. Therefore, it is most important that the building owner, manager, or representative promulgate, distribute, and/or post instructions describing steps to be taken when the fire alarm control panel signals an alarm condition. These instructions should be developed in cooperation and conformance with representatives of the local authority having jurisdiction.

As a precautionary measure, it is strongly suggested that one of these steps should be to notify the local fire department of an abnormal condition even where the DACT option (or similar device) is included in the system.

NOTICE TO USERS, INSTALLERS, AUTHORITIES HAVING JURISDICTION, AND OTHER INVOLVED PARTIES		
This product incorporates field-programmable software. In order for the product to comply with the requirements in the Standard for Control Units and Accessories for Fire Alarm Systems, UL 864, certain programming features or options must be limited to specific values or not used at all as indicated below.		
Program Feature or Option	Possible Settings	Settings Permitted in UL 864
Supervision/Trouble Resound	Not enabled 0-30 hours	Yes 1-24 hours

PREFACE

Along with the use of this instruction manual, the appropriate following standards and the manufacturer's instructions for initiating and notification devices should be used to install and maintain a functioning fire alarm signaling system.

NFPA 72 National Fire Alarm Code

For other standards that may apply contact the authority having jurisdiction.

For NFPA publications, contact:

National Fire Protection Association
Batterymarch Park
Quincy, Massachusetts 02269

FCC PART 68 WARNING

1. This equipment complies with Part 68 of the FCC rules and the requirements adopted by the ACTA. On bottom of this equipment is a label that contains, among other information, a product identifier of [US:02XAL00BFCM901]. If requested, this number must be provided to the telephone company.
2. If this equipment FC901 causes harm to the telephone network, the telephone company will notify you in advance that temporary discontinuance of service may be required. But if advance notice isn't practical, the telephone company will notify the customer as soon as possible. Also, you will be advised of your right to file a complaint with the FCC if you believe it is necessary.
3. The telephone company may make changes in this facilities, equipment, operations or procedures that could affect the operation of the equipment. If this happens the telephone company will provide advance notice in order for you to make necessary modification to maintain uninterrupted service.
4. If you experience trouble with this equipment, you disconnect it from the network until the problem has been corrected or until you are sure that the equipment is not malfunctioning.
5. Please follow instructions for repairing if any (e.g. battery replacement section); otherwise do not alternate or repair any parts of device except specified.
6. Connection to party line service is subject to state tariffs. Contact the state public utility commission public service commission or corporation commission for information.
7. If the telephone company requests information on what equipment is connected to their lines, inform them of:
 - a) The telephone number that this unit is connected to,

b) The ringer equivalence number [0.0B]

c) The USOC jack required [RJ11C], and

d) The FCC Registration Number [US:02XAL00BFCM901]

Items (b) and (d) are indicated on the label. The ringer equivalence number (REN) is used to determine how many devices can be connected to your telephone line. In most areas, the sum of the RENs of all devices on any one line should not exceed five (5.0). If too many devices are attached, they may not ring properly.

Service Requirements

In the event of equipment malfunction, all repairs should be performed by our Company or an authorized agent. It is the responsibility of users requiring service to report the need for service to our Company or to one of our authorized agents. Service can be facilitated through our office at:

SIEMENS INDUSTRY, INC. – BUILDING TECHNOLOGIES DIVISION – FIRE SAFETY
8 FERNWOOD RD., FLORHAM PARK, NJ 07932
+1 973 593 6582

DESCRIPTIONS

FC901 SYSTEM DESCRIPTION

The FC901 is a compact but powerful standalone fire alarm control panel. It features advanced addressable fire detection, keypad and offline programming, notification circuits, a 160 by 64 dots LCD display and event history retention capability. Its typical configuration includes a power supply, a signaling addressable device circuit, two notification appliance circuits (NAC), Digital Alarm Communication Transmitter (DACT), four system status relays and a USB programming port.

All the components of the FC901 control panel are mounted in an 18.1" x 16.5" enclosure. The FC901 has only one electronic main board which integrates most functional parts together (the CPU board is mounted to main board before delivery), including DACT, System Display, signaling line circuit, NAC, serial interface circuits, system status relays, programming port and battery charging circuit. The main board is mounted on the supporting frame, and it provides the connections for external field wiring. An optional city tie module can be mounted on the backside of the main board. The power supply is located under the main board and supporting frame.

The FC901 features one LCD screen which is used to indicate the specific indications for system events while LEDs indicate general panel status.

FC901 supports surface mounting and semi-flush mounting. Semi-flush mounting kits are available for the enclosure.

System status information is provided by a 160 by 64 dots, backlit LCD and by discrete LED indicators for major control panel functions.

The LCD is used to display event data, including alarms and troubles conditions, zone or device custom identification of messages, and a log of the system event history. A back light is included in the display to assure visibility in low light. To conserve power, the back light is only activated during a reported event or on operation of a display control button.

Individual LEDs on the panel are provided to indicate ALARM, SUPERVISORY, TROUBLE, NAC SILENCED, AUDIBLES ON, SYSTEM GROUND FAULT and SYSTEM POWER. Direct push-button controls are provided for SILENCE, UNSILENCE, ACKNOWLEDGE, MENU, OK, CANCEL, RESET and a four-way button for menu navigation.

Power Supply

A 26V (nominal) power supply provides all operating power to the control panel for both standby and alarm conditions. Sufficient battery charging capability is available to charge 12-18 AH sealed lead-acid batteries within code requirements for up to 24 hours of normal standby operation plus 5 minutes of alarm operation. The battery will be automatically disconnected at low battery voltage to prevent deep discharge and battery damage.

Signaling Line Circuit (SLC)

The FC901 fire alarm control panel provides a signaling line circuit with the capacity of 50 addressable devices.

Notification Appliance Circuits

The FC901 control panel has two independent notification appliance circuit (NACs). It can be configured as two Class B (Style Y) NACs or one Class A (Style Z) NAC. Each circuit can be selected to give continuous output or one of five sounding patterns. There is also a system coder capable of zone operation. All of the NACs are power limited and support synchronization of listed devices using the Siemens sync protocol.

Serial Interface Circuit

The FC901 control panel has a Serial Interface Circuit that will drive up to 8 remote LCD annunciators.

Status Relays

Four relays with dry contacts are provided. Three relays are dedicated to alarm, supervisory, and trouble conditions on the panel. The remaining relay is programmable. The relay contacts are Form C and are rated for 2A@30VDC resistive.

Programming Port

A USB standard type B plug is provided for temporary connection to a computer for panel programming and firmware download when using the FX901-U2 System Configuration Tool.

DACT

The Digital Alarm Communication Transmitter (DACT) is integrated on the FC901 main board and it will send control panel status information to a central or remote receiving station through the Public Switched Telephone Network (PSTN).

OPTIONAL MODULES

City Tie Module (FCI2020-U1)

The city tie module provides local energy and polarity reversal connections. The polarity reversal connections provide a trouble circuit and an alarm circuit with optional trouble output. The city tie board mounts onto the main board.

Battery Sets

The FC901 control panel is designed to use only rechargeable sealed lead-acid batteries for back-up power. Maximum battery charging capacity for the FC901 is 18AH.

AUXILIARY MODULES

Serial LCD Annunciators

The FSD901 Serial LCD Annunciator consists of a backlit 160 by 64 dot LCD display, -, acknowledge, silence, unsilence, and reset buttons, a four-way button for event navigation, seven system status LED indicators and a security key switch. To prevent unauthorized system operation, the control buttons are only enabled when the key switch is activated. The display and controls of the FSD901 are the same as those on the front of the control panel. The backlight activates only upon active button press or when events are present in the system to conserve power.

Up to 8 annunciators may be addressed by the communication circuit. Each annunciator requires connection to the Serial Interface circuit on the mainboard, and 24V DC power.

SLC ADDRESSABLE DEVICES

Smoke Detector

The control panel processor sends the sensitivity settings to the detectors and polls the detectors for their status. The detector determines normal, trouble and alarm conditions and communicates the conditions to the control panel.

Variable Thresholds - The detectors can be set to operate in various pre-programmed profiles, depending on the environment where the detectors are used.

Operator Alerts - The control panel can indicate a trouble event automatically on the occurrence of a number of conditions of the detector. The supported conditions include:

- Channel Active
- Unconfigured Device
- Device Type Mismatch
- Device Communication Trouble
- Address Invalid
- Address Unspecified
- Multiple Device Response
- Parameter Error
- Device Type Unknown
- Fatal Fault
- General Trouble
- Dirty
- Replace

Heat Detectors

Addressable heat sensing detectors may be intermixed on the circuit for locations where heat sensing may be the most effective detection method. The heat detectors may be programmed for rate of rise operation or fixed temperature.

Addressable Modules (Monitor and Control)

In addition to detectors, the circuit can communicate with addressable monitor and control modules. Monitor modules allow remote contact closure initiating devices to generate event conditions on the system. Control modules provide the system remote relay outputs or notification appliance circuits

Manual Stations

Addressable manual stations may be intermixed on the circuit with proper response programmed into the control panel.

Programming SLC Devices

SLC devices can be assigned their electronic address and be tested by using the DPU Device Programmer/ Loop Tester.

EVENT HISTORY

The control panel includes a non-volatile memory recording 1000 system events. Identified alarm, trouble, supervisory, status and other significant events will be recorded along with the date and time of occurrence. The history event log can be viewed at the main system display by operating menu controls from the panel. The history event log can also be transferred from the panel to a computer using the FX901-U2 system configuration tool.

Events recorded in the history are:

- Alarm, trouble, supervisory and status conditions
- Alarm silence/unsilence (Manual)
- System reset
- User level login/logout
- Start and stop of quick test
- Expiration of quick test Timer
- Trouble/supervisory reminder
- Acknowledgment
- Trouble/supervisory restored to normal

GENERAL DESIGN FEATURES

Environmental

The FC901 panels and subassemblies are suitable for use in a dry, indoor or protected location.

Power Limiting

The AC power connection, battery wiring and four system status relays are not power limited. All other circuits leaving the control panel meet the requirements for power limited circuits when installed in accordance with the National Electrical Code and local requirements.

Ground Fault Detection

The control panel provides system ground fault detection. Main board ground fault event is annunciated as a trouble condition on the system. In addition, the addressable circuit and serial interface circuit have their own ground detection circuitry and indicator.

System- NAC (+) Ground Fault Threshold $<20k\Omega$

System- NAC (-) Ground Fault Threshold $<20k\Omega$

System- Auxiliary Power (+) Ground Fault Threshold $<5k\Omega$

System- Auxiliary Power (-) Ground Fault Threshold $<5k\Omega$

System- City Tie (+) Ground Fault Threshold $<5k\Omega$

System- City Tie (-) Ground Fault Threshold $<5k\Omega$

SLC grounding detection threshold

SLC(+) – Ground $<5k\Omega$

SLC(-) – Ground $<5k\Omega$

NAC Operation

The notification appliance circuits are controlled by the system microprocessor in accordance with the site specific system configuration.

The notification appliance circuits can operate audible and visual notification appliances. Each NAC can provide any of five software-generated codes or continuous operation to audible notification appliances. Also, each NAC supports synchronization of visual notification appliances.

Silence Inhibit - The control panel may be programmed to inhibit silence for up to four minutes from the first alarm.

All of the NACs are power limited.

Security Features

Multi-level password protection of programming functions prevents unauthorized configuration changes.

Device type supervision: If the device type identifier reported by an addressable detector or module does not agree with the configuration, the system reports a trouble condition.

Device address supervision: The system checks that all configured devices on the addressable device circuit respond to an address poll. The system reports a trouble condition if the following conditions are detected:

- Configured device is missing.
- Unconfigured device is installed.
- Two devices are programmed with the same address.
- Signaling line circuit experiences a wire-to-wire short.
- Signaling line circuit experiences an earth ground condition.

REGULATORY STANDARDS

The FC901 control panel meets the requirements of industry and government regulatory agencies as noted.

Underwriters Laboratories

The FC901 control panel is listed under UL Standard 864 for compliance to NFPA Standard 72 for fire service.

Federal Communications Commission

The DACT meets the Class A requirements of the Code of Federal Regulations (CFR 47), Part 15 for electromagnetic field emissions. The DACT also meets the requirements of the Code of Federal Regulations (CFR 47), Part 68, for connection of equipment to the public switched telephone network.

GENERAL SPECIFICATIONS

Operating specifications for the FC901 are as follows:

Environmental

Operating temperature - 32 - 120°F (0 - 49°C)

Relative humidity - Up to 93% @ 90°F (32°C)

To be installed in a indoor dry protected environment only

Primary Power Supply

Input: 120VAC, 60 Hz or 220 VAC, 50 Hz

@ 2.0A Max.

Supervised

Output: 26VDC @ 6.5A Max.

Max current: 6.5A (2 hours Max.)

Filtered and Regulated

Secondary Power Supply

24V lead-acid battery set

Max. charged voltage: 27.8 VDC

Automatic low battery disconnect voltage: 19.2±0.1VDC

Max. charge current: 0.45A

Battery capacity: 12AH to 18AH

Supervised

Auxiliary Power Outputs

Non-resettable power output

Power limited

Alarm status: 0.75A

Normal stand by: 0.05A

Voltage: 19 to 28VDC

Ripple: 0.1 VAC

Special Application

Resettable power output

Power limited

Alarm status: 0.75A

Normal stand by: 0.05A

Voltage: 19 to 28VDC

Ripple: 0.1 VAC

Special Application

Status Relays

Non-power limited

One programmable relay

Three non-programmable relays: Trouble, Supervisory, Alarm

Contact rating: 2A, 30VDC maximum

Form C contact

Notification Appliance Circuits

Power limited

Supervised

Current Draw	Maximum Line Resistance
2.5A	3.2Ω
2.0A	4.0Ω
1.5A	5.3Ω
1.0A	8.0Ω
0.5A	16.0Ω

Alarm voltage: 16 to 32VDC

Maximum ripple: 0.1VAC

Used for special application only

Two Style Y/Class B or one Style Z/Class A

Total Max. Current: 2.5A

Serial Interface Circuit

Power limited

Supervised

Maximum wire loop resistance: 50 ohms total

Physical layer: RS485

SLC Addressable Device Circuits

32 VDC Max

Power limited

Supervised

Max. current: 0.07A(RMS)

Maximum wire loop resistance: 50Ω

Two Style 4 Class B or one Style 6 Class A circuit

Max. 50 addressable devices

City Tie Circuits

Supply Input:

Voltage: 26 VDC

18 – 28 VDC for battery

Current: Max. 0.4A

Supervised

Output:

City Tie-Output 1

Normal output voltage: 19-28VDC (open circuit condition)

Supervisory current: 1mA

Maximum trip current: 400mA

Maximum coil plus wire resistance: 22.5Ω

Leased line-Output 1

Normal output voltage: 19-28VDC (open circuit condition)

Trouble output voltage: 0V

Alarm output voltage: -(19-28)VDC (open circuit condition)

Maximum wire resistance: 2-5KΩ

Maximum short circuit current: 25mA

Leased line-Output 2

Normal output voltage: 19-28VDC (open circuit condition)

Supervisory output voltage: -(19-28)VDC (open circuit condition)

Maximum wire resistance: 2-5KΩ

Maximum short circuit current: 25mA

DACT Circuits

Power limited

Supervised for short or open circuit conditions

Compliance to FCC part 68

Support RJ31X connection

Compatible Digital Alarm Communication Receiver (DACR) list,

Device Module	Manufacture
MX8000	Honeywell

CAUTION – To reduce the risk of fire, use only No. 26 AWG or larger telecommunication line cord.

CONTROL PANEL OPERATION

OPERATION INSTRUCTIONS

Standby Condition

In normal standby operation, the green AC POWER ON LED should be illuminated and no other indicator operating. The display will show the system label and the current time.

Alarm Conditions

ALARM

When the system detects an alarm condition, the alarm LED activates (ON – flashing) and the local panel buzzer activates in a specific pattern to indicate an alarm condition. Programmed system outputs, including audible and visual notification appliances, relays activate, and the LCD display indicates the zone or point initiating the alarm.

Upon receipt of an alarm, building occupants should proceed in accordance with the established emergency response plan. System responders should assure that all personnel are accounted for, and notify the Fire Department.

Operating the ACKNOWLEDGE button will silence the local panel buzzer and change the LED alarm indicator from flashing to steady. The LCD display will indicate that the active events have been acknowledged.

To silence the audible and/or visual notification appliances (where permitted by the codes and control panel programming), press ALARM SILENCE. The notification appliances will be deactivated, and the alarm silence LED will be off.

POSITIVE Alarm Sequence (PAS)

Activation of an initiating device in an input group programmed for PAS activates the Alarm LED, LCD display, and the local panel buzzer. System and user-programmed outputs do not activate immediately.

Operation of the ACKNOWLEDGE button within 15 seconds of the activation of the initiating devices will delay activation of system and user-programmed outputs between 60 and 180 seconds(selected during system configuration) for the purpose of investigating the alarm. If the ACKNOWLEDGE button is not operated within 15 seconds, the system and user-programmed outputs activate at the expiration of the 15 second delay.

If the initiating device and the panel are reset before the programmed delay expires, the alarm sequence is aborted.

During the investigation period, an alarm condition on a detector programmed for direct alarm response (such as the key switch on a manual station) will override the programmed delay and activate the additional user-programmed outputs immediately. User can configure Manned status of FACP to enable/disable PAS feature. FACP will not perform PAS feature in Unmanned status. After logged in as L2/L3 user, user can select Unmanned item in operate menu to enter Unmanned status and bypass all on-going PAS alarms.

PRE-SIGNAL ALARMS

Activation of an initiating device in an input group programmed for PRE-SIGNAL, activates the Alarm LED, LCD display, and the local panel buzzer. System and user-programmed outputs activate immediately except NAC.

The delay of activation of user-programmed outputs can be programmed from 60 to 180 seconds. If the system is not reset during this period, the NAC outputs will activate.

During the delay period, an alarm condition on a detector programmed for direct alarm response (such as the key switch on a manual station) will override the programmed delay and activate the user-programmed NACs immediately.



Do not reset the system until the alarm condition has been cleared. The LCD display will indicate the area in which the alarm was detected. The detector or module associated with the device initiating the alarm will display a light indicating activation (if applicable).

When the alarm condition has been corrected, return the system to standby operation by pressing the RESET button.

Trouble Conditions

When the system detects a trouble condition, the trouble LED will be flashing, the LCD displays trouble events and the local panel buzzer activates in specific pattern that distinguishes the event from an alarm event. Refer to the applicable section of the system manual to determine the probable cause of the trouble and the action to be taken.

Operating the ACKNOWLEDGE button will silence the local panel buzzer and change the LED trouble indicator from flashing to steady. The LCD display will indicate that the active events have been acknowledged.

If the panel is configured for Supervisory/Trouble Resound Reminder, and the trouble condition is not corrected the local panel buzzer will re-activate when the reminder timer has relapsed to remind users of the trouble condition.

If the FC901 is configured as "Trouble self restoring", the system shall return to the "system normal" status if the trouble condition is restored, unless there are additional events on the system. If the FC901 is not configured as "Trouble self restoring", the system reverts to standby condition only after the RESET button is pressed.

Supervisory Conditions

When the system detects a supervisory condition, the supervisory LED will be flashing, the LCD display supervisory events, and the local panel buzzer activates in a specific pattern that distinguishes it from an alarm event.

Operating the ACKNOWLEDGE button will silence the local panel buzzer and change the LED supervisory indicator from flashing to steady. The LCD display will indicate that the active events have been acknowledged.

If the panel is configured for Supervisory/Trouble Resound Reminder, and the supervisory condition is not corrected, the local panel buzzer will re-activate when the reminder timer has relapsed to remind users of the supervisory condition.

If the FC901 is configured as “Supervisory self restoring”, the system shall return to the “System Normal” status if the supervisory condition is restored unless there are additional events on the system. If the FC901 is not configured as “Supervisory self restoring”, the system reverts to standby condition only after the RESET button is pressed.

ADDITIONAL OPERATING PROCEDURES

In addition to the basic fire alarm instructions above, several features are included to facilitate maintenance and increase the versatility of the system. The following are procedures used to initiate these functions.

Lamp Test

When selected, Lamp Test activates LCD, the buzzer and turns on all the LEDs on the user interface, then back to its previous state.

To initiate a Lamp Test, proceed as follows:

Press "MENU".

On the MENU display, select "Oper".

Select "Lamp Test" to run.

Note that lamp test operates the indicators only on the units being operated and no record is reported to system history.

The lamp test lasts 10 seconds. From 0 to 4 seconds LCD test; From 4 to 7 seconds LEDs test; From 7 to 10 seconds buzzers test. Operator doesn't need to turn it off manually. Lamp test will automatically quit when it completes.

History

The last 1000 system events are time-tagged and recorded for review in the user level event history. This history and all user-level functions are available to users with the door key.

Operation of history:

New events overwrite old when filled.

For more information see the Event History section.

Access to history:

To recall past events, proceed as follows:

- Press "MENU" button.
- On the "MENU" display, select "View".
- Select "History".

Operate up button adjacent to the LCD for previous event display.

Operate down button adjacent to the LCD for next event display.

FC901 OPERATING INSTRUCTIONS

Alarm Operation

In case of alarm, the *Alarm* LED flashes, LCD displays alarm conditions and the panel buzzer sounds in a distinct alarm pattern. Local audible and visual signals and remote alarm signals operate.

When an alarm occurs, proceed according to the established emergency plan. Assure that all personnel are accounted for, and notify the Fire Department to advise of the alarm and/or verify that an automatic signal has been received at the Fire Department.

Authorized Personnel Only

To acknowledge the alarm:

To acknowledge the alarm, press the *Acknowledge* button. The local buzzer will be silenced and the Alarm LED will change from on-flashing to on-steady.

To silence the alarm:

To silence the notification appliances after evacuation, where permitted, press the *Alarm Silence* button. The silenceable notification appliances will be silenced. The *Silenced* LED will change from off to on-steady.

Note: Do not reset the panel until the alarm has been cleared.

Warning: Alarm silence inhibit (if set) prevents the alarm from being silenced for a predetermined time.

To reset panel after alarm:

When the alarm condition is corrected, return the panel to normal standby operation by pressing the *Reset* button.

Trouble Operation

Trouble is indicated by:

Trouble LED flashes, LCD displays trouble conditions. Panel buzzer sounds in trouble pattern.

To acknowledge the trouble:

Press the *Acknowledge* button. The *Trouble* LED turns on-steady and the buzzer turns off. When the trouble condition has been cleared, you need to reset the panel to restore to a normal standby condition if panel is not configured as "Trouble self restoring". When panel is configured as "Trouble self restoring", it will restore automatically to normal standby condition after clearing of trouble condition.

Warning: devices in trouble condition may not report a fire alarm.

Event Scrolling

Viewing Events on the System:

Events are displayed according to the following rules:

1: Events priority:

Unacknowledged Alarm > Unacknowledged Supervisory > Unacknowledged Trouble > Acknowledged Alarm > Acknowledged Supervisory > Acknowledged Trouble > Status > Test

2: Within events of the same priority, all events are displayed in the order of occurrence with the latest displayed the first.

3: Status events are displayed according to the event setting. If it is configured as "No display", it will not be listed in Event List.

Fuse Replacement and Battery Maintenance

Battery fuse(F304): 15A blade type (Littelfuse: 0257015.PXPV or Bussmann: ATC-15)

City tie fuse(F1-F4): 1.25A cartridge type (Littelfuse: 02151.25P or Schurter: SPT 0001.2505)

This product requires two 12V batteries in series, for a combined voltage of 24V. Replace batteries every 3 to 5 years.

Recommended battery manufacturers:

Power Sonic: PS-12120, PS-12140, PS-12180 Yuasa: NP-12-12

Battery capacity: min. 12Ah / max. 18Ah Charge current: max. 0.45A

For service, contact: _____ **Telephone Number:** _____

Frame these instructions and mount them near the control panel for operator reference.

FSD901 OPERATING INSTRUCTIONS

Alarm Operation

In case of alarm, the *Alarm* LED flashes, LCD displays alarm condition and the buzzer sounds. Local audible and visual signals and remote alarm signals operate.

When an alarm occurs, proceed according to the established emergency plan. Assure that all personnel are accounted for, and notify the Fire Department to advise of the alarm and/or verify that an automatic signal has been received at the Fire Department.

Authorized Personnel Only

To acknowledge the alarm:

To acknowledge the alarm, enable the control buttons by operating the keyswitch, and press the *Acknowledge* button. The local buzzer will be silenced and the *Alarm* LED will change from on-flashing to on-steady.

To silence the alarm:

To silence the notification appliances after evacuation, where permitted, press the *Alarm Silence* button. The silenceable notification appliances will be silenced, and LED indications will change from flashing to continuous. The *Alarm Silenced* LED will be lit.

Note: Do not reset the panel until the alarm has been cleared.

Warning: Alarm silence inhibit (if set) prevents the alarm from being silenced for a predetermined time.

To reset panel after alarm:

When the alarm condition is corrected, return the panel to normal standby operation by pressing the *Reset* button.

Trouble Operation

Trouble is indicated by:

Trouble LED flashes, LCD displays trouble conditions. Panel buzzer sounds (pulsing).

To acknowledge the trouble:

Enable the control buttons by operating the keyswitch, and press the *Acknowledge* button. The *Trouble* LED turns on-steady. When the trouble condition has been cleared, you may need to reset the panel to restore to a normal standby condition.

Warning: Devices in trouble condition may not report a fire alarm.

Event Scrolling

Viewing Events on the System:

Events are displayed in the system by event priority (Unacknowledged Alarm > Unacknowledged Supervisory > Unacknowledged Trouble > Acknowledged Alarm > Acknowledged Supervisory > Acknowledged Trouble > Status > Test) followed by event occurrence (latest to oldest event) in a circular list.

According to settings, some events can be suppressed (not display) on annunciator.

Normal Standby Condition

The green *AC Power On* LED will be lit and no other indicators on.

For service, contact: _____
Telephone Number: _____

Frame these instructions and mount them near the annunciator for operator reference.

PROGRAMMING THE CONTROL PANEL

KEYPAD PROGRAMMING

Customized programming of the control panel may be accomplished through the keypad included in the control panel.

PC PROGRAMMING

Programming the panel may also be done by a temporary connection to the programming port with a computer. This is the recommended method to program the panel.

The Siemens FX901-U2 software is available to allow programming the control panel by connection to a Personal Computer (PC) with an USB port. This allows ease of operation by preparing the program in advance and downloading to the control panel in a simple, rapid operation.

PROGRAMMING SECURITY

The following levels of security protect the system from unauthorized use:

Level 1 (User) – Locked Door

Level 2 (Maintenance) – Locked Door and 4-digit Maintenance Password

Level 3 (Technician) – Locked Door and 4-digit Technical Password

The User Level is also accessible from FSD.

MAINTENANCE

GENERAL

The FC901 provides maintenance functions to allow for the setting and controlling of various features in the system.

The maintenance functions are protected by a four digit password. To access the maintenance features press the “MENU” button and select Login item in the View menu, enter the four digit code when prompted and then press “OK”.

FC901 Maintenance is separated into two levels. The user can enter a different password to enter different levels.

Level 2: Protected by level 2 password, Level 2 provides control functions.

Level 3: Protected by level 3 password, Level 3 provides control functions and parameter change functions.

The following functions are accessible to L2 and L3 user by selecting items in the Operate menu.

Disable/Enable Devices

Disable/Enable NACs

Disable/Enable City Tie

Disable/Enable DACT

Disable/Enable Status Relays

Disable/Enable Detector Applications

Disable/Enable PAS

Starting and Configuring Quick Test

Set the Time

Set the Date

The functions listed below are provided specifically to L3 users.

Edit Device Labels

Edit System Labels

Program a Device

Change the Maintenance Password



Disabling any input and output devices, applications will annunciate a trouble condition.

QUICK TEST

The Quick Test mode makes it fast and easy to test a system by eliminating the need to disconnect panel from remote connections to the Fire Department or other monitoring stations. In this way, operator can test all devices locally without annunciating any condition to remote connections.

To configure the Quick Test parameters, enter L2 user level and navigate to the Quick Test item in the Operate menu. Configure the following parameters prior to starting Quick Test:

- Quick Test Time – FC901 will automatically quit Quick Test mode after the configured time
- Disable Output – Don't activate any output on events in Quick Test Mode
- Annunciator Off – Don't send any events to annunciators in Quick Test Mode.
- History Off – Don't record any events in History Record in Quick Test Mode
- NAC Off – Don't activate NAC in Quick Test Mode

To initiate the Quick Test mode, enter L2 user level and navigate through the menu for the Quick Test option and then select "START". Test conditions will be annunciated on the panel to indicate that panel is in Quick Test Mode. Initiation of any addressable device will not activate associated NACs if "NAC OFF" is enabled in Quick Test mode.

By selecting the Extend (Quick Test) item in the Operate menu, L2 user can extend the quick test time. L2 user can quit the quick test mode by selecting the Cancel (Quick Test) item in the Operate menu.

HZM in Quick Test

Testing conventional detectors in Quick Test requires a few more steps than testing addressable devices. Since the HZM only guarantees that one detector will stay in active at a time, its detector loop must be reset after each detector is activated. This can be accomplished in the following ways:

- By shorting the device loop for at least six seconds.
- By interrupting power to the device loop or the active device for at least six seconds.

Either of these methods will cause the active detector to reset.



The previous detector must be clear of smoke after resetting the loop or it will generate another alarm.

This page is left intentionally blank.

APPENDIX-A: REFERENCE DATA

This appendix provides reference for the following topics:

Wire selection guides

Battery size calculations

WIRE SELECTION GUIDES

Resistance of Solid Copper Wire

AWG	Ohms per Thousand Feet*
18	8.08
16	5.08
14	3.19
12	2.01

*NEC Chapter 9, Table 8.

Addressable Device Circuit Wire Selection Guide

Each addressable device circuit must meet the following requirements:

Total loop resistance - 50 ohm maximum with 50 devices

Total loop capacitance - 0.5uF max line to line per km and 1.0uF max line to shield per km



The terminal blocks of Siemens SLC devices are rated for a maximum of 14AWG wire.

BATTERY SIZE CALCULATIONS

Total System Currents

	STANDBY (A)	ALARM (A)
Main board	0.178	0.203
NAC	0	2.5
SLC	0.07	0.07
Auxiliary power	0.1	1.5
City tie module	0.001	0.04
Total	0.349	4.313

Use the Total Panel + Modules + Devices for the Battery Size Calculations

Battery Size

Total Standby Current (from above)	Hours of Standby Required per NFPA 72 Standard (4, 24 or 90)	AH for Standby
A	X Hours	=

Total Alarm Current (from above)	5 Minutes of Alarm Operation per NFPA 72 Standard	AH for Alarm
A	X Hours	=

A.H. for Standby	A.H. for Alarm	Calculated A.H.	De-rating Factor	A.H. Required Battery Capacity
	+	=	X 1.1	=

Notes:

An additional multiplier is included to compensate for the higher discharge rate in alarm.
Battery capacity decreases with age.

APPENDIX-B: COMPATIBLE DEVICES

DEVICES FOR ADDRESSABLE DEVICE CIRCUITS

Siemens SLC Manual Pull Stations

Siemens Cat. No.	Description
HMS-S	Manual Station, Single Action
HMS-D	Manual Station, Double Action
HMS-M	Metal Manual Station, Single Action
HMS-2S	single action manual pull station with 2-stage key switch

Siemens SLC Modules

Siemens Cat. No.	Description
HTRI-M	Transmit-Receive Interface – Mini-Module
HTRI-S	Transmit-Receive Interface – Single Monitor Circuit
HTRI-D	Transmit-Receive Interface – Dual Monitor Circuit
HTRI-R	Transmit-Receive Interface – Dual Monitor Circuit with Programmable Relay
HCP	Intelligent Control Point
HLIM	Line Isolator Module

Siemens SLC Bases

Siemens Cat. No.	Description
DB-11	Detector Base
DB-11E	Detector Base
ADBH-11	Audible Base
DB-HR	Relay Base
DB2-HR	Relay Base

Siemens SLC Accessories

Siemens Cat. No.	Description
ILED-HC	Intelligent Remote Lamp, Ceiling mount
ILED-HW	Intelligent Remote Lamp, Wall mount
RL-HC	Remote Lamp, Ceiling mount
RL-HW	Remote Lamp, Wall mount
AD2-XHR	Air Dust Housing with Relay
AD2-P	Air Dust Housing

8700 SLC Manual Pull Stations

Siemens Cat. No.	Description
8700-S	Manual Station, Single Action
8700-D	Manual Station, Double Action
8700M	Metal Manual Station, Single Action

8700 SLC Detectors

Siemens Cat. No.	Description
8710	Photo Detector
8712	Thermal Detector, Fixed or Fixed/Rate of Rise
8713	Photo/Thermal Detector

8700 SLC Modules

Siemens Cat. No.	Description
8702	single input interface module
8703	dual input interface module
8704	single input interface module with relay
8701	mini single input interface module
8706	intelligent control point
8705	conventional zone module
8709	Line isolator

8700 SLC Bases

Siemens Cat. No.	Description
8853B	Detector Base
8715	Detector Audible Base
8716	Relay Base

8700 SLC Accessories

Siemens Cat. No.	Description
8726C	Intelligent Remote Lamp, Ceiling mount
8726W	Intelligent Remote Lamp, Wall mount
8727C	Remote Lamp, Ceiling mount
8727W	Remote Lamp, Wall mount
8741	Air Dust Housing with Relay
8743	Air Dust Housing

Notes:

1. Siemens SLC devices, detectors and modules, up to a maximum of 50 addresses may be used.
2. For specific wiring and installation information, read the instructions provided with each device.
3. If more than one HCP is used on a SLC device loop, the loop must be wired Class A or the riser conductors must be installed in accordance with the Survivability From Attack By Fire requirements in the National Fire Alarm Code, NFPA 72. If wired Class A, at least one HLIM loop isolator must be installed between each HCP and between the panel and the first and last HCP. See the HLIM installation instructions for the maximum number of isolators allowed per loop and other wiring instructions.

FD182UL

Point detectors	Description
OP920	Smoke detector
OH920	Smoke heat detector
HI921	Heat detector

Global ASA

Point detectors	Description
OOH941	dual optical/thermal multisensor detector
OOHC941	dual optical/thermal

DEVICES FOR NOTIFICATION APPLIANCE CIRCUITS

Please refer to A6V10333532

APPENDIX-C: TROUBLESHOOTING

DEFINITIONS FOR EVENT HISTORY ENTRIES

A. General

ENTRY	INDICATES
Disabled	The device has been disabled
Ground	The device is in ground fault
Open	The device is in open trouble
Short	The device is in short trouble
Overload	The SLC line is overloaded
GeneralTrouble	The device reports general trouble
Unconfig	The system finds a SLC device that is not in the config file
TypeMismatch	The SLC device type is not consistent with the config file
CommunicationTrouble	The communication between the device and the panel is abnormal
Multiple Device Response	More than one SLC device has the same address
TypeUnknown	The device type is unknown to the panel
Dirty	The SLC device is dirty
Replace	The SLC device needs to be replaced
ParameterError	The SLC device has invalid parameter setting
AddressInvalid	The address of SLC device is invalid
AddressUnspecified	The SLC device has no address
ACFail	The AC power of the system is in trouble
MessageLost	The DACT lost some messages because of limited memory space
FatalFault	The SLC device reported fatal fault trouble
VoltageLow	The battery voltage is too low
VoltageHigh	The battery voltage is too high
OverCurrent	The NAC is in over current state
CircuitTrouble	The battery charge circuit is in trouble
BatteryAbsent	The battery is missing

B. System Events

ENTRY	INDICATES/NOTES
Reset	Panel reset
Silence	Silence all silenceable outputs
Unsilence	Unsilence all silenced outputs
Test	Start quick test
QuitTest	Exit quick test
Acknowledge	Panel events acknowledged
Unacknowledge	Resound of the trouble/supervisory
LogIn	User level login
LogOut	User level logout

APPENDIX-D: ALARM VERIFICATION

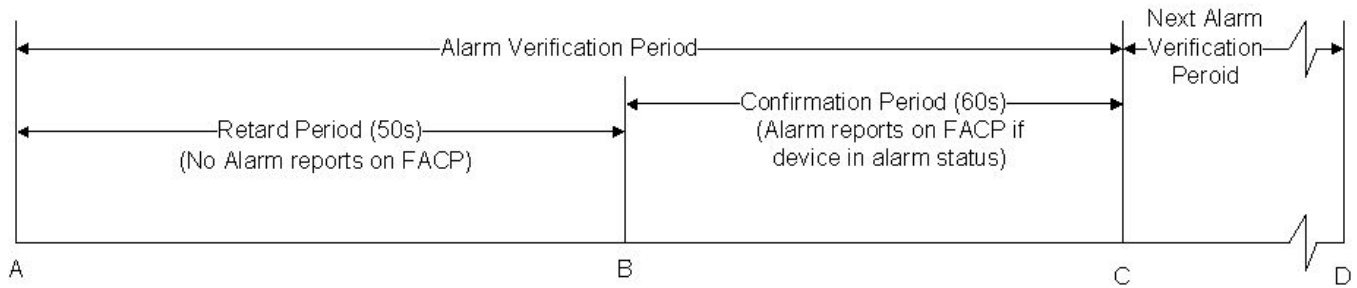

Alarm Verification in FC2005

A - Smoke detector goes into alarm. (LED on device turns to red)

AB - Retard Period, FACP senses detector in alarm and delays alarm signal for 50s. In this period, no alarm event reports on FACP.

BC - Confirmation Period, Detector is operational for alarm at point B. If detector is still in alarm at point B, FACP will report alarm. If detector is not in alarm, system returns to standby. If the detector re-alarms at any time during the confirmation period the FACP will alarm. The period length is 60s.

CD – Restart next alarm verification period if new alarm occurs.

APPENDIX-E: APPLICATION SPECIFIC DETECTION

Application Specific Detection (ASD) allows the system designer to program a detector's sensitivity, pre-alarm threshold, and other alarm-related parameters using English descriptions of the detector's environment (application). This eliminates the need for detailed knowledge of smoke detector terminology and operation. The designer can set all of the critical detector parameters by simply selecting an application description that closely fits the one where the detector is to be installed.

For example, to use ASD to select the optimal parameters for a detector in a hotel lobby, select the LOBBY application in the FX901-U2 tool for that device. The system will automatically transmit the factory determined sensitivity, pre-alarm threshold, and detection algorithm (R-algorithm) to the corresponding device. This eliminates the guesswork of selecting these parameters for different environments.

ASD APPLICATIONS of H-series and 8700-series detector

ASD Application	ASD Description
Disable	No Applications (Standard Photo/thermal Detector)
Office (Retail)	Reasonably clean, climate controlled atmosphere
Warehouse (Light Manufacturing)	Airborne dust, equipment, fork truck and light to medium dock area exhaust fumes
Lobby	Relatively clean area, temperature changes, cellular phones, smoking
Computer Room	Very controlled environment, clean, temperature closely regulated, high cost clean machinery operating, no smoking, high air velocity
Dormitory	Airborne dust and temperature changes, living quarters, cooking fumes, smoking
Healthcare	Higher level risk, relatively clean, electronic equipment
Parking Garage	Airborne dust, car and diesel fumes, temperature swings
Equipment Storage (Transformer) Room	Normal to somewhat dirty environment, heat from running equipment
Precious Storage (Sensitive Environment)	Sensitive materials or equipment storage, clean dust-free environment, earliest warning desired
Hostile Environment	Dirty, dusty, humid, operating equipment, RF present, wide temperature swings
Duct (Open air or duct housing)	Dirty, dusty, humid, wide temperature swings, high air velocity

APPENDIX-F: TESTING/MAINTENANCE

If the system is connected to the fire department, etc., or actuates an internal system, disarm the appropriate outputs before servicing to prevent actuation. Notify the fire department and personnel at your facility that a System test is being performed so that any alarm sounding can be ignored during the test. Notify the fire department before resetting the system.

Inspection, Testing, and Maintenance of the fire alarm system should be performed in accordance with NFPA 72, The National Fire Alarm Code and all applicable local codes.

BATTERY MAINTENANCE

Perform the following tests at the recommended interval. Replace the battery set every four years or if any of the test criteria are not met.

Initiation / Reacceptance

1. Charger Test—With the batteries fully charged and connected to the charger, measure the voltage across the battery set. It must read 27.3V +/- 0.3V.
2. Discharge Test—With full system alarm load, the voltage on a fully charged battery must not fall below 20.4V after 30 minutes.
3. Load Voltage Test—With full system alarm load, the voltage on a fully charged battery must not fall below 24.6V after one minute.

Testing Interval

1. Semiannually—Perform the Load Voltage Test.
2. Annually—Perform the Charger Test and Discharge Test.

APPENDIX-G: LCD, CONTROLS AND INDICATORS

The FC901 has a buzzer, 7 LEDs, 4 navigational push buttons, 4 dedicated push buttons, alphanumeric keypad, 3 menu control buttons (menu, cancel, ok) and a communication port connector.

Communication Port Connector

The communication port is connected to the USB port of the computer that has the FX901-U2 programming tool. This is used to upload and/or download panel configuration if this method of programming is used.

The computer must be disconnected from the panel if not in use.

LEDS, Buzzer and Dedicated Push Buttons

The LEDs operate as follows:

Power	Green	Steady ON	This indicates that the system's power works normally. Both the main power and battery are in normal status.
		OFF	This indicates that the system is not powered on yet. This LED can be OFF only when the system is shut down.
		Flashing	This indicates that the main power is in trouble status and system is working on battery.
Alarm	Red	Steady ON	This indicates that there are alarm events, and all alarm events have been acknowledged.
		OFF	This indicates that there is no alarm event in system.
		Flashing	This indicates that there are alarm events in system, but some of them have not been acknowledged.
Silenced	Yellow	Steady ON	The Silenced LED can only be steady on when the following conditions are all met: 1. There are activated silenceable devices, and all of them have been silenced. 2. There is no non-silenceable NAC activated.
		OFF	The Silenced LED will be OFF when above conditions cannot be met.
Trouble	Yellow	Steady ON	This indicates that there are trouble events, and all of them have been acknowledged.
		OFF	This indicates that there is no trouble event in system.
		Flashing	This indicates that there are trouble events in system, but some of them have not been acknowledged.
Supervisory	Yellow	Steady ON	This indicates that there are supervisory events, and all of them have been acknowledged.

		OFF	This indicates that there is no supervisory event in system.
		Flashing	This indicates that there are supervisory events in system, but some of them have not been acknowledged.
Ground Fault	Yellow	Steady ON	This indicates that there are Ground Fault events in system.
		OFF	This indicates that there is no Ground Fault event in system.
		Flashing	This indicates that there are ground fault events in system, but some of them have not been acknowledged.
Audibles On	Red	Steady ON	The Audibles On LED can only be steady on when any of the following conditions are met: 1. There are activated NACs and some of them are not silenced. 2. There are silenceable devices activated and some of them are not silenced.
		OFF	The Audibles On LED will be OFF when above conditions are not met.

The buzzer operates as follows:

Normally OFF – indicates that the system is in normal condition or all events in the system have been acknowledged.

ON (200 pulse per minute) – indicates that at least ONE unacknowledged alarm is present in the system.

ON (85 pulse per minute) – indicates that at least ONE unacknowledged non-alarm (trouble, supervisory) event is present in the system.

The buttons operates as follows:

Alarm Silence	Press	Silences all silenceable devices in system. This will cause all activated silenceable devices to become silenced.
Acknowledge	Press	Acknowledges all unacknowledged events in system.
Reset	Press	Clears all obsolete events and resets all devices, except those disabled ones and hold-through-reset devices in system.
Unsilence	Press	Unsilences all silenced devices in system. This will cause all silenced devices to become activated.
Menu	Press	Menu button for PMI operation.
OK	Press	OK button for PMI operation.
C	Press	Cancel button for PMI operation.
0-9	Press	Numeric buttons for PMI operation. They are used to enter the password to access the maintenance and technician modes of the panel. It allows the user to program the panel using these keypads without using the FX901-U2 programming tool.
*	Press	* button for PMI operation.
#	Press	# button for PMI operation.
Four-way button	Press	A four-way button for menu navigation.

LCD Display

The LCD operates as follows:

```
Trouble 02/13 L2 12:12
V AutoAlarm IN
Zone 1
10-30-2010 12:00:01
V Open IN
Line 1
10-30-2010 12:00:00
```

Line 1 – Index and Category of current selected event, User level, current time

Line 2 – Acknowledged status, Event Type

Line 3 – Customer text of the device associated with the event

Line 4 – Time when the event happened

Line 5~7 – Another event followed

The LCD can display two events at a time. User can cycle through a circular list once the first event or last event message is reached.

Events are displayed according to the following rules:

1: Events priority:

Unacknowledged Alarm > Unacknowledged Supervisory > Unacknowledged Trouble >

Acknowledged Alarm > Acknowledged Supervisory > Acknowledged Trouble > Status > Test

2: Within events of the same priority, all events are displayed in the order of occurrence the latest displayed the first.

3: Status events are displayed according to the event setting. If it is configured as “No display”, it will not be listed in Event List.

When Supervisory is configured as Non-SelfRestoring, a Supervisory OUT Event will be displayed in the event list when supervisory condition disappears. This also applies to Trouble and Status.

APPENDIX-H: OUTPUT FEATURES

Output Activation- and Deactivation- Delays

Each output device has a selection for Activation delay and Deactivation delay when it is installed in the configuration. The Activation delay refers to the delay in which the output will activate after the reception of its activation command. If the Activation delay is set to 0 (default setting), the output immediately activates. The Deactivation delay refers to the delay in which the output will deactivate after the reception of its deactivation command. If the Deactivation delay is set to 0 (default setting), the output immediately deactivates.

Output device during activation delay will not respond to deactivate command. This means an output device with activation delay will definitely be activated after receiving activate command. Output device during deactivation delay will respond to activate command immediately and the deactivation delay will be cancelled.

Assuming an output channel on SLC is configured to be interlocked by supervisory condition of FACP with ActivationDelay of 10s and Deactivation Delay of 10s. When FACP enters supervisory condition at 00"00', the output channel will be activated at 00"10'. Then if the supervisory condition goes at 00"30', the output channel will be deactivated at 00"40'.

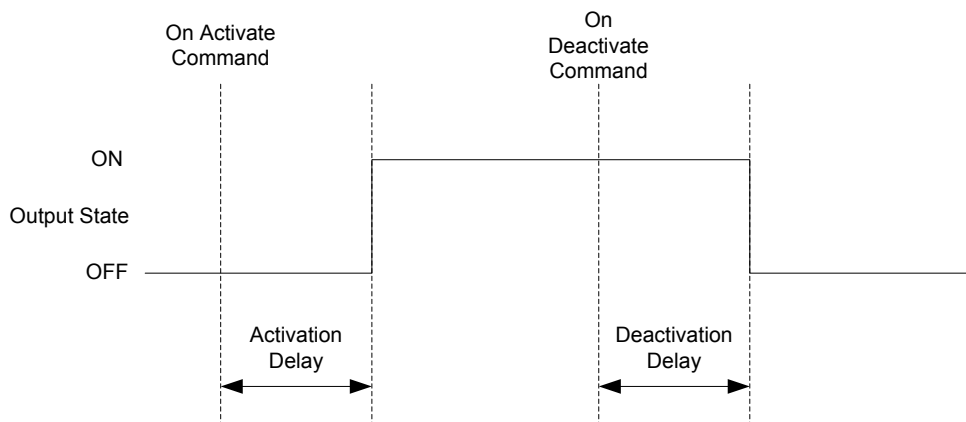

This function only apply to IO module on SLC

APPENDIX-I: PAS / PRE-SIGNAL

PAS (Positive Alarm Sequence) and Pre-Signal features allow the user to delay the activation of the audibles, strobes and other output devices when an initial alarm is detected. Output can be interlocked by zones. When an initial alarm is detected, all outputs except remote devices (off-premises devices like general relays and city tie) associated with PAS Zone (Zone configured with PAS feature) will be activated immediately. When PAS delay timer elapses, other remote devices will also be activated. The delay timers are configurable.

PAS

When an alarm causing device associated with a zone with PAS feature is initiated, the alarm condition is reported on the panel. The activation of its related remote outputs (e.g. output relays) are delayed for 15 seconds (PAS delay time) waiting for a manual acknowledgement response.

If no response is received within 15 seconds, the panel proceeds to activate the associated remote outputs. See Figure A.

If the alarm event is acknowledged during the PAS delay time, the programmable PAS investigation time (60-180 seconds) is added to the PAS delay time before remote outputs are activated. See Figure B.

However, if a 2nd alarm is initiated anytime during the PAS delay time or PAS investigation time, the remote output devices are immediately activated. See Figure C.

Pressing the Reset button at anytime during the PAS sequence will initiate a reset condition and restore the panel to stand-by state.

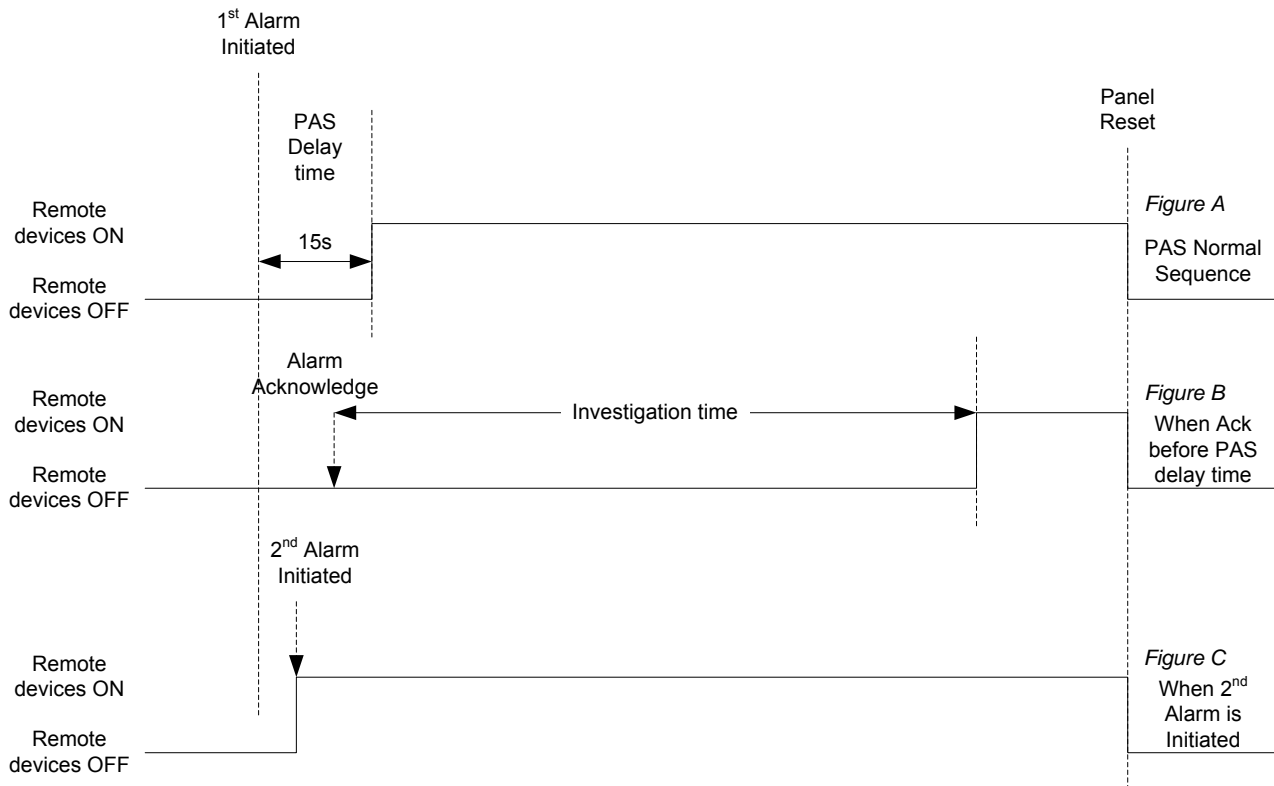

Pre-Signal

When an alarm causing device in a Pre-Signal input group is initiated, the alarm condition is reported at the panel. Its associated NACs are not activated until the programmed investigation delay has elapsed or 2nd Alarm is initiated anytime during the Pre-Signal delay time (see figure below).

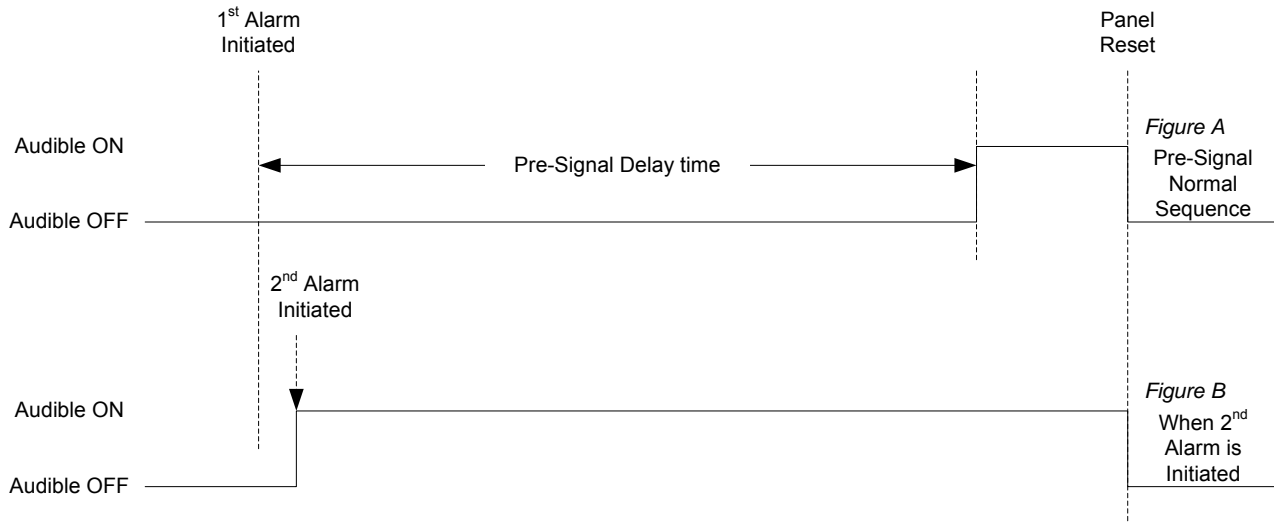

Pressing the reset button at anytime during the Pre-Signal sequence will initiate a reset condition and restore the panel to stand-by state.

APPENDIX-J: DACT INFORMATION OVERVIEW

The DACT (Digital Alarm Communicator Transmitter) is an optional module for the FC901 control panel that allows transmission of event information to a remote receiver at a monitoring station using a dial-up modem connection. These events are transmitted in one of the following formats:

- SIADCS 8
- SIADCS 20
- ADEMCO Contact ID
- 4/2 1400 HZ
- 3/1 1400 HZ
- 3/1 2300 HZ
- 4/2 2300 HZ

A few aspects of the operation of the DACT are clarified below.

Lines / Accounts

The DACT supports two independent lines and can report to two separate accounts. “Lines” should not be confused with “accounts”. “Lines” are the actual telephone cords that plug into the DACT module, which are in turn connected to the PSTN (Public Service Telephone Network). If line 1 is not functioning (no dial tone, etc.), the DACT will try line 2 instead.

“Accounts” are the phone numbers that the DACT dials. Once the DACT has found a “live” line to dial out on, it transmits the event(s) on that line, starting with the first account that is configured to send that event. If the first account does not respond after the programmed number of attempts (busy, account not responding, etc.), the DACT will automatically attempt to send the event to the second account, providing the event is set to report for that account.

The DACT may be configured for connection to lines that are set up for Rotary and/or Tone dialing. See the FC901 Programming Manual, P/N 315-0494033, for details.

Must / Can / Must Not

Each event type (Alarm, Alarm Restoral, etc.) can be configured as “Must”, “Can” or “Must Not” report independently for each account. If configured as “Must Not” report, the DACT will not report the event to that account. If configured as “Can” report, the DACT will only attempt to report the event to the account if it has not reported it on the other account. If configured as “Must” report, the DACT will attempt to report the event to the account even if it has already reported it to the other account. In summary:

Must Report The event will be reported to this account even if it has reported it to the other account.

Can Report The event will only report to this account if it has not been successfully reported to the other account.

Must Not Report The event will never report to this account.

To configure an event to be reported to Account 1 *and* Account 2, set it to Must report on both. If the event needs to be reported to either Account 1 *or* Account 2, set it to Can report on both. If it *has* to be reported to Account 1, but only needs to be reported on Account 2 if Account 1 is temporarily out-of-order, set the event to Must Report on Account 1 and Can Report on Account 2.

Following are examples for illustration purposes.

Scenario 1 – Must/Must
Alarm Event is set to Must Report on Account 1 and 2.

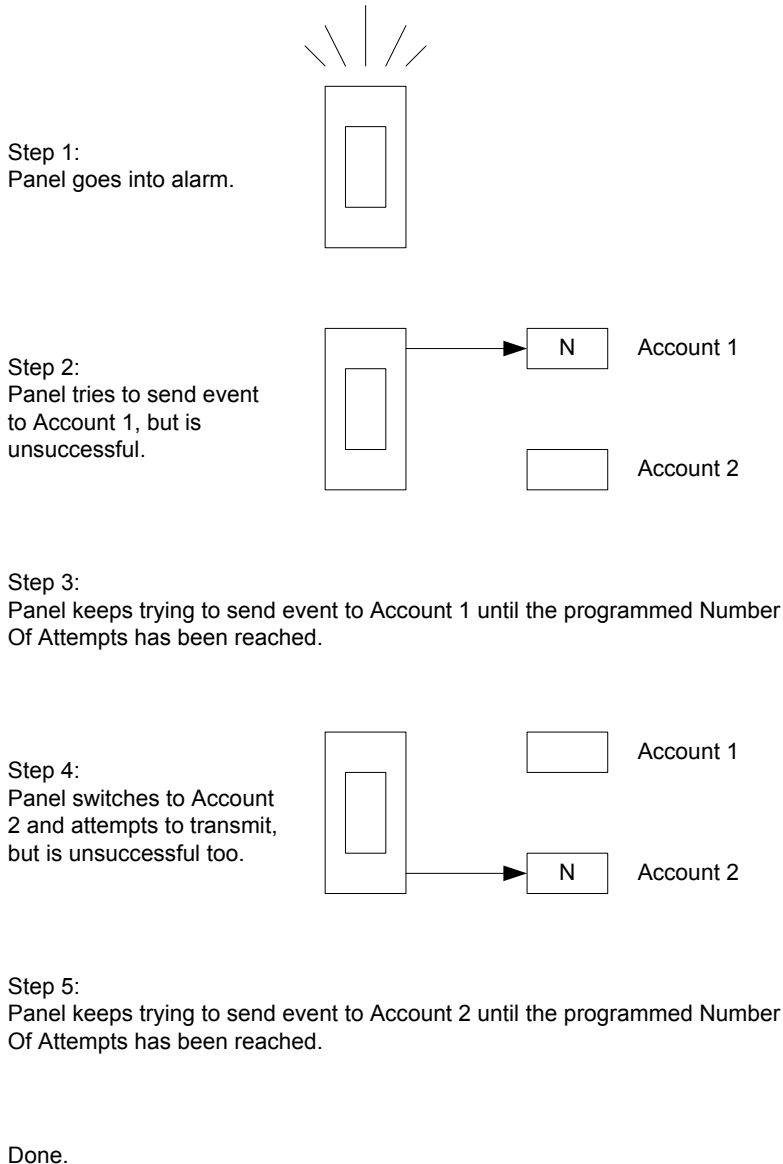

Note: If both accounts failed to send an event within configured Number of Attempts, the event will be discarded and a message lost condition will be declared on panel. This means the panel will not try infinitely to send an event and each account can try at most (programmed Number of Attempts) times. This applies to all Scenarios of DACT transmission.

Scenario 2 – Must/Can
Alarm Event is set to Must Report on Account 1 and Can Report on Account 2. Panel fails on Account 1 the first time.

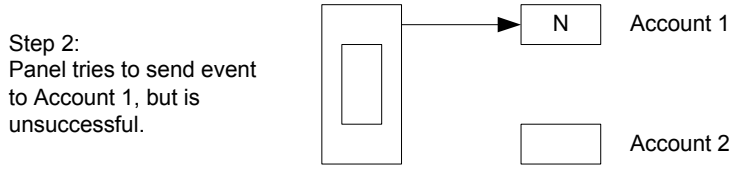
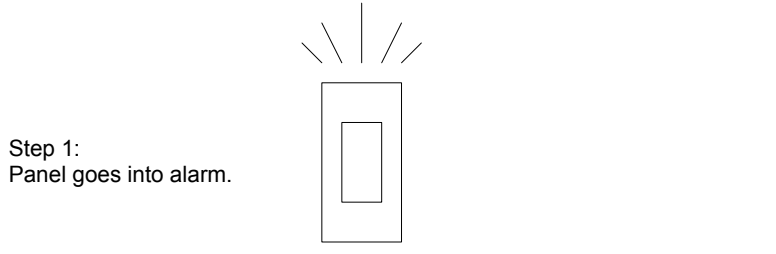

Step 3:
Panel keeps trying to send event to Account 1 until the programmed Number Of Attempts has been reached.

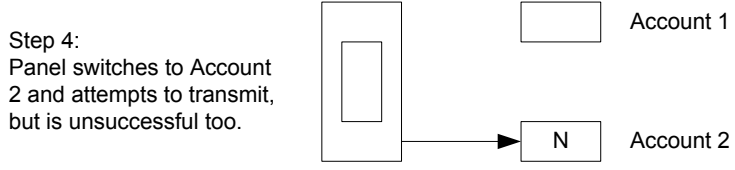

Step 5:
Panel keeps trying to send event to Account 2 until the programmed Number Of Attempts has been reached.

Done.

Scenario 3 – Must/Can
Alarm Event is set to Must Report on Account 1 and Can Report on Account 2. Panel succeeds on Account 1 the first time.

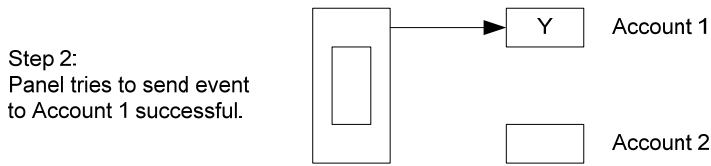
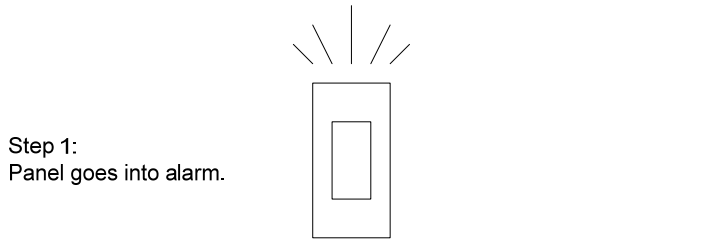

Step 3:
Panel does NOT attempt to send event to Account 2, since Account 2 is set for Can Report and the event was transmitted to Account 1 successfully.

Done.

Scenario 4 – Can/Can
Alarm Event is set to Can Report on Account 1 and
Account 2. Panel succeeds on Account 2 before Account
1.

Step 1:
Panel goes into alarm.

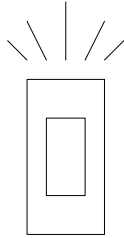

Step 2:
Panel tries to send event to Account 1, but is unsuccessful.

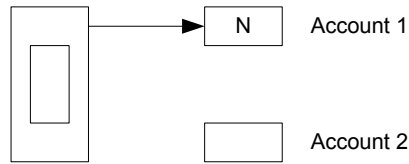

Step 3:
Panel keeps trying to send event to Account 1 until the programmed Number Of Attempts has been reached.

Step 4:
Panel switches to Account 2 and successfully transmits the event.

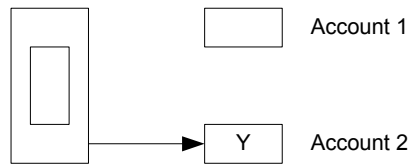

Done.

Note: The same sequence of events would happen if Account 2 was set to Must Report.

APPENDIX-K: GLOSSARY

AC Power Fail. Refers to a condition in which AC power loss is detected by the system.

Alarm Signal. A signal indicating an emergency requiring immediate action, such as an alarm for fire from a manual station, a waterflow alarm, or an automatic smoke detector.

Alarm Silence Inhibit. An option that prevents an operator from silencing the notification appliances for a preset period of time.

Alarm System. A combination of compatible initiating devices, control panels, and notification appliances designed and installed to produce an alarm signal in the event of a fire.

Alarm Verification. A preset option that causes the control panel to verify alarms originated by smoke detectors before indicating an alarm.

Annunciator. A remotely located, electrically powered display, separate from the control panel, containing LEDs or lamps to indicate the states of the fire alarm system.

Audible Signal. An audible signal is a sound made by one or more audible notification appliances, such as bells or horns, in response to the operation of an initiating device.

Auto-Silence. The capability of a control to automatically silence the notification appliances after a preset period of time.

Class A Circuit. An initiating device or notification appliance circuit within which all components remain fully functional, even though a single open or ground exists in the circuit.

Class B Circuit. An initiating device or notification appliance circuit within which some or all components may be disabled with a single open exists in the circuit.

Detector - FirePrint™. An intelligent fire detector that blends photoelectric, thermal and neural network technologies for superior protection without false alarms.

Detector - Smoke, Photoelectric Type. A detector employing the photoelectric principle of reflection or obstruction of light by smoke.

Detector - Thermal Type. An addressable thermal sensor that is programmable as either a fixed temperature (135° F) or as a rate of rise detector.

Enable / Disable. Refers to the state of individual circuits (inputs and outputs) or logic functions regardless of the presence of its corresponding modules.

End Of Line (EOL). A device used to terminate a supervised circuit.

Ground Fault. A trouble condition in which a low resistance has been detected between the system wiring and conduit ground.

Hold-Thru Reset Condition. Refers to a condition where the hold-thru reset output will remain in its current state before and after the reset until the OFF time delay has elapsed. Initiation of

fan restart usage has higher priority than the OFF time delay and will therefore immediately deactivate the hold-thru reset outputs.

Initiating Device. A manually or automatically operated device such as a manual pull station, smoke detector, heat detector, waterflow switch or tamper switch.

Initiating Device Circuit (IDC). A circuit to which initiating devices are connected.

Labeled. Equipment or materials to which have been attached a label, symbol, or other identifying mark of an organization acceptable to the authority having jurisdiction and concerned with product evaluation, that maintains periodic inspection of the production of such labeled equipment or materials. And by whose labeling the manufacturer indicates compliance with appropriate standards or performance in a specified manner.

Listed. Equipment or materials included in a list published by an organization acceptable to the authority having jurisdiction and concerned with product evaluation, that maintains periodic inspection of production of listed equipment or materials. And whose listing states either that the equipment or material meets appropriate standards or has been tested and found suitable for use in a specified manner.

NEC. National Electrical Code also published as NFPA standard 70.

Notification Appliance. An electrically operated appliance used to indicate the system status such as a bell, horn, strobe light or speaker.

Notification Appliance Circuit (NAC). A circuit to which notification appliances are connected.

Power Supply. That portion of the fire alarm control panel, which provides the power needed to operate all control panel modules, as well as that, needed to operate all electrically powered initiating devices and all notification appliances.

Programming Tool. Refers to an external proprietary software package that allows the user to program the panel (FXS360 for the FC901 panel).

Quick Test. A term pertaining to the test mode of the system, that automatically resets after a service technician tests initiating devices.

Reset Condition. Condition in which the panel is forced to return to its normal state, usually performed by pressing the "SYSTEM RESET" button after all known events / conditions are cleared.

Supervisory. A signal indicating the operation of a supervisory device.

Supervisory Device. A device that monitors the condition of a sprinkler system such as a gate-valve switch, water-level switch, low pressure switch, low temperature switch or fire pump monitor.

Trouble Signal. An audible signal indicating trouble of any nature, such as a circuit break or ground, occurring in the device or wiring associated with a fire alarm signal.

Waterflow Switch. An assembly approved for service and so constructed and installed that any flow of water from a sprinkler system equal to or greater than that from a single automatic sprinkler head will result in activation of this switch and subsequent indication of an alarm condition.

Zone. A designated area of a building. Commonly, zone, is interchanged with initiating device circuit.

Serial interface circuit. Circuit connect to annunciator.

Signaling line circuit. Circuit connect to field devices.

Beijing Siemens Cerberus Electronics Limited
No.1,Fengzhidonglu, Xibeiwang, HaiDian District,
Beijing, 100094, China
Tel: +10 6476 8806
Fax: +10 6476 8899

© 2011 Copyright by
Beijing Siemens Cerberus Electronics Ltd.
Data and design subject to change without notice.