

Honeywell



6820 / 6820EVS

Addressable Fire System
Emergency Voice System
Installation and Operation Guide

Document: LS10144-001SK-E Rev: B

ECN: 17-0491

Fire Alarm & Emergency Communication System Limitations

While a life safety system may lower insurance rates, it is not a substitute for life and property insurance!

An automatic fire alarm system—typically made up of smoke detectors, heat detectors, manual pull stations, audible warning devices, and a fire alarm control panel (FACP) with remote notification capability—can provide early warning of a developing fire. Such a system, however, does not assure protection against property damage or loss of life resulting from a fire.

An emergency communication system—typically made up of an automatic fire alarm system (as described above) and a life safety communication system that may include an autonomous control unit (ACU), local operating console (LOC), voice communication, and other various inter-operable communication methods—can broadcast a mass notification message. Such a system, however, does not assure protection against property damage or loss of life resulting from a fire or life safety event.

The Manufacturer recommends that smoke and/or heat detectors be located throughout a protected premises following the recommendations of the current edition of the National Fire Protection Association Standard 72 (NFPA 72), manufacturer's recommendations, State and local codes, and the recommendations contained in the Guide for Proper Use of System Smoke Detectors, which is made available at no charge to all installing dealers. This document can be found at <http://www.systemsensor.com/appguides/>. A study by the Federal Emergency Management Agency (an agency of the United States government) indicated that smoke detectors may not go off in as many as 35% of all fires. While fire alarm systems are designed to provide early warning against fire, they do not guarantee warning or protection against fire. A fire alarm system may not provide timely or adequate warning, or simply may not function, for a variety of reasons:

Smoke detectors may not sense fire where smoke cannot reach the detectors such as in chimneys, in or behind walls, on roofs, or on the other side of closed doors. Smoke detectors also may not sense a fire on another level or floor of a building. A second-floor detector, for example, may not sense a first-floor or basement fire.

Particles of combustion or "smoke" from a developing fire may not reach the sensing chambers of smoke detectors because:

- Barriers such as closed or partially closed doors, walls, chimneys, even wet or humid areas may inhibit particle or smoke flow.
- Smoke particles may become "cold," stratify, and not reach the ceiling or upper walls where detectors are located.
- Smoke particles may be blown away from detectors by air outlets, such as air conditioning vents.
- Smoke particles may be drawn into air returns before reaching the detector.

The amount of "smoke" present may be insufficient to alarm smoke detectors. Smoke detectors are designed to alarm at various levels of smoke density. If such density levels are not created by a developing fire at the location of detectors, the detectors will not go into alarm.

Smoke detectors, even when working properly, have sensing limitations. Detectors that have photoelectronic sensing chambers tend to detect smoldering fires better than flaming fires, which have little visible smoke. Detectors that have ionizing-type sensing chambers tend to detect fast-flaming fires better than smoldering fires. Because fires develop in different ways and are often unpredictable in their growth, neither type of detector is necessarily best and a given type of detector may not provide adequate warning of a fire.

Smoke detectors cannot be expected to provide adequate warning of fires caused by arson, children playing with matches (especially in bedrooms), smoking in bed, and violent explo-

sions (caused by escaping gas, improper storage of flammable materials, etc.).

Heat detectors do not sense particles of combustion and alarm only when heat on their sensors increases at a predetermined rate or reaches a predetermined level. Rate-of-rise heat detectors may be subject to reduced sensitivity over time. For this reason, the rate-of-rise feature of each detector should be tested at least once per year by a qualified fire protection specialist. Heat detectors are designed to protect property, not life.

IMPORTANT! Smoke detectors must be installed in the same room as the control panel and in rooms used by the system for the connection of alarm transmission wiring, communications, signaling, and/or power. If detectors are not so located, a developing fire may damage the alarm system, compromising its ability to report a fire.

Audible warning devices such as bells, horns, strobes, speakers and displays may not alert people if these devices are located on the other side of closed or partly open doors or are located on another floor of a building. Any warning device may fail to alert people with a disability or those who have recently consumed drugs, alcohol, or medication. Please note that:

- An emergency communication system may take priority over a fire alarm system in the event of a life safety emergency.
- Voice messaging systems must be designed to meet intelligibility requirements as defined by NFPA, local codes, and Authorities Having Jurisdiction (AHJ).
- Language and instructional requirements must be clearly disseminated on any local displays.
- Strobes can, under certain circumstances, cause seizures in people with conditions such as epilepsy.
- Studies have shown that certain people, even when they hear a fire alarm signal, do not respond to or comprehend the meaning of the signal. Audible devices, such as horns and bells, can have different tonal patterns and frequencies. It is the property owner's responsibility to conduct fire drills and other training exercises to make people aware of fire alarm signals and instruct them on the proper reaction to alarm signals.
- In rare instances, the sounding of a warning device can cause temporary or permanent hearing loss.

A life safety system will not operate without any electrical power. If AC power fails, the system will operate from standby batteries only for a specified time and only if the batteries have been properly maintained and replaced regularly.

Equipment used in the system may not be technically compatible with the control panel. It is essential to use only equipment listed for service with your control panel.

Telephone lines needed to transmit alarm signals from a premises to a central monitoring station may be out of service or temporarily disabled. For added protection against telephone line failure, backup radio transmission systems are recommended.

The most common cause of life safety system malfunction is inadequate maintenance. To keep the entire life safety system in excellent working order, ongoing maintenance is required per the manufacturer's recommendations, and UL and NFPA standards. At a minimum, the requirements of NFPA 72 shall be followed. Environments with large amounts of dust, dirt, or high air velocity require more frequent maintenance. A maintenance agreement should be arranged through the local manufacturer's representative. Maintenance should be scheduled monthly or as required by National and/or local fire codes and should be performed by authorized professional life safety system installers only. Adequate written records of all inspections

Installation Precautions

Adherence to the following will aid in problem-free installation with long-term reliability:

WARNING - Several different sources of power can be connected to the fire alarm control panel. Disconnect all sources of power before servicing. Control unit and associated equipment may be damaged by removing and/or inserting cards, modules, or interconnecting cables while the unit is energized. Do not attempt to install, service, or operate this unit until manuals are read and understood.

CAUTION - System Re-acceptance Test after Software Changes: To ensure proper system operation, this product must be tested in accordance with NFPA 72 after any programming operation or change in site-specific software. Re-acceptance testing is required after any change, addition or deletion of system components, or after any modification, repair or adjustment to system hardware or wiring. All components, circuits, system operations, or software functions known to be affected by a change must be 100% tested. In addition, to ensure that other operations are not inadvertently affected, at least 10% of initiating devices that are not directly affected by the change, up to a maximum of 50 devices, must also be tested and proper system operation verified.

This system meets NFPA requirements for operation at 0-49° C/32-120° F and at a relative humidity. However, the useful life of the system's standby batteries and the electronic components may be adversely affected by extreme temperature ranges and humidity. Therefore, it is recommended that this system and its peripherals be installed in an environment with a normal room temperature of 15-27° C/60-80° F.

Verify that wire sizes are adequate for all initiating and indicating device loops. Most devices cannot tolerate more than a 10% I.R. drop from the specified device voltage.

Like all solid state electronic devices, this system may operate erratically or can be damaged when subjected to lightning induced transients. Although no system is completely immune from lightning transients and interference, proper grounding will reduce susceptibility. Overhead or outside aerial wiring is not recommended, due to an increased susceptibility to nearby lightning strikes. Consult with the Technical Services Department if any problems are anticipated or encountered.

Disconnect AC power and batteries prior to removing or inserting circuit boards. Failure to do so can damage circuits.

Remove all electronic assemblies prior to any drilling, filing, reaming, or punching of the enclosure. When possible, make all cable entries from the sides or rear. Before making modifications, verify that they will not interfere with battery, transformer, or printed circuit board location.

Do not tighten screw terminals more than 9 in-lbs. Overtightening may damage threads, resulting in reduced terminal contact pressure and difficulty with screw terminal removal.

This system contains static-sensitive components.

Always ground yourself with a proper wrist strap before handling any circuits so that static charges are removed from the body. Use static suppressive packaging to protect electronic assemblies removed from the unit.

Follow the instructions in the installation, operating, and programming manuals. These instructions must be followed to avoid damage to the control panel and associated equipment. FACP operation and reliability depend upon proper installation.

Precau-D1-9-2005

Documentation Feedback

Your feedback helps us keep our documentation up-to-date and accurate. If you have a question or encounter a problem not covered in this manual, contact Honeywell Silent Knight Technical Support at 800-446-6444.

Please give the following information:

- Product name and version number (if applicable)
- Printed manual
- Topic Title
- Page number (for printed manual)
- Brief description of content you think should be improved or corrected
- Your suggestion for how to correct/improve documentation

To order parts, contact Honeywell Silent Knight customer service at 800-328-0103.

Contents

Section 1

Introduction 1

- 1.1 Overview of Basic System 1
 - 1.1.1 Addressable Fire Alarm Control/Communicator Hardware Features 1
 - 1.1.2 Common Communication / Annunciation Link System Hardware Features 1
 - 1.1.3 Software Features 2
 - 1.1.4 6820EVS Features 2
- 1.2 About this Manual 2
 - 1.2.1 Terms Used in this Manual 2
- 1.3 Compatible Products 3

Section 2

Agency Listings, Approvals, and Requirements 1

- 2.1 Federal Communications Commission (FCC) 1
- 2.2 Underwriters Laboratories (UL) 2
 - 2.2.1 Requirements for All Installations 2
 - 2.2.2 Requirements for Central Station Fire Alarm Systems 3
 - 2.2.3 Requirements for Local Protected Fire Alarm Systems 3
 - 2.2.4 Requirements for Remote Station Protected Fire Alarm Systems 3
 - 2.2.5 Requirements for the Installation of Carbon Monoxide (CO) Detection and Warning Equipment, NFPA 720 3
 - 2.2.6 NFPA Requirements 3

Section 3

Before You Begin Installation 1

- 3.1 Inventory 1
- 3.2 Environmental Specifications 1
- 3.3 Software Downloads 1
- 3.4 Electrical Specifications 2
- 3.5 Wiring Specifications 3
- 3.6 Board Assembly Diagram 5
- 3.7 Calculating Current Draw and Standby Battery 6
 - 3.7.1 Current Draw Worksheet Requirements 6
 - 3.7.2 Current Draw Worksheet for SK SLC Devices 6
 - 3.7.3 Current Draw Worksheet for SD SLC Devices 10
 - 3.7.4 Maximum Battery Standby Load 12

Section 4

Control Panel Installation 1

- 4.1 Mounting the Control Panel Cabinet 1

4.1.1	Preventing Water Damage	1
4.1.2	Removing the 6820 / 6820EVS Assembly from the Housing	1
4.1.3	Ethernet Connection	2
4.2	AC Connection	2
4.3	Battery Power	3
4.3.1	Battery Accessory Cabinet	3
4.3.1.1	Installing the RBB Accessory Cabinet and Batteries	3
4.4	SBUS Wiring	5
4.4.1	Calculating Wiring Distance for SBUS Modules	5
4.4.2	Wiring Configurations	8
4.5	5860 Remote Annunciator Installation	9
4.5.1	Mounting the 5860	9
4.5.1.1	Flush Mounting	11
4.5.1.2	Surface Mounting	12
4.5.2	Model 5860 Connection to the Panel	12
4.6	6855 Remote Annunciator Installation	13
4.6.1	Mounting the 6855	13
4.6.1.1	Flush Mounting	14
4.6.1.2	Surface Mounting	15
4.6.2	Model 6855 Connection to the Panel	16
4.7	6860 Remote Annunciator Installation	16
4.7.1	Mounting the 6860	17
4.7.1.1	Flush Mounting	17
4.7.1.2	Surface Mounting	18
4.7.2	6860 Connection to the Panel	20
4.8	5815XL Installation	20
4.8.1	5815XL Connection to the Panel	21
4.9	6815 Installation	22
4.9.1	6815 Connection to the Panel	22
4.10	5824 Serial/Parallel Interface Module Installation	24
4.10.1	Selecting 5824 Options	24
4.11	5880 LED I/O Module	25
4.11.1	5880 Board Layout	25
4.11.2	5880 Connection to Panel	26
4.11.3	LED Wiring	27
4.11.4	Dry Contact Wiring	28
4.12	5865-3 / 5865-4 LED Annunciator Installation	29
4.12.1	5865 Connection to Panel	29
4.12.2	5865 Mounting	30
4.13	Configuring SBUS Modules	31
4.13.1	Assigning SBUS Module IDs	31
4.13.2	SBUS Bandwidth Considerations	31
4.14	Telephone Connection	32
4.15	Flexputs™ I/O Circuits	32
4.15.1	Conventional Input Switch Circuits	32
4.15.1.1	Class B Inputs	32
4.15.2	Class A Inputs	33
4.15.3	Installing 2-Wire Smoke Detectors	34
4.15.3.1	Installing 2-Wire Class B Smoke Detectors	34
4.15.3.2	Installing 2-Wire Class A Smoke Detectors	34
4.15.4	Installing 4-Wire Smoke Detectors	35
4.15.4.1	Installing 4-Wire Class B Smoke Detectors	35
4.15.4.2	Installing 4-Wire Class A Smoke Detectors	35
4.16	Conventional Notification Appliance	37

- 4.16.1 Class B Notification Wiring37
- 4.16.2 Class A Notification Wiring38
- 4.16.3 Auxiliary Power Installation38
 - 4.16.3.1 Door Holder Power39
 - 4.16.3.2 Constant Power39
 - 4.16.3.3 Resettable Power39
 - 4.16.3.4 Sounder Sync Power39
- 4.17 On-Board Relays (Conventional)39
 - 4.17.1 Trouble Relay39
 - 4.17.2 Programmable Relays40
- 4.18 Remote Station Applications40
 - 4.18.1 Keltron Model 3158 Installation40
 - 4.18.2 City Box Connection Using the 5220 Module41
 - 4.18.3 Using the Addressable Relay Module for City Box Connection42
 - 4.18.4 NFPA 72 Polarity Reversal42
 - 4.18.4.1 Using the 5220 Module42
 - 4.18.4.2 Using the 7644-L8 Module43
 - 4.18.5 Transmitter Activated by Dry Contacts44

Section 5

Common Communication Link1

- 5.1 Hardware Features1
 - 5.1.1 Panels1
 - 5.1.2 Wiring Options to Connect Panels1
- 5.2 SK-NIC Connection Options2
- 5.3 SK-NIC Wiring Options3
 - 5.3.1 Fiber Loop Modules3
 - 5.3.1.1 SK-NIC-KIT Mounting Kit4
 - 5.3.2 SK-NIC Installation4
 - 5.3.2.1 Unshielded Twisted Pair Wiring between Multiple Panels6
 - 5.3.2.2 Fiber Optic Multi-Mode Wiring between Multiple Panels7
 - 5.3.2.3 Fiber Optic and Twisted Pair Wiring between Multiple Panels9
- 5.4 Setting the Panel ID for each Panel10

Section 6

Network Management1

- 6.1 Network Diagnostics1
 - 6.1.1 Ping Panel1
 - 6.1.2 Data Network Status1
- 6.2 Network Programming1
 - 6.2.1 Learn Network1
 - 6.2.2 Edit Network Names2
 - 6.2.3 Edit Panel ID2
 - 6.2.4 Computer Access2
 - 6.2.5 Access Codes3
 - 6.2.5.1 Edit Name4
 - 6.2.5.2 Edit Access Code4
 - 6.2.5.3 Panel Functions4
 - 6.2.6 Communicator Options4

6.2.6.1	Communicator Assignments	4
6.2.6.2	Communicator Miscellaneous	5
6.2.6.3	Receiver Configuration	5
6.2.6.4	Communicator Reporting Table	5
6.3	Voice Options	6
6.3.1	Edit Timers	6
6.3.1.1	Control Lockout	6
6.3.1.2	Auto Reset EVS MIC Triggered Event	6
6.3.2	Edit Voice Commands	7
6.4	Sync Network Options	9

Section 7

SK, SD and SWIFT™ Wireless SLC Device Installation 1

7.1	List of SK SLC Devices	1
7.2	List of SD SLC Devices	2
7.3	SWIFT Wireless SLC Devices	3
7.4	Maximum Number of Devices	3
7.5	Wiring Requirements for SLC Devices	3
7.5.1	Wire Sizing on 5815XL for SD Devices	3
7.5.2	Wire Sizing for 6815	4
7.5.3	SK Modules	4
7.5.4	Wiring 5815XL or 6815 in Class A Configuration	6
7.6	Wiring SK SLC Detectors	6
7.7	Addressing SK SLC Devices	7
7.8	Wiring SD SLC Detectors	7
7.9	Addressing SD SLC Devices	8
7.9.1	SLC Devices with DIP Switches	9
7.10	SK-WGI Wireless Gateway	10
7.10.1	Power Connections for the Gateway	10

Section 8

Programming Overview 1

8.1	JumpStart® Autoprogramming	1
8.1.1	Input Points	1
8.1.2	Output Points	1
8.1.3	Running JumpStart® AutoProgramming	2
8.2	Mapping Overview	4
8.2.1	Input Point Mapping	5
8.2.2	Output Circuit Mapping	6
8.2.3	Event Mapping	7
8.2.4	Mapping LED Points	10
8.3	Programming Using the HFSS Software Suite	10
8.4	Programming Using an Annunciator	11
8.4.1	Entering / Exiting the Program Menu	11
8.4.1.1	Moving through the Menus	11
8.4.1.2	Selecting Options and Entering Data	11
8.5	Programming Menu Quick Reference	12

Section 9 Programming 1

- 9.1 UL 864 / UL 2572 Programming Requirements 1
- 9.2 Modules 2
 - 9.2.1 Edit Modules 2
 - 9.2.1.1 Editing Module ID 2
 - 9.2.1.2 Naming Modules 2
 - 9.2.1.3 Changing Module Options 2
 - 9.2.2 Adding a Module 3
 - 9.2.3 Deleting a Module 3
 - 9.2.4 View Module List 3
- 9.3 Zone 4
 - 9.3.1 Edit Zone 4
 - 9.3.1.1 Edit Zone Name 4
 - 9.3.1.2 Edit Zone Properties 4
 - 9.3.1.3 Zone Accessory Options 6
 - 9.3.2 View Zone Points 6
- 9.4 Group 6
 - 9.4.1 Edit Group 6
 - 9.4.1.1 Edit Group Name 7
 - 9.4.1.2 Edit Group Properties 7
 - 9.4.2 View Group Points 8
 - 9.4.3 Edit OPG Template 9
- 9.5 Point 10
 - 9.5.1 Point Programming For 5815XL Module 10
 - 9.5.2 Point Programming For 6815 Module 12
 - 9.5.3 Point Programming For Internal or External Power Module 15
 - 9.5.4 Point Programming For 5880, 5865, EVS-50W, EVS-INT50W, EVS-100W, EVS-125W and EVS-CE4 Modules 17
 - 9.5.5 Point Programming For EVS-VCM and EVS-RVM Modules 17
- 9.6 System Options 18
 - 9.6.1 Communication Options 18
 - 9.6.1.1 Auto Test Time 18
 - 9.6.1.2 Phone Lines 19
 - 9.6.1.3 Edit Ethernet 21
 - 9.6.1.4 AlarmNet Timers 21
 - 9.6.1.5 Phone Line Gains 21
 - 9.6.2 Time Options 22
 - 9.6.2.1 Water Flow Delay 22
 - 9.6.2.2 Alarm Verify 22
 - 9.6.2.3 AC Report Delay 22
 - 9.6.2.4 Change AC Line Frequency 23
 - 9.6.2.5 Clock Display Format (AM/PM or Military) 23
 - 9.6.2.6 Auto-Resound (4 or 24 hours) 23
 - 9.6.3 Miscellaneous Options 23
 - 9.6.3.1 Synchronize Strobes Active During Silence 23
 - 9.6.3.2 Auto Display Event 23
 - 9.6.4 Daylight Savings Options 24
 - 9.6.4.1 Automatic Daylight Savings Adjustment 24
 - 9.6.4.2 Daylight Saving Time Start and End 24
 - 9.6.5 Edit Banner 24

9.6.6 SLC Family	25
9.7 JumpStart® AutoProgramming	25
9.8 Restore Defaults	25
9.9 VCM Maintenance	26
9.9.1 VCM Maintenance	26

Section 10

System Operation 1

10.1 User and Installer Default Codes	1
10.2 Annunciator Description	1
10.2.1 LCD Display	2
10.2.2 Banner	2
10.3 Menu System	3
10.3.1 Main Menu Overview	3
10.3.2 Using the Menus	4
10.4 Basic Operation	4
10.4.1 Setting Time and Date	4
10.4.2 Disable / Enable a Point	4
10.4.2.1 Disable / Enable NACs by Template	4
10.4.2.2 Disable / Enable NACs by Group	4
10.4.2.3 Disable / Enable Zone Points	4
10.4.2.4 Disable / Enable Point	4
10.4.2.5 Inhibit Output Group	5
10.4.3 View Event History	5
10.4.3.1 To clear the event history	5
10.4.3.2 Single Key Acknowledge	5
10.4.4 Conduct a Fire Drill	5
10.4.5 Conduct an Indicator Test	5
10.4.6 Conduct a Walk Test	6
10.4.7 Conduct a Communicator Test	6
10.4.8 Manual AlarmNet Registration	7
10.4.9 Silence Alarms or Troubles	7
10.4.10 Reset Alarms	7
10.4.10.1 Reset Communicator	7
10.4.11 Check Detector Sensitivity Through Point Status	7
10.4.12 View Status of a Point	9
10.4.13 View Alarms or Troubles	9
10.4.14 System Information	9
10.5 Event Priority	10
10.5.1 System Control	10
10.5.2 System Override	10
10.5.3 Event Priority	11
10.5.4 Priority Rules	12
10.5.5 Other Priority Considerations	12
10.6 Operation Mode Behavior	12
10.6.1 Multi-Site Annunciator and Multi-Site User Access	15
10.7 Releasing Operations	16
10.7.1 Single Interlock Zone Releasing	17
10.7.2 Double Interlock Zone Releasing	18
10.8 Smoke Alarm Verification	19
10.9 Function Keys	20

10.9.1 Recording an F-Key Macro20
 10.9.2 Aborting an F-Key Macro Recording Session20
 10.9.3 Erasing an F-Key Macro20
 10.9.4 Using a Recorded F-Key Macro20
 10.9.5 F-Key Status Event20
 10.9.6 F-Key Map Inhibit21

Section 11

Emergency Voice System Operation 1

11.1 Overview 1
 11.2 LOC Functionality 1
 11.2.1 Keys and LEDs 1
 11.2.1.1 EVS Control Key 1
 11.2.1.2 EVS Control LED 1
 11.2.1.3 EVS Message Keys 2
 11.2.1.4 EVS Message LEDs 2
 11.2.1.5 Select Keys 2
 11.2.1.6 Select Key LEDs 2
 11.2.2 Gaining EVS Control 3
 11.2.2.1 LOC Priority 3
 11.2.2.2 LOC Lockout 3
 11.2.2.3 User Profile Access Control 4
 11.2.3 Manual EVS 4
 11.2.3.1 Switching between Microphone Mode and Message Mode 4
 11.2.3.2 Activating Output Groups Dynamically 4
 11.2.4 Microphone Mode 5
 11.2.5 Message Mode 5
 11.2.6 Custom EVS Event 5
 11.2.7 Passing EVS Control 5
 11.2.8 Exit EVS Control Menu 6
 11.2.9 Relinquish EVS Control 6
 11.2.10 EVS Reset 6
 11.3 EVS Super User 6
 11.4 EVS Point Functionality 7
 11.4.1 EVS Point Activations 7
 11.4.2 EVS-VCM & EVS-RVM Points 7
 11.5 Amplifier Programming 7
 11.5.1 Adding an Amplifier 7
 11.5.2 Editing an Amplifier 8
 11.6 LOC Programming 8
 11.6.1 Adding an LOC 8
 11.6.2 Editing an LOC 8
 11.6.2.1 LOC Priority 9
 11.6.2.2 LOC Association 9
 11.7 Using the Microphone 9
 11.7.1 Microphone Functionality 9
 11.7.2 Custom EVS Event 9
 11.7.3 Fire Page 9
 11.7.4 Emergency Page 10
 11.7.5 Paging 10
 11.8 Recording Custom Messages 11

11.8.1 Recording Messages 1-15 Using Aux Audio Input 12
11.8.2 Recording Messages 1-15 Using the Microphone 13
11.8.3 Erasing User Message 14
11.8.4 Using HFSS Voice Message Load Software 15

Section 12
Reporting 1

12.1 Receivers Compatible with the Control Panel 1
12.2 SIA / Panels PI Modifier Reporting: 13
12.3 SIA – Panel Communicator: 14

Section 13
Testing and Troubleshooting 1

13.1 Troubleshooting 1
13.2 Common Problems 1
13.3 Periodic Testing and Maintenance 2
13.4 Event History 3
13.5 Built-in Troubleshooting and Testing Tools 3
 13.5.1 SLC Device Locator 3
 13.5.2 SLC Multiple Locator 4
 13.5.3 I/O Point Control 4
 13.5.4 Earth Fault Resistance 5

Section 14
Installation Records 1

14.1 Detector and Module Point Record 1

Appendix A
Compatible Devices 1

Appendix B
Editing Text Using the Built-In Programmer 1

Appendix C
Expanded Receiver/Panel Relationship 1

Appendix D
Cadence Patterns 1

Honeywell Fire Product Warranty and Return Policy

Manufacturer Warranties and Limitation of Liability

6820 Basic Operating Instructions

6820EVS Basic Operating Instructions

Section 1

Introduction

The 6820 Fire Alarm Control/Communicator is an addressable fire control system that meets the requirements of UL 864.

The 6820EVS integrates an Emergency Voice System that meets the requirements of UL 864 and UL 2572.

1.1 Overview of Basic System

The 6820 and 6820EVS base system is an addressable system with a built-in annunciator that can also be used to program the system.

1.1.1 Addressable Fire Alarm Control/Communicator Hardware Features

- The 6820 and 6820EVS panel contains one built in signaling line circuit (SLC), which supports up to 159 SK sensors and 159 SK modules or 127 SD SLC devices. Additional SLC loops can be added to increase overall point capacity.
- Additional 6815 SLC expanders supports 159 SK sensors and 159 SK modules per loop for a maximum of 1110 points per 6820 or 6820EVS control panel.
- Additional 5815XL SLC expander supports only SD Protocol for a maximum of 635 points per 6820 or 6820EVS control panel.
- 6.0A of output power is available through 6 sets of terminals for notification. Each circuit is power limited per UL 864 and can source up to 3.0A (total output power must not exceed 6.0A). The constant auxiliary power load must not exceed 3.0A max for normal standby.
- Built-in dual phone line, digital alarm communicator/transmitter (DACT), IP or optional cellular technologies.
- Reports events to central station by point or by zone.
- UL Listed for pre-action and deluge releasing systems.
- Dedicated Form C trouble relay and two general purpose Form C programmable relays.
- Basic system operation can be performed using a key or a user code.
- Can be used with up to 16 Model 6860, 5860, or 6855 Remote Annunciators in any combination. (sold separately).
- Supports the 5865-3, 5865-4, and 5880 in any combination for a total of eight devices on one control panel.
- Printing of event log available through the Model 5824 serial/parallel printer interface module.
- Supports conventional 2-wire & 4-wire detectors using the 2 Flexput™ circuits.
- Add six Flexput™ circuits with each 5895XL Intelligent Power Module. See note below.
- Add four notification/auxiliary power circuits with each 5496 Intelligent Power Module. See note below.

Note: The system can support a maximum of 16 Intelligent Power modules, either the 5895XL or 5496, in any combination.

1.1.2 Common Communication / Annunciation Link System Hardware Features

The common communications and annunciation link allows up to 17 of the 6700, 6808, 6820, and 6820EVS panels to be connected via copper or fiber optic cable so that a designated panel is the communicator for all panels in the link. This is not a true peer-to-peer network and will not perform like one.

- The default Common communications link setup can contain up to 17- 6820 / 6820EVS panels connected.
- Common communications link support for up to 17 Sites.
- Each building is referred to as a “site”.
- Panels can be interconnected using CLASS B or CLASS A topology.
- Use the SK-NIC Network Interface Card as a Common communications link. Copper wire or fiber optic cable panel connectivity can be used within the same linked system.
- The common communication and annunciation architecture allows a designated panel to be the communicator for all the panels in the link.

1.1.3 Software Features

- Advanced smoke detector features:
 - Automatic drift compensation
 - Maintenance alert region
 - Point status meets calibrated smoke test requirements for NFPA 72
- “JumpStart” feature for easy programming.
- 999 software zones, 999 output groups.
- Non-volatile event history stores 1000 events.
- A choice of output patterns available for notification outputs, including Temp 4 and ANSI 3.41 temporal signal.
- Built-in synchronization appliance support for AMSECO, Gentex[®], System Sensor[®], and Wheelock.[®]

1.1.4 6820EVS Features

- The EVS-VCM has a built-in Digital Message Repeater.
- 15 EVS messages.
- SBUS addressable amplifier. The system can support a combination of up to four EVS-50W, EVS-125W, EVS-INT50W or EVS-100W amplifiers for a maximum of 500 watts per system.
- On-board supervised microphone.
- 6820 or 6820EVS can support up to four EVS-LOC's (Local Operator Consoles).
- Single enclosure for both Fire and Emergency Control System components.
- Support for one EVS-VCM.

1.2 About this Manual

This manual is intended to be a complete reference for all installation and operation tasks for the 6820* and 6820EVS**. Please let us know if the manual does not meet your needs in any way. We value your feedback!

* All references to 6820 within this manual are applicable to the 6820EVS.

** Further installation instructions for the 6820/EVS and accessories can be found in the EVS Series installation manual P/N LS10062-001-SK-E.

1.2.1 Terms Used in this Manual

The following terminology is used with the above mentioned control panels:

Term	Description
SLC	Signaling line circuit
Module	The term module is used for all hardware devices except for SLC addressable devices and notification appliances. This includes the 6820 or 6820EVS panel itself and the built-in power supply. It also refers to any (optional) 5815XL or 6815 SLC expansion modules.
Input Point	An addressable sensing device, such as a smoke or heat detector or a contact monitor device.
Input Zone	A protected area made up of input points.

Term	Description
Output Point (or "Output Circuit")	A notification point or circuit for notification appliances. Relay circuits and auxiliary power circuits are also considered output points.
Output Group (OPG)	A group of output points. Operating characteristics are common to all output points in the group.
Output (or "Cadence") Pattern	The pattern that the output will use, for example, Constant, March Code, ANSI 3.41. Applies to zones and special system events. See Appendix D for additional information.
Mapping	Mapping is the process of specifying which outputs are activated when certain events occur in the system. Section 8.2 explains mapping in detail.
EVS	Emergency Voice System.
Common Communication Link	Up to 17 panels can be linked. Consist of any combination of 17 panels of these model numbers:6700, 6808, 6820, or 6820EVS. For reporting purposes only. Not a peer-to-peer networked system.
SWIFT	Smart Wireless Integrated Fire Technology

1.3 Compatible Products

Table 1-1 lists the products available from Honeywell Silent Knight for use with the 6820 and 6820EVS.

Table 1-1: 6820 or 6820EVS Compatible Products

Type of Device	Model	Description	
SK Addressable SLC Devices	See Section 7.1 for a list of compatible devices.		
SD Addressable SLC Devices	See Section 7.2 for a list of compatible devices.		
SWIFT Wireless SLC Devices	See Section 7.3 for a list of compatible devices		
Other Modules	5815XL (Rev H or higher) SLC Expander	Allows an additional 127 SD devices to be added to the system for a maximum of 635 points. Supports SD devices only.	
	6815 SLC Expander	Allows an additional 159 SK modules and 159 SK sensors to be added to the system for a maximum of 1110 points. Supports System Sensor SK devices only.	
	5824 Serial/Parallel Printer Interface Module	Allows a printer to be attached for the on-site event logging. Maximum of four 5824s per control panel.	
	5895XL (Rev F or higher) Intelligent Power Module	Provides additional power, six Flexput™ circuits, and two Form C relays. Max. 16 per system see <i>Model 5895XL Installation Instructions P/N 151142</i> .	5895XLs and 5496s can be used in any combination, up to a total of 16 devices on one system.
	5496 (Rev F or higher) Intelligent Power Module	Provides 4 additional Notification Appliance Circuits/ Auxiliary power. (Up to 16 per system).	
	6860 LCD Annunciator	4x40 backlit LCD remote fire annunciator Up to 16 any combination of annunciators per system	up to a total of 16 in any combination on one system.
	5860 LCD Annunciator	4x20 LCD remote fire annunciator. 5860 is gray; 5860R is red.	
	6855 LCD Annunciator	4x20 LCD remote fire annunciator	
	5860TG and 5860TR Trim Ring Kit	Trim ring kits for surface mounting the 5860 annunciator. 5860TG is gray; 5860TR is red.	
	5865-3 and 5865-4 LED Annunciator	LED annunciator can display up to 30 LEDs (15 red and 15 yellow). 5865-4 has key switches for silence and reset, and a system trouble LED.	5865-3, 5865-4, and 5880 can be used in any combination, up to a total of eight devices on one panel.
5880 (Rev C or higher) LED I/O Module	Driver for up to 40 LEDs. Interfaces with customized annunciator boards. In addition, the 5880 has eight generic switch input points.		

Table 1-1: 6820 or 6820EVS Compatible Products

Type of Device	Model	Description		
Other Modules	5883 General Purpose Relay Module	Provides 10 Form C relays. Designed to be driven by the 5880. Up to four, 5883s can be used with each 5880 module.		
	EVS-VCM	Voice Control Module	For use with 6820EVS only. Refer to the <i>EVS-Series Installation Manual</i> P/N LS10062-001SK-E for more information on these accessories.	
	EVS-SW24	24 switch expander		
	EVS-50W	50 watt audio amplifier		
	EVS-125W	125 watt audio amplifier		
	EVS-100W	50/100 watt Intelligent amplifier		
	EVS-100WBU	Backup daughter card		
	EVS-CE4	Provides 4 additional audio circuits for the EVS-50W or EVS-125W.		
	EVS-RVM	Remote Voice Microphone used with the 6820EVS. Max 4		
	EVS-INT50W	50 watt Internal amplifier	Refer to LS10172-001SK-E	
	SK-NIC	Network Interface Card		
	SK-FML	Fiber-Optic Multi Mode, Receiver		Refer to LS10178-001SK-E
	SK-FSL	Fiber-Optic Single Mode, Transmitter		
	EVS-LOC	Local Operating Console	Refer to LS10189-001SK-E	
Wireless	WSK-WGI	Wireless Gateway	LS10036-000SK-E	
	WSK-PHOTO	Wireless photo with 4" base		
	WSK-PHOTO-T	Wireless Multi criteria photoelectric smoke detector with thermal (135°F) with 4" base		
	WSK-HEAT-ROR	Wireless heat, ROR/ 135° fixed with 4" base		
	WSK-HEAT	Wireless Heat, 135° fixed with 4" base		
	WSK-MONITOR	Wireless monitor module		
	WSK-RELAY	Wireless relay module		
	B210W	6" wireless base		
Misc.	7860 Telephone Cord	RJ31X cord for connecting phone line to the 6820/EVS.		
	HFSS Honeywell Fire Software Suite	For communication and panel programming with a Windows-based computer. Enables remote viewing of detector status and event history.		
	RBB	Remote Battery Box for mounting backup batteries that are too large to fit into the main FACP cabinet. Dimensions are 16" W x 10" H x 6" D (40.64 cm W x 25.4 cm H x 15.24 cm D)		
	CELL-MOD	Cellular board with Plastic Enclosure	Refer to LS10182-001SK-E	
	CELL-CAB-SK	Cellular board with Metal Enclosure, lock & key		

Section 2

Agency Listings, Approvals, and Requirements

2.1 Federal Communications Commission (FCC)

- The following information must be provided to the telephone company before the 6820 or 6820EVS can be connected to the phone lines:

A	Manufacturer:	Honeywell Silent Knight
B	Model Number:	6820 and 6820EVS
C	FCC registration number:	US: HS9AL10A2100
	Ringer equivalence:	1.0A
D	Type of jack:	RJ31X
E	Facility Interface Codes:	Loop Start: 02LS2
F	Service Order Code:	9.0F

This equipment complies with Part 68 of the FCC rules and the requirements adopted by ACTA. On the inside cover of this equipment is a label that contains, among other information, a product identifier. If requested, this information must be provided to the telephone company.

A plug and jack used to connect this equipment to the premises wiring and telephone network must comply with the applicable FCC Part 68 rules and requirements adopted by the ACTA. A compliant telephone cord (not provided) and modular jack must be utilized with this product. It is designed to be used with a modular jack that is also compliant.

The REN (ringer equivalence number) provided on this installation sheet is used to determine the number of devices that may be connected to the public switched telephone network. This number must not exceed 5.0. Since this product has an REN of 1.0A, the number of devices is limited. The REN number is embedded in the FCC registration number as 10A.

If the 6820 or 6820EVS causes harm to the telephone network, the telephone company will notify you in advance that the temporarily discontinuance of service may be required. But if advance notice is not practical, the telephone company will notify the customer as soon as possible. Also, you will be advised of your right to file a complaint with the FCC if you believe it is necessary.

The telephone company may make changes in its facilities, equipment, operations or procedures that could affect the operation of the equipment. If this happens the telephone company will provide advance notice in order for you to make necessary modifications to maintain uninterrupted service.

If trouble is experienced with the 6820 or 6820EVS, for repair or warranty information, please contact Honeywell Silent Knight at 1-800-328-0103 or www.silentknight.com. If the equipment is causing harm to the telephone network, the telephone company may request that you disconnect the 6820 or 6820EVS until the problem has been resolved.

This product cannot be adjusted or repaired in the field. It must be returned to the factory for service.

This equipment is not designed for use with party line service. Connection to party line service is subject to state tariffs. You may contact the state public utility commission, public service commission or corporation commission for information.

Since the 6820/6820EVS is a commercial fire alarm panel, it must be connected upstream of all other equipment utilizing the phone lines. If you have questions about the installation, contact your telephone company or a

qualified installer.

Warning

This device has been verified to comply with FCC Rules Part 15. Operation is subject to the following conditions: (1) This device may not cause radio interference, and (2) This device must accept any interference received, including interference that may cause undesired operation.

Caution - To ensure proper operation, this equipment must be installed according to the enclosed installation instructions. To verify that the equipment is operating properly and can successfully report an alarm, this equipment must be tested immediately after installation, and periodically thereafter, according to the enclosed test instructions.

Caution - In order for “alarm dialing equipment” to be able to seize the phone line to report an alarm or other event when other customer equipment (telephone, answering system, computer modem, etc.) connected to the same line is in use, “alarm dialing equipment” must be connected to a properly installed RJ31X jack. The RJ31X jack must be connected in series with, and ahead of, all other equipment attached to the same phone line. Series installation of an RJ31X jack is depicted in the figure below. If you have any questions concerning these instructions, you should consult your telephone company or a qualified installer about installing the necessary jack and alarm dialing equipment for you.

2.2 Underwriters Laboratories (UL)

2.2.1 Requirements for All Installations

General requirements are described in this section. When installing an individual device, refer to the specific section of the manual for additional requirements. The following subsections list specific requirements for each type of installation (for example, Central Station Fire Alarm systems, Local Protected Fire Alarm systems, and so on). See Section 10.7 for information on releasing operation.

1. All field wiring must be installed in accordance with NFPA 70 National Electric Code.
2. Use the addressable smoke detectors specified in Section 7.2 (SD devices) or Section 7.1 (SK devices) of this manual and/or conventional detectors listed in the compatibility chart. (See Appendix A).
3. Use UL listed notification appliances compatible with the 6820 or 6820EVS from those specified in *Appendix A* of this manual.
4. A full system checkout must be performed any time the panel is programmed.

Restricted Options:

- The loss of AC signal is defaulted to 3 hours, however the system allows settings from 0 - 30 hours. For UL certified installations this number must be set from 1 to 3 hours.
- The system allows the use of non-latching spot type smoke detectors. This feature may not be used in commercial applications whereby a general alarm is sounded. It is intended for elevator recall, door holding applications, and hotel/motel room applications.
- The system allows the Alarm Verification time to be set from 60 to 250 seconds. For UL certified installations the setting must be a minimum of 60 seconds.
- The systems allows the Auto-resound time to be set to 24 or 4 hours. For UL certified installations that are utilizing SWIFT devices, the value must be set to 4 hours.
- Call forwarding shall not be used.
- When two count is used: detector spacing shall be cut in half, you shall not use the alarm verification feature, and no delay shall be used.
- P.A.S. (positive alarm sequence) feature shall be used only with automatic detectors.

2.2.2 Requirements for Central Station Fire Alarm Systems

1. Use both phone lines. Enable phone line monitors for both lines.
2. You must program a phone number and a test time so that the 6820/6820EVS shall automatically initiate and complete a test signal transmission sequence to its associated receiver at least once every 6 hrs.
3. The AC Loss Hours option must be set from 1-3 hours.
4. If using wired Ethernet or cellular, you must program the corresponding account/subscriber ID and a test time so that the FACP shall automatically initiate a test signal transmission sequence to its associated receiver at least once every 6 hrs.

2.2.3 Requirements for Local Protected Fire Alarm Systems

At least one UL listed supervised notification appliance must be used.

2.2.4 Requirements for Remote Station Protected Fire Alarm Systems

1. Do not exceed the current draw load restrictions shown in Section 3.7.
2. The AC Loss Hours option must be set from 1-3 hours.

2.2.5 Requirements for the Installation of Carbon Monoxide (CO) Detection and Warning Equipment, NFPA 720

When using carbon monoxide detection the system must be monitored by a Supervising Station.

2.2.6 NFPA Requirements

The following is the minimum configuration to meet the NFPA requirements.

Table 2-1 NFPA Requirements for 6820

Model/Module	Description	Local	Releasing	Remote Station	Auxiliary	Central Station	Emergency Signaling
068200CB	Enclosure	Y	Y	Y	Y	Y	Y
068080	Motherboard	Y	Y	Y	Y	Y	Y
RA-100BD	4 x20 display	Y	Y	Y	Y	Y	Y
5815XL	SLC Expander	O	O	O	O	O	O
6815	SLC Expander	O	O	O	O	O	O
SK-NIC	Network card	O	O	O	O	O	O
SK-FML/ -FSL	Fiber module	O	O	O	O	O	O
7644	Pol Rev device	N	N	Y	N	N	N
5220	City tie, Pol. Rev Device	N	N	Y	Y	N	N
Keltron 3158	Rev Pol Module	N	N	Y	Y	N	N
Cell-Mod/Cell-Cab-SK ¹	Cellular transmitter	N	N		N	Y	N

Table 2-1 NFPA Requirements for 6820

Model/Module	Description	Local	Releasing	Remote Station	Auxiliary	Central Station	Emergency Signaling
Y = YES, N = NO, O = OPTIONAL 1. When configured for Emergency relocation and evacuation equipment the system must meet Local configuration (Model 6820EVS) with a minimum of one amplifier (EVS-50W/EVS-125W or EVS-INT50W) and one Voice Control Module (Model EVS-VCM).							

Table 2-2: NFPA Requirements for 6820EVS

Model/Module	Description	CS	Local	Auxiliary	Remote Station	EVAC ⁵	Mass Notification (In-Building) ⁵
068200	Motherboard	Y	Y	Y	Y	Y	Y
RA-100BD	Control unit operator interface	Y	Y	Y	Y	Y	Y
00VIP-50CB	Amplifier Enclosure	O	O	O	O	Y	O
00VIP-125CB	Amplifier Enclosure	O	O	O	O	Y	O
122774	Control unit enclosure	Y	Y	Y	Y	Y	Y
VIP/EVS-50W	50W Amp ¹	O	O	O	O	Y	YO
VIP/EVS-50WHV	50W Amp ¹	O	O	O	O	Y	Y
EVS-125W	125W amp ¹	O	O	O	O	Y	Y
EVS-125HV/VIP-125HV	125W Amp ¹	O	O	O	O	Y	Y
EVS-INT50W	Internal 50W ¹ Amp	O	O	O	O	Y	Y
EVS-VCM	Voice Control Module ²	O	O	O	O	Y	O
VIP-SW16	Switch annunciator	O	O	O	O	O	O
EVS-SW24	Switch annunciator	O	O	O	O	O	Y
EVS-CE4	Speaker expander mod ³	O	O	O	O	O	O
VIP-RM / EVS-RVM	Remote Microphone Module ⁴	O	O	O	O	O	O
5815XL	SLC Expander	O	O	O	O	O	O
6815	SLC Expander	O	O	O	O	O	O
ECS-NVCM	Network Voice Card	O	O	O	O	O	O
SK-NIC	Network Card	O	O	O	O	O	O
SK-FML / -FSL	Fiber Module	O	O	O	O	O	O

Table 2-2: NFPA Requirements for 6820EVS

Model/Module	Description	CS	Local	Auxiliary	Remote Station	EVAC ⁵	Mass Notification (In-Building) ⁵
<p>Y = YES, N = NO, O = OPTIONAL</p> <ol style="list-style-type: none"> 1. A maximum of eight 50/125 Watts Amplifiers for a maximum of 1000 Watts per EVS System. 2. A maximum of one Voice Control Module per EVS System. 3. A maximum of one Speaker Expander Module per Model EVS-50W/EVS-125W. 4. A maximum of two Remote Microphone modules per EVS System. 5. When configured for Emergency relocation and evacuation equipment the system must meet Local configuration (Model 6820EVS) with a minimum of one amplifier (Model EVS-50W/EVS-125W or EVS-INT50W) and one Voice Control Module (Model EVS-VCM). 							

Section 3

Before You Begin Installation

This section of the manual is intended to help you plan your tasks to facilitate a smooth installation. Please read this section thoroughly, especially if you are installing a 6820 or 6820EVS panel for the first time.

3.1 Inventory

When the 6820 or 6820EVS shipment is received, check that all the parts have been included in the shipment. The shipment consist of one of each of the following:

- main circuit board with display
- backbox with door
- plastic bag containing two keys, screws, cables, and ten 4.7K ohm end-of-line resistors
- manual

3.2 Environmental Specifications

It is important to protect the 6820/6820EVS control panel from water. To prevent water damage, the following precautions should be FOLLOWED when installing the units:

- Intended for indoor use in dry locations only
- Do not mount directly on exterior walls, especially masonry walls (condensation)
- Do not mount directly on exterior walls below grade (condensation)
- Protect from plumbing leaks
- Protect from splash caused by sprinkler system inspection ports
- Do not mount in areas with humidity-generating equipment (such as dryers, production machinery)

When selecting a location to mount the 6820/ 6820EVS control panel, the unit should be mounted where it will NOT be exposed to: temperatures outside the range of 0°C-49°C (32°F-120°F) or humidity exceeding 93% noncondensing.

3.3 Software Downloads

In order to supply the latest features and functionality in fire alarm and life safety technology to our customers, we make frequent upgrades to the embedded software in our products. To ensure that you are installing and programming the latest features, we strongly recommend that you download the most current version of software for each product prior to commissioning any system. Contact Technical Support with any questions about software and the appropriate version for a specific application. HFSS Honeywell Fire Software Suite software is available at www.silentknight.com.

3.4 Electrical Specifications

Table 3-1: Terminal Descriptions and Electrical Specification

Terminal Label		Description	Rating		Earth Ground Faults
			Voltage	Current	
L		AC input (hot)	120 VAC, 60 Hz	3.3 A	N/A
		Earth ground	N/A	N/A	N/A
N		AC input (neutral)	120 VAC, 60 Hz	3.3 A	N/A
-	NAC 6	Flexput™ Circuits	24 VDC	3.0A notification and auxiliary power circuits	0Ω
+				100 mA for initiation circuits	
-	NAC 5	Flexput™ Circuits	24 VDC	3.0A notification and auxiliary power circuits	0Ω
+				100 mA for initiation circuits	
-	NAC 4	NAC Circuits	24 VDC	3.0A notification and auxiliary power circuits	0Ω
+					
-	NAC 3	NAC Circuits	24 VDC	3.0A notification and auxiliary power circuits	0Ω
+					
-	NAC 2	NAC Circuits	24 VDC	3.0A notification and auxiliary power circuits	0Ω
+					
-	NAC 1	NAC Circuits	24 VDC	3.0A notification and auxiliary power circuits	0Ω
+					
B	SBUS OUT	SBUS communication	5 VDC	100 mA	0Ω
A					
+		SBUS power	24 VDC	1.0 A	
-					
B	SBUS IN	Used for Class A installations			0Ω
A					
+					
-					
B	EXT. Comm	Cellular Connection	input		0Ω
A					
+				55 mA, 100 mA	
-					
N.C.	RELAY 1	General Purpose Relay 1	24 VDC	2.5 A, resistive	N/A
C					
N.O.	RELAY 2	General Purpose Relay 2	24 VDC	2.5 A, resistive	N/A
N.C.					
C	TROUBLE	Trouble Relay	24 VDC	2.5 A, resistive	N/A
N.O.					

Table 3-1: Terminal Descriptions and Electrical Specification

Terminal Label		Description	Rating		Earth Ground Faults
			Voltage	Current	
SC-	L1	SLC terminals	32 VDC	150 mA	0Ω
SC+	SLC OUT				
SC-		SLC Programming Terminal (-)	32 VDC	150 mA	0Ω
SC+		SLC Programming Terminal (+)	32 VDC	150 mA	
SC-	L2	Used for Class A installations			0Ω
SC+	SLC IN				
Ring		Phone Line 1 Telco Ring	N/A		0Ω
Tip		Phone Line 1 Telco Tip			
Ring		Phone Line 1 Premises Ring			
Tip		Phone Line 1 Premises Tip			
Ring		Phone Line 2 Telco Ring	N/A		0Ω
Tip		Phone Line 2 Telco Tip			
Ring		Phone Line 2 Premises Ring			
Tip		Phone Line 2 Premises Tip			
P7	Data Network	Used for SK-NIC	24 VDC	21 mA	0Ω

3.5 Wiring Specifications

Induced noise (transfer of electrical energy from one wire to another) can interfere with telephone communication or cause false alarms. To avoid induced noise, follow these guidelines:

- Isolate input wiring from high current output and power wiring. Do not pull one multi-conductor cable for the entire panel. Instead, separate the wiring as follows:

High voltage	AC power Terminals
SLC loops	In/Out Terminals
POTS reporting input/output	Phone line circuits, TELCO
Notification circuits	NAC 1-6
SBUS	SBUS1 In/Out Terminals, Cellular communication
Relay circuits	Trouble, Relay 1, Relay 2 Terminals

- Do not pull wires from different groups through the same conduit. If you must run them together, do so for as short a distance as possible or use shielded cable. Connect the shield to earth ground at the panel. You must route high and low voltages separately.
- Route the wiring around the inside perimeter of the cabinet. It should not cross the circuit board where it could induce noise into the sensitive microelectronics or pick up unwanted RF noise from the high speed circuits. See Figure 3-1 for an example.
- High frequency noise, such as that produced by the inductive reactance of a speaker or bell, can also be reduced by running the wire through ferrite shield beads or by wrapping it around a ferrite toroid.

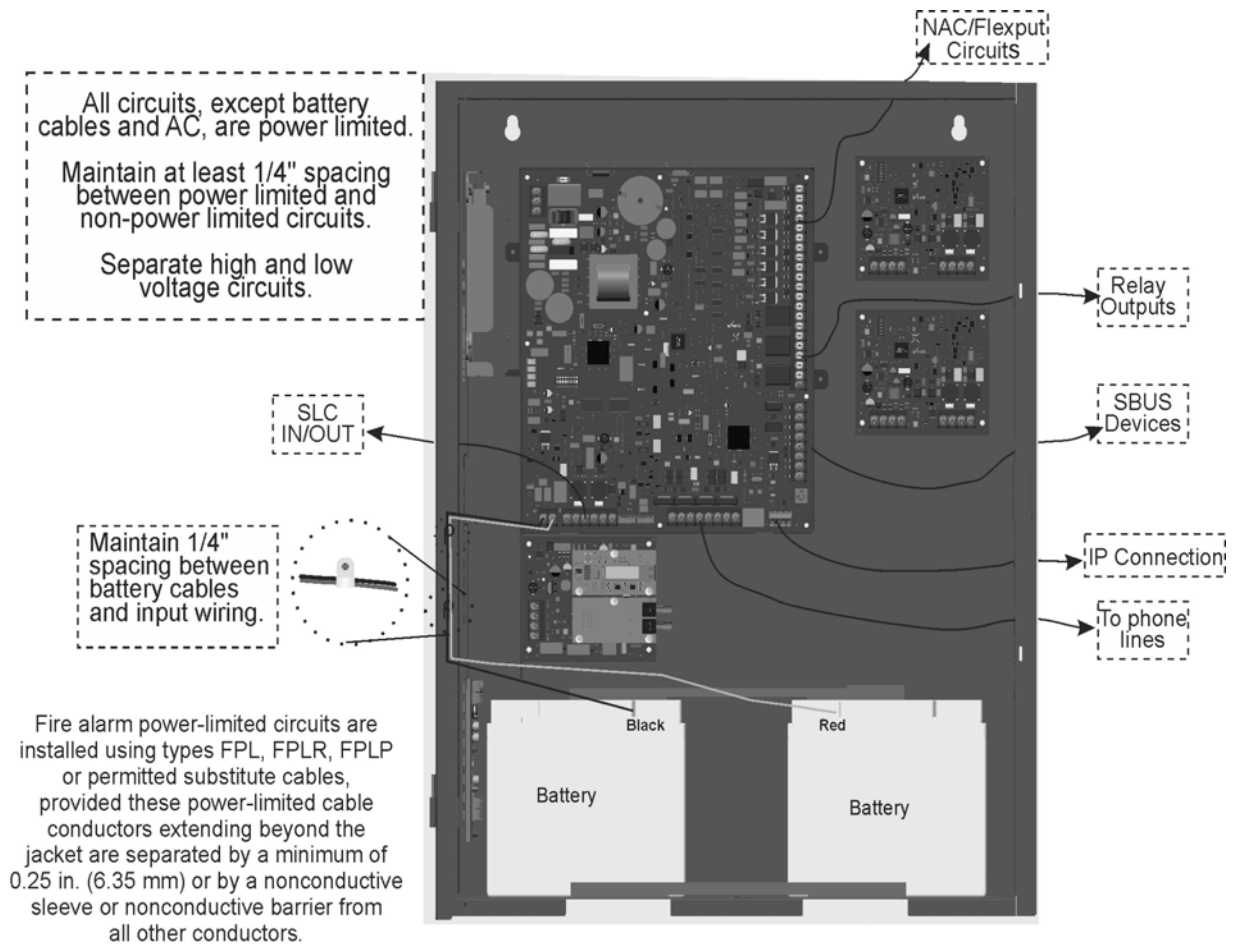

Figure 3-1 Wire Routing Example for 6820/EVS

3.6 Board Assembly Diagram

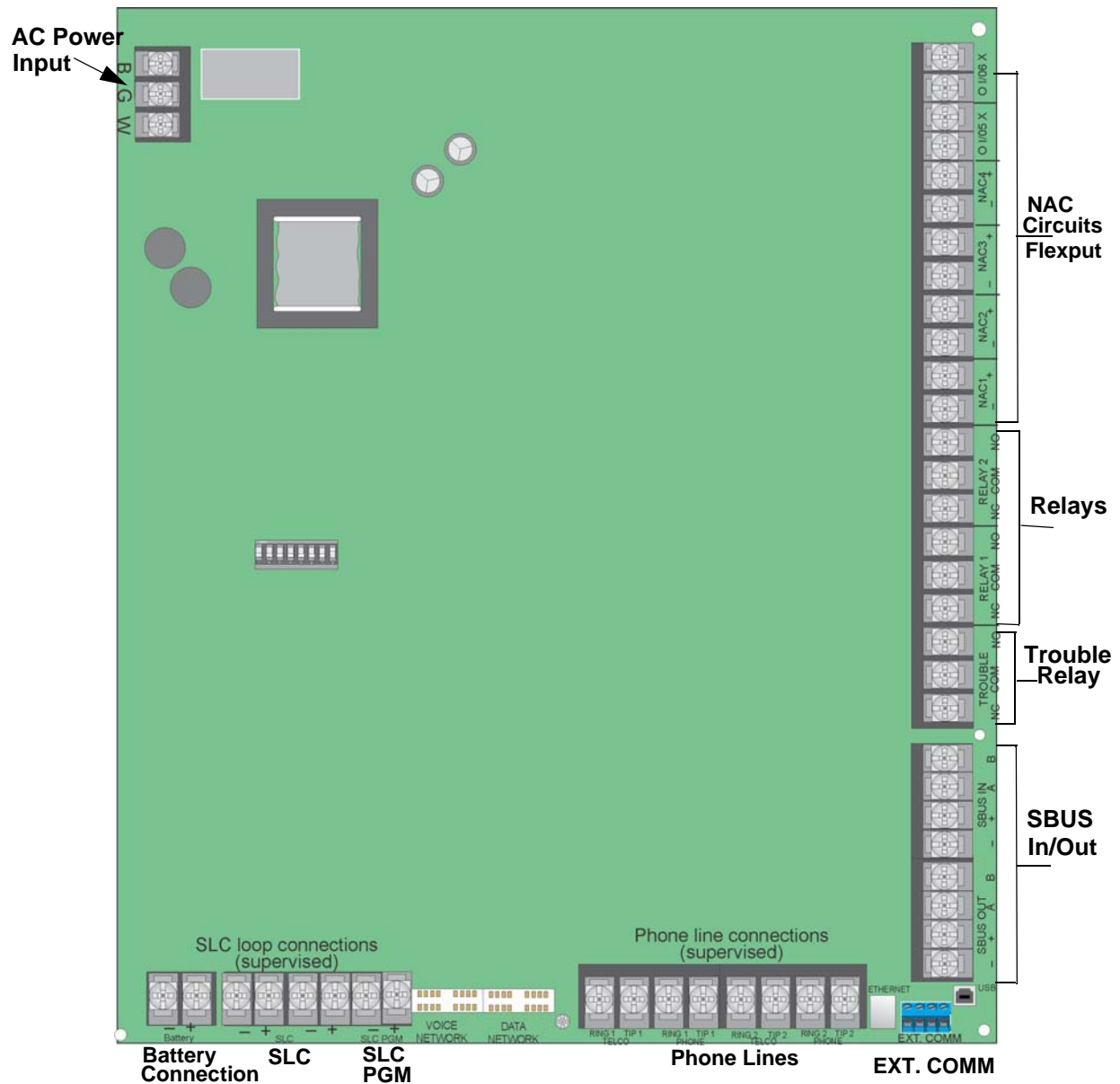

Figure 3-2 Model 6820/EVS Assembly

Figure 3-2 shows the circuit boards and annunciator. If you should need to remove the control board for repair, do so by removing the nuts that hold the heat sink bracket to into the cabinet. Then lift the control board out of the cabinet.

3.7 Calculating Current Draw and Standby Battery

This section is for helping you determine the current draw and standby battery needs if you are using SK addressable devices (Table 3-2) or SD addressable devices (Table 3-3).

3.7.1 Current Draw Worksheet Requirements

The following steps must be taken when determining 6820/6820EVS current draw and standby battery requirements.

1. You will use the Current Draw Worksheet to determine current draw and standby battery requirements. Use Table 3-2 if installing SK SLC Devices and Table 3-3 if installing SD SLC Devices. For the 6820 / 6820EVS, the worst case current draw is listed for the panel, addressable devices, and all SBUS expanders. Fill in the number of addressable devices and expanders that will be used in the system and compute the current draw requirements for alarm and standby. Record this information in the Current Draw Worksheet on Line A.
2. Add up the current draw for all auxiliary devices and record in the table on Line B.
3. Add up the current draw for all notification appliances and record in the table on Line C.
4. For notification appliances and auxiliary devices not mentioned in the manual, refer to the device manual for the current ratings.
5. Make sure that the total alarm current you calculated, including current for the panel itself, does not exceed 6.0 A. This is the maximum alarm current for the 6820 / 6820EVS control panel.

If the current is above 6.0 A you will need to use a notification power expander(s) such as the Honeywell Silent Knight 5495 or the 5895XL intelligent power expander, to distribute the power loads so that the 6820 / 6820EVS or the power expanders do not exceed their power ratings. Refer to the current draw worksheets provided with the 5495 or the 5895XL manuals so you do not exceed their power ratings.

6. Complete the remaining instructions in the appropriate Current Draw Worksheet for determining battery size requirements.

3.7.2 Current Draw Worksheet for SK SLC Devices

Use Table 3-2 to determine current requirements during alarm/battery standby operation SK SLC devices are installed. The 6820EVS FACP supports up to a total of 1110 SLC devices, consisting of any combination of Sensors and Modules.⁶

Table 3-2 Current Draw Worksheet for SK SLC Devices

Device	# of Devices	Current per Device	Standby Current	Alarm Current
For each device use this formula: This column X This column = Current per number of devices.				
Fire Panel (battery current draw)	1	Standby:	190 mA	
		Alarm:	250 mA	250 mA

Table 3-2 Current Draw Worksheet for SK SLC Devices

Device	# of Devices	Current per Device	Standby Current	Alarm Current	
Addressable SLC Detectors					
SK-PHOTO		Standby/Alarm: .30 mA ¹	mA	mA	
SK-PHOTO-T			mA	mA	
SK-HEAT			mA	mA	
SK-HEAT-HT			mA	mA	
SK-ACCLIMATE			mA	mA	
SK-HEAT-ROR			mA	mA	
SK-DUCT ² (includes PhotoR)			mA	mA	
SK-BEAM (without integral test)		SLC	Standby/Alarm: 2 mA		
		Aux. Pwr	Standby: 2 mA	mA	
			Alarm: 8.5 mA		mA
SK-BEAM-T ³ (with integral test)	SLC	Standby/Alarm: 2 mA	mA	mA	
	Aux. Pwr	Standby: 2 mA	mA		
		Alarm: 8.5 mA		mA	
SK-FIRE-CO	SLC	Standby: .30 mA	mA		
		Alarm: 7.2 mA		mA	
Addressable SLC Module					
SK-MONITOR		Standby/Alarm: .375 mA	mA	mA	
SK-MINIMON			mA	mA	
SK-PULL-SA			mA	mA	
SK-PULL-DA			mA	mA	
SK-MONITOR-2		Standby/Alarm: .75 mA	mA	mA	
SK-MONITOR-10		Standby/Alarm: 3.5 mA	mA	mA	
SK-CONTROL		SLC	Standby: .375 mA	mA	
			Alarm: .375 mA		mA
		Aux Pwr	Standby: 1.7 mA	mA	
			Alarm: 7 mA		mA
SK-CONTROL-6	SLC	Standby: 2.25 mA	mA		
		Alarm: 2.25 mA		mA	
	Aux Pwr	Standby: 8 mA	mA		
		Alarm: 20 mA		mA	
SK-RELAY	Standby/Alarm: .255 mA	mA	mA		
SK-RELAY-6	Standby/Alarm: 1.45 mA	mA	mA		
SK-RELAYMON-2	Standby: 1.3 mA	mA			
	Alarm: 24 mA		mA		
SK-ZONE	Aux Pwr	Standby 12 mA	mA		
		Alarm 90 mA		mA	
SK-ZONE-6	SLC	Standby/Alarm .27 mA	mA	mA	
		Aux Pwr	Standby 50 mA	mA	
	SLC	Alarm 270 mA		mA	
		Standby/Alarm 2 mA	mA	mA	

Table 3-2 Current Draw Worksheet for SK SLC Devices

Device	# of Devices	Current per Device		Standby Current	Alarm Current	
SLC Modules						
B200SR Sounder Base		Aux Pwr	Standby:	.5 mA	mA	
			Alarm:	35 mA	mA	
B200S Intelligent Sounder Base		SLC	Standby	.3 mA	mA	
			Aux Pwr	Standby:	.5 mA	mA
				Alarm: (high vol)	35 mA	mA
B200SR-LF Low Frequency Sounder Base		Aux Pwr	Standby:	1 mA	mA	
			Alarm:	125 mA	mA	
B200S-LF Low Frequency Sounder Base		Aux Pwr	Standby	.55 mA	mA	
			Alarm (high vol)	140 mA	mA	
			SLC	Standby	.30 mA	mA
B224RB Relay Base		Standby/Alarm:		0.5 mA	mA	
RTS151/151 KEY		Alarm:		7.5 mA	mA	
RA100Z		Alarm:		10 mA	mA	
SLC Isolator Devices						
SK-ISO (Isolator Module)	(100 max/loop)	Standby/Alarm:		.45 mA	mA	
B224BI Isolator Base		Standby/Alarm:		.5 mA	mA	
Accessories Modules						
6815 SLC Expander	(63 max.)	Standby/Alarm:		78 mA	mA	
6860 Remote LCD Annunciator		Standby:		25 mA	mA	
		Alarm:		50 mA	mA	
5860 Remote LCD Annunciator	(16 max.)	Standby:		20 mA	mA	
		Alarm:		25 mA	mA	
6855 Remote LCD Annunciator		Standby:		20 mA	mA	
		Alarm:		25 mA	mA	
5824 Serial/Parallel I/O Module	(4 max.)	Standby/Alarm:		45 mA	mA	
5895XL Power Supply	(16 max.)	Standby/Alarm:		10 mA	mA	
5496 NAC Expander		Standby/Alarm:		10 mA	mA	
5865-4 LED Annunciator (with reset and silence switches)		Standby:		35 mA	mA	
		Alarm:		145 mA	mA	
5865-3 LED Annunciator	(8 max.)	Standby:		35 mA	mA	
		Alarm:		145 mA	mA	
5880 I/O Module		Standby:		35 mA	mA	
		Alarm:		200 mA	mA	
5883 Relay Interface	(32 max.)	Standby:		0 mA	mA	
		Alarm:		220 mA (22 mA per relay)	mA	
EVS-50W or EVS-125W Audio Amplifier with/without EVS-CE4	(4 max.)	Standby:		10 mA	mA	
		Alarm:		10 mA	mA	
EVS-INT50W Internal Amplifier	(4 max.)	Standby:		52 mA	mA	
		Alarm @ 25V:		275 mA	mA	
		Alarm @ 70V:		310 mA	mA	
EVS-VCM Voice Control Module	(1 max.)	Standby:		70 mA	mA	
		Alarm:		100 mA	mA	

Table 3-2 Current Draw Worksheet for SK SLC Devices

Device	# of Devices	Current per Device		Standby Current	Alarm Current
EVS-SW24 Switch Expander	(5 max.)	Standby:	10 mA	mA	mA
		Alarm:	25 mA		
EVS-RPU Remote Paging Unit	(4 max.)	Standby:	70 mA	mA	mA
		Alarm:	100 mA		
EVS-LOC Local Operating Console (includes 6860, RVM & SW-24)	(4 max.)	Standby:	100 mA	mA	mA
		Alarm:	150 mA		
EVS-100W 100W amplifier	(4 max.)	Standby/Alarm:	10 mA	mA	mA
EVS-100WBU backup daughter card	(4 max.)	Standby/Alarm:	10 mA	mA	mA
Total System Current					
Network Cards					
SK-NIC Network Interface Card	(1 Max.)	Standby/Alarm:	21 mA	mA	mA
SK-FML Fiber Optic Multi Mode	(1 Max.)	Standby/Alarm:	53 mA	mA	mA
SK-FSL Fiber Optic Single Mode	(1 Max.)	Standby/Alarm:	79 mA	mA	mA
Wireless Modules					
WSK-WGI Wireless Gateway		Max current using ext supply	40 mA	mA	mA
		Max current SLC Power	24 mA	mA	mA
Auxiliary Devices ⁴	Refer to devices manual for current rating.				
IPDACT-2 IP Communicator	(1 max.)	Standby:	93 mA	mA	
		Alarm:	136 mA		mA
IPDACT-2UD IP Communicator	(1 max.)	Standby:	98 mA	mA	
		Alarm:	155 mA		mA
CELL-MOD/CELL-CAB-SK		Standby:	55 mA	mA	
		Alarm:	100 mA		mA
		Alarm/Standby:	mA	mA	mA
		Alarm/Standby:	mA	mA	mA
		Alarm/Standby:	mA	mA	mA
		Alarm/Standby:	mA	mA	mA
Auxiliary Devices Current					
Notification Appliance Circuits					
Refer to device manual for current rating.					
5495/5499 Power Supply		24 VDC	One input circuit:	15 mA	mA
			Both input circuits:	30 mA	mA
		Alarm:	mA		mA
		Alarm:	mA		mA
		Alarm:	mA		mA
		Alarm:	mA		mA
Notification Appliances Current					mA
Total current ratings of all devices in system (line A + line B + C)				mA	mA
Total current ratings converted to amperes (line D x .001):				A	A
Number of standby hours:				H	
Multiply lines E and F.				Total standby AH	AH
Alarm sounding period in hours. (For example, 5 minutes = .0833 hours)					H
Multiply lines E and H.				Total alarm AH	AH
Add lines G and I. ⁵				AH	
Multiply by the Derating Factor				x 1.25	
Total ampere hours required					

1. The FACP can only support 5 devices w/LED's on. This current draw has been added to the panels alarm current.
2. The SK-DUCT housing contains a vacant mount for a SK-RELAY (sold separately). Current draw for the SK-RELAY is calculated by increasing the SK-RELAY row of the calculation sheet by one for each SK-RELAY used with a SK-DUCT.
3. SK-BEAM-T draws a maximum of 500mA from Auxiliary power only when the test feature is used. this should be considered when determining auxiliary power capacity but not calculated into current requirements for day to day operation.
4. If using door holders, you do not need to consider door holder current for alarm/battery standby, because power is removed during that time. However, during normal operation, door holders draw current and must be included in the 6.0A total current that can be drawn from the panel.
5. Use next size battery with capacity greater than required.
6. Total does not include isolator devices or accessory bases.

3.7.3 Current Draw Worksheet for SD SLC Devices

Use to determine current requirements during alarm/battery standby operation when SD SLC devices are installed. You can install up to 127 SD devices per loop.⁵

Table 3-3: Current Draw Worksheet for SD SLC Devices

Device	# of Devices	Current per Device		Standby Current	Alarm Current
For each device use this formula: This column X This column = Current per number of devices.					
Fire Panel (Current draw from battery)	1	Standby:	190 mA	190 mA	
		Alarm:	250 mA		250 mA
Addressable SLC Devices					
SD500-AIM				mA	mA
SD500-MIM				mA	mA
SD500-PS				mA	mA
SD500-ARM		Standby/Alarm:	.55 mA ¹	mA	mA
SD505-HEAT				mA	mA
SD505-PHOTO				mA	mA
SD500-ANM		Aux. Pwr	Standby: 8 mA	mA	
			Alarm: 60 mA		mA
SD500-SDM		SLC	Standby/Alarm: .55 mA	mA	mA
		Aux. Pwr	Standby: 20 mA	mA	
			Alarm: 106 mA		mA
SLC Accessory Bases					
SD505-6RB		Standby/Alarm:	.082 mA	mA	mA
SD505-6SB		Aux. Pwr	Standby: 1 mA	mA	
			Alarm: 32 mA		mA
		SLC	Standby/Alarm .082 mA	mA	mA
SD505-DUCTR		Aux. Pwr	Standby: 20 mA ²	mA	
			Alarm: 62 mA ²		mA
		SLC	Standby/Alarm: .5 mA	mA	mA
SD505-DTS-K			None, included with SD505-DUCTR worst case.		
SD505-DUCT			None, included with detector current.		
SLC Isolator Devices					
SD500-LIM	(100 max/loop)	Standby/Alarm		mA	mA
SD505-6IB					
Accessories Modules					
5815XL SLC Loop Expander	(63 max.)	Standby/Alarm:		55 mA	mA
6860 Remote LCD Annunciator.		Standby:		25 mA	mA
		Alarm:		50 mA	mA
5860 Remote LCD Annunciator.	(16 max.)	Standby:		20 mA	mA
		Alarm:		25 mA	mA
6855 Remote LCD Annunciator		Standby:		20 mA	mA
		Alarm:		25 mA	mA
5824 Serial/Parallel Printer Interface	(4 max.)	Standby/Alarm:		45 mA	mA

Table 3-3: Current Draw Worksheet for SD SLC Devices

Device	# of Devices	Current per Device	Standby Current	Alarm Current
5895XL Power Supply	(16 max.)	Standby/Alarm: 10 mA	mA	mA
5496 NAC Expander		Standby/Alarm: 10 mA	mA	mA
5865-4 LED Annunciator Module (with reset and silence switches)	(8 max.)	Standby: 35 mA	mA	
		Alarm: 145 mA		mA
5865-3 LED Annunciator Module		Standby: 35 mA	mA	
		Alarm: 145 mA		mA
5880 LED I/O Module		Standby: 35 mA	mA	
		Alarm: 200 mA		mA
5883 Relay Interface	(32 max.)	Standby: 0 mA	mA	
		Alarm: 220 mA (22 mA per relay)		mA
EVS-50W or EVS-125W Audio Amplifier with/without EVS-CE4	(4 max.)	Standby: 10 mA	mA	
		Alarm: 10 mA		mA
EVS-INT50W Internal Amplifier	(4 max.)	Standby: 52 mA	mA	
		Alarm @ 25V: 275 mA		mA
		Alarm @ 70V: 310 mA		mA
EVS-VCM Voice Control Module	(1 max.)	Standby: 70 mA	mA	
		Alarm: 100 mA		mA
EVS-SW24 Switch Expander	(5 max.)	Standby: 10 mA	mA	
		Alarm: 25 mA		mA
EVS-RPU Remote Paging Unit	(4 max.)	Standby: 70 mA	mA	
		Alarm: 100 mA		mA
EVS-LOC Remote Command Unit (includes 6860, RVM & SW-24)	(4 max.)	Standby: 100 mA	mA	
		Alarm: 150 mA		mA
EVS-100W 100W Amplifier	(4 max.)	Standby/Alarm: 10 mA	mA	mA
EVS-100WBU backup daughter card	(4 max.)	Standby/Alarm: 10 mA	mA	mA
Total System Current				
Network Cards				
SK-NIC Network Interface Card	(1 Max.)	Standby/Alarm: 21 mA	mA	mA
SK-FML Fiber Optic Multi Mode	(1 Max.)	Standby/Alarm: 53 mA	mA	mA
SK-FSL Fiber Optic Single Mode	(1 Max.)	Standby/Alarm: 79 mA	mA	mA
Auxiliary Devices ³	Refer to devices manual for current rating.			
IPDACT-2 IP Communicator	(1 max.)	Standby: 93 mA	mA	
		Alarm: 136 mA		mA
IPDACT-2UD IP Communicator	(1 max.)	Standby: 98 mA	mA	
		Alarm: 155 mA		mA
CELL-MOD/CELL-CAB-SK		Standby: 55 mA	mA	
		Alarm: 100 mA		mA
		Alarm/Standby: mA	mA	mA
		Alarm/Standby: mA	mA	mA
		Alarm/Standby: mA	mA	mA
		Alarm/Standby: mA	mA	mA
Auxiliary Devices Current				
Notification Appliance Circuits				
Refer to device manual for current rating.				
5495/5499 Power Supply		24 VDC	One input circuit: 15 mA	mA
			Both input circuits: 30 mA	mA
		Alarm: mA		mA
		Alarm: mA		mA
		Alarm: mA		mA
		Alarm: mA		mA
Notification Appliances Current				mA
Total current ratings of all devices in system (line A + line B + C)			mA	mA
Total current ratings converted to amperes (line D x .001):			A	A
Number of standby hours:			H	
Total standby AH			AH	

A

B

C

D

E

F

G

Table 3-3: Current Draw Worksheet for SD SLC Devices

Device	# of Devices	Current per Device	Standby Current	Alarm Current
Alarm sounding period in hours. (For example, 5 minutes = .0833 hours)				H
Multiply lines E and H.		Total alarm AH		AH
Add lines G and I. ⁴			AH	
Multiply by the Derating Factor			x 1.25	
Total ampere hours required				

1. The FACP can only support 5 devices w/LED's on. This current draw has been added to the panels alarm current.
2. If using 24 VDC aux power only. No standby or alarm current for battery calculation if using 24 VAC, 120 VAC or 240 VAC.
3. If using door holders, you do not need to consider door holder current for alarm/battery standby, because power is removed during that time. However, during normal operation, door holders draw current and must be included in the 6.0A total current that can be drawn from the panel.
4. Use next size battery with capacity greater than required.
5. Total does not include isolator devices or accessory bases.

3.7.4 Maximum Battery Standby Load

Table 3-4 and Table 3-5 show the standby load calculations for the 6820 / 6820EVS based on 24 and 90 hours of standby. The standby load calculations of line D in the Current Draw Calculation Worksheet must be less than the number shown in Table 3-4 and Table 3-5 for the selected battery size, standby hour and alarm time. The numbers below have a built in 20% derating factor for the battery amp-hour capacity.

Table 3-4: Maximum Battery Standby Loads for 24 Hour Standby

Rechargeable Battery Size	24 hr Standby, 5 mins. Alarm	24 hr Standby, 15 min alarm	24 hr Standby, 20 min alarm
17AH			
18AH			
24AH			
33AH			
35AH			
40AH			
55AH			

Table 3-5: Maximum Battery Standby Loads for 90 Hour Standby*

Rechargeable Battery Size	90 hr Standby, 5 min alarm	90 hr Standby, 15 min alarm	90 hr Standby, 20 min alarm
33 AH	N/A	N/A	N/A
40 AH	347 mA	331 mA	322 mA
55 AH	480 mA	464 mA	456 mA

Warning

Honeywell Silent Knight does not support the use of batteries smaller than those listed in Table 3-4 and Table 3-5. If you use a battery too small for the installation, the system could overload the battery resulting in the installation having less than the required 24 hours standby power. Use Table 3-4 and Table 3-5 to calculate the correct battery amp hour rating needed for your installation. It is recommended that you replace batteries every five years.

*For FM Installation only

Section 4

Control Panel Installation

4.1 Mounting the Control Panel Cabinet

The 6820 cabinet can be surface or flush-mounted. Cabinet base dimensions are 14.5" W x 24.75" H. There should be 1.5" to 1.75" of cabinet extruding from the wall, this should be measured from either the top edge or bottom edge to the exterior side of the sheet rock. Do NOT flush mount in a wall designated as a fire break.

The 6820EVS cabinet can be surface or flush mounted. Cabinet overall dimensions are 21.592" W x 28.12" H. If you flush mount the cabinet, the backbox dimensions are 20"W x 26.5"H x 4.1"D. There should be 1.5" to 1.75" of cabinet extruding from the wall, this should be measured from either the top edge or bottom edge to the exterior side of the sheet rock. Do NOT flush mount in a wall designated as a fire break.

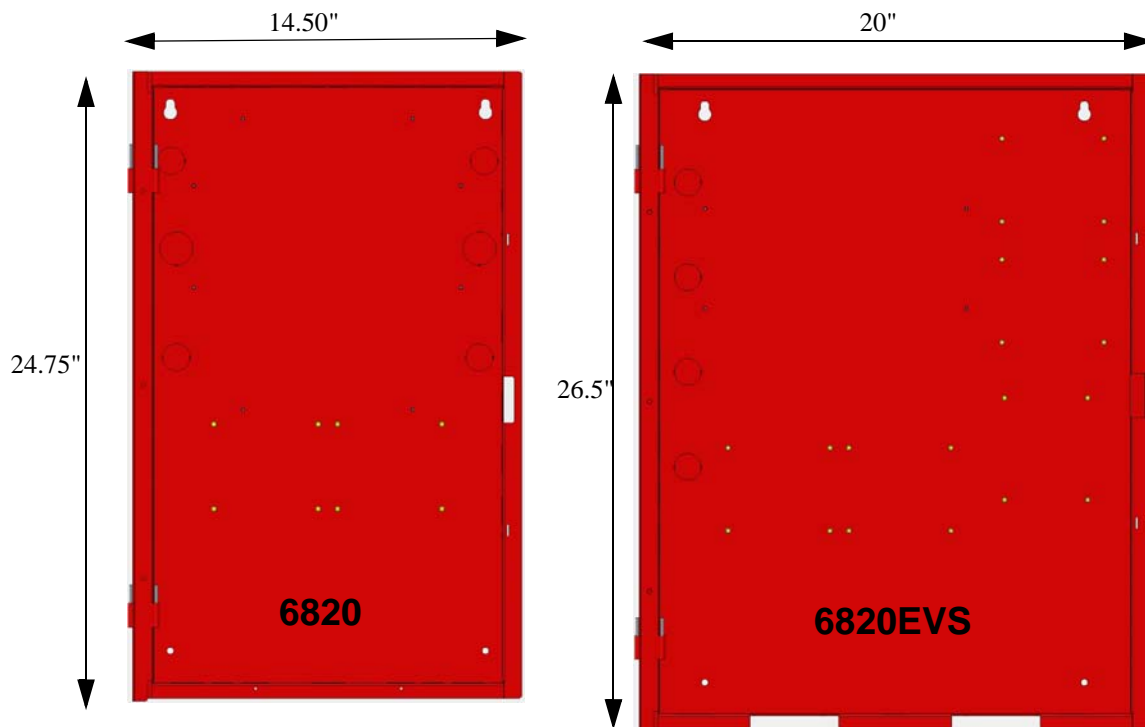

Figure 4-1 FACP Cabinet Base

4.1.1 Preventing Water Damage

Water damage to the fire system can be caused by moisture entering the cabinet through the conduits. Conduits that are installed to enter the top of the cabinet are most likely to cause water problems. Installers should take reasonable precautions to prevent water from entering the cabinet. Water damage is not covered under warranty.

4.1.2 Removing the 6820 / 6820EVS Assembly from the Housing

If it should ever be necessary to remove the control panel assembly from the cabinet for repair, do so by unscrewing the nuts that connect the control panel assembly to the cabinet. Do not attempt to disassemble the circuit boards. See Section 3.7 for location of the nuts.

4.1.3 Ethernet Connection

Ethernet connection is used for IP communication. For port location see Figure 3-2.

4.2 AC Connection

At installation, connect the AC terminals to the power source as shown in Figure 4-2. It may be necessary for a professional electrician to make this connection.

Warning: RISK OF ELECTRICAL SHOCK AND EQUIPMENT DAMAGE

Several different sources of power can be connected to this panel. Disconnect all sources of power before servicing. The panel and associated equipment may be damaged by removing and/or inserting cards, modules or interconnecting cables while this unit is energized.

The AC terminals are rated at 120 VAC, 60 Hz, 2.7A.

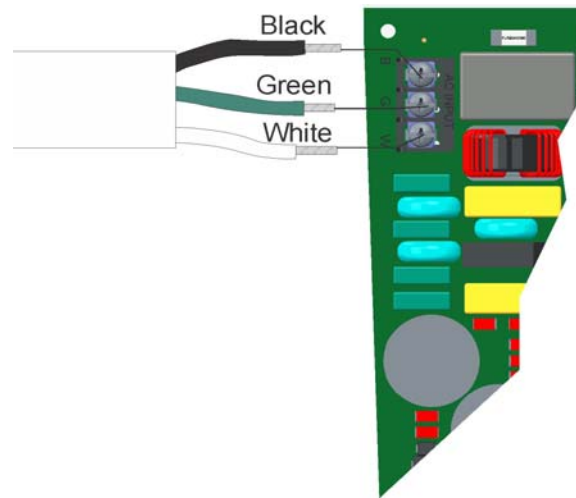

Figure 4-2 120 VAC Power Connection for the 6820 or 6820EVS

4.3 Battery Power

The batteries must be sealed lead acid type. Before connecting the batteries to the FACP, make certain that the interconnect cable between the batteries is not connected. Do not connect the battery jumper cable until the system is completely installed. Observe polarity when connecting the batteries.

WARNING: RISK OF PERSONAL INJURY

Battery contains sulfuric acid which can cause severe burns to the skin and eyes and can destroy fabrics. If contact is made with sulfuric acid, immediately flush the skin or eyes with water for 15 minutes and seek immediate medical attention

The control panel battery charge capacity is 7.0 to 35 AH. Use 12V batteries of the same AH rating. Determine the correct AH rating as per your current load calculation (see Section 3.7).

Wire batteries in series to produce a 24-volt equivalent. Do not parallel batteries to increase the AH rating. It is recommended that you replace batteries every five years.

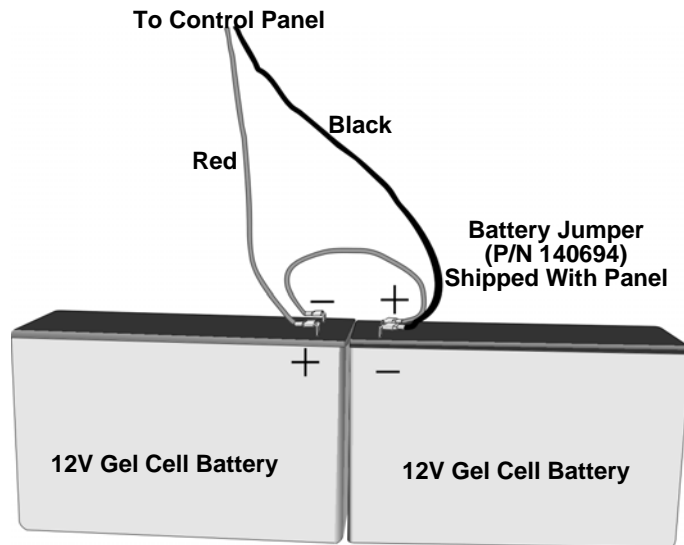

Figure 4-3 Battery Connection

4.3.1 Battery Accessory Cabinet

The Model RBB Accessory cabinet can be used when your backup batteries requirements use backup batteries that are too large to fit into the main control panel cabinet. The RBB cabinet holds batteries up to the 35 AH size. The RBB dimensions are 16" W x 10" H x 6" D (40.64 cm W x 25.4 cm H x 15.24 cm D).

4.3.1.1 Installing the RBB Accessory Cabinet and Batteries

To properly install the accessory cabinet and backup batteries, follow these steps:

1. Mount the accessory cabinet. See Figure 4-4 for the four cabinet mounting holes.
 - If mounting onto drywall the accessory cabinet must be mounted onto 3/4-inch plywood. This is necessary because the weight of the batteries inside the accessory cabinet could cause the cabinet to pull away from the drywall.
 - When mounting on concrete, especially when moisture is expected, attach a piece of 3/4" plywood to the concrete surface and then attach the RBB cabinet to the plywood.

- If using the battery cable extenders provided (P/N 140643), mount the RBB cabinet no more than 18" away from the main control panel cabinet. This will ensure that the battery cables reach the battery terminals.

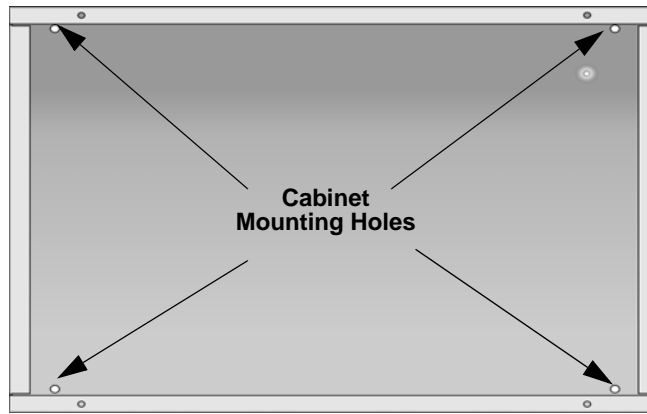

Figure 4-4 RBB Cabinet Mounting Holes

2. Connect the main control panel battery cables to the battery cable extenders as shown in Figure 4-5.

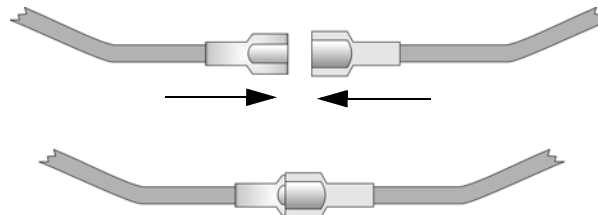

Figure 4-5 Splicing Control panel Battery Cable to RBB Battery Cable Extenders

3. Run extended battery cable from control panel cabinet through conduit to RBB cabinet. See Figure 4-6.

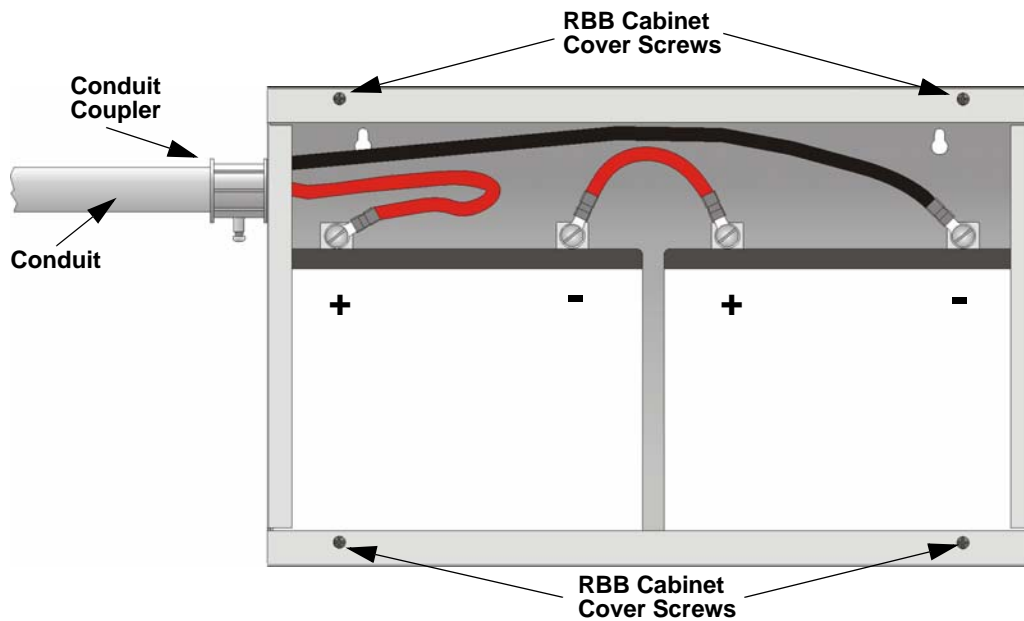

Figure 4-6 Battery Connections in the RBB Cabinet

Note: Figure 4-6 is an example of how the wire connections can be routed. However, any other cabinet knock-

outs (on either the main control panel or the RBB cabinet), that are not previously being used may be utilized to connect conduit between the two cabinets.

4. Connect battery leads to the backup battery terminals. See Figure 4-6.
Observe the proper polarity to prevent damage to the batteries or the control panel.
5. Insert the RBB cover screws into the cover mounting holes. See Figure 4-6.
Screw the cover screw $\frac{3}{4}$ of the way into the cover mounting hole.
6. Align the cover plate mounting keyhole over the cover mounting screws. See Figure 4-7.

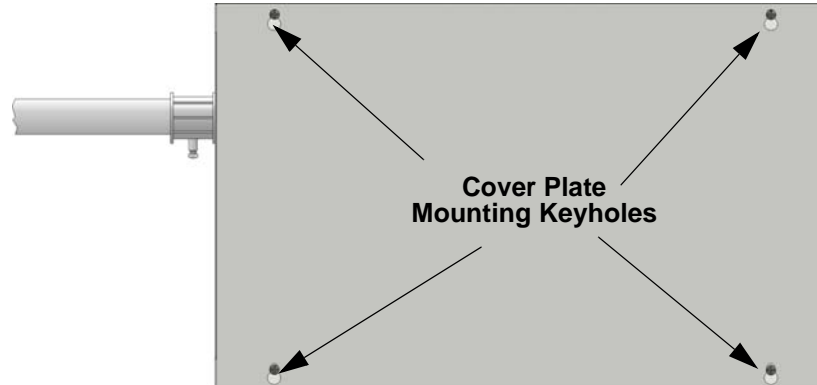

Figure 4-7 Cover Plate Mounting Keyholes and Cover Mounting Screws Alignment

7. Slide the cover into place and tighten the cover mounting screws. See Figure 4-7.

4.4 SBUS Wiring

This section contains information on calculating SBUS wire distances and the types of wiring configurations (Class A and B).

4.4.1 Calculating Wiring Distance for SBUS Modules

The following instructions will guide you in determining the type of wire and the maximum wiring distance that can be used with control panel SBUS accessory modules.

To calculate the wire gauge that must be used to connect SBUS modules to the control panel, it is necessary to calculate the total worst case current draw for all modules on a single 4-conductor bus. The total worst case current draw is calculated by adding the individual worst case currents for each module. The individual worst case values are shown in the table below.

Note: Total worst case current draw on a single SBUS cannot exceed 1 amp. If a large number of accessory modules are required, and the worst case current draw will exceed the 1 amp limit, then the current draw must be distributed using 5895XL Power Expanders. Each 5895XL Power Expander provides an additional SBUS, with an additional 1 amp of SBUS current. Wiring distance calculations are done separately for each 5895XL, and separately for the control panel itself.

Table 4-1: SBUS Device Current Draw

Model Number	Worst Case Current Draw
6860, 5860, 6855 Fire Annunciator	.120 amps
5815XL SLC Loop Expander	.150 amps
6815 SLC Loop Expander	.078 amps
5824 Serial/Parallel Printer Interface Module	.040 amps
5880 LED I/O Module	.250 amps
5865 LED Annunciator	.200 amps

Table 4-1: SBUS Device Current Draw

Model Number	Worst Case Current Draw
5895XL Intelligent Power Supply	.010 amps
5496 Intelligent Power Supply	.010 amps
EVS-50W	.010 amps
EVS-125W	.010 amps
EVS-100W	.010 amps
EVS-100W with EVS-100WBU	.010 amps
EVS-VCM / EVS-VCM with EVS-SW24* **	.080 amps / .105 amps
EVS-LOC / EVS-LOC with EVS-SW24* **	.080 amps / .105 amps
SK-NIC Network Interface Card	.021 amps
CELL-MOD/CELL-CAB-SK	.145 amps
SK-F485C Fiber Converter	.125 amps

Note: Refer to Table 3-2 is using SK Devices and Table 3-3 if using SD SLC devices for maximum number of each type of device that can be used per system

* All devices must use the same SBUS and VBUS.

** When doing wire calculations, use .080 amps per device with .105 amps for the last device.

After calculating the total worst case current draw, Table 4-2 specifies the maximum distance the modules can be located from the panel on a single wire run. The table ensures 6.0 volts of line drop maximum. In general, the wire length is limited by resistance, but for heavier wire gauges, capacitance is the limiting factor.

These cases are marked in the chart with an asterisk (*). Maximum length can never be more than 6,000 feet, regardless of gauge used. The formula used to generate this chart is shown in the note below.

Table 4-2: Wire Distances Per Wire Gauge Using Copper Wire

Wiring Distance: SBUS Modules to Panel				
Total Worst Case Current Draw (amps)	22 Gauge	18 Gauge	16 Gauge	14 Gauge
0.100	1852 ft.	4688 ft.	* 6000 ft.	* 6000 ft.
0.200	926 ft.	2344 ft.	3731 ft.	5906 ft.
0.300	617 ft.	1563 ft.	2488 ft.	3937 ft.
0.400	463 ft.	1172 ft.	1866 ft.	2953 ft.
0.500	370 ft.	938 ft.	1493 ft.	2362 ft.
0.600	309 ft.	781 ft.	1244 ft.	1969 ft.
0.700	265 ft.	670 ft.	1066 ft.	1687 ft.
0.800	231 ft.	586 ft.	933 ft.	1476 ft.
0.900	206 ft.	521 ft.	829 ft.	1312 ft.
1.000 (Max)	185 ft.	469 ft.	746 ft.	1181 ft.

Note: The following formulas were used to generate the wire distance chart:

$$\text{Maximum Resistance (Ohms)} = \frac{6.0 \text{ Volts}}{\text{Total Worst Case Current Draw (amps)}}$$

$$\text{Maximum Wire Length (Feet)} = \frac{\text{Maximum Resistance (Ohms)}}{\text{Rpu}} \quad * 500$$

(6000 feet maximum)

where: Rpu = Ohms per 1000 feet for various wire gauges (see table below)

Table 4-3: Typical Wire Resistance Per 1000 ft. Using Copper Wire

Wire Gauge	Ohms per 1000 feet (Rpu)
22	16.2
18	6.4
16	4.02
14	2.54

Wiring Distance calculation example:

Suppose a system is configured with the following SBUS modules:

- 2 - Module 5860 Fire Annunciator
- 1 - 5895XL Intelligent Power Expander
- 1 - 5865 LED Annunciator
- 1 - 5824 Serial/Parallel Interface Module

The total worst case current is calculated as follows:

5860 Current Draw	= 2 x .100 amps	= .200 amps
5895XL Current Draw	= 1 x .010 amps	= .010 amps
5865 Current Draw	= 1 x .200 amps	= .200 amps
5824 Current Draw	= 1 x .040 amps	= .040 amps
Total Worst Case Current Draw		= .450 amps

Note: For assistance with SBUS calculation, please refer to www.silentknight.com.

Using this value, and referring to the Wiring Distance table, it can be found that the available options are:

- 370 feet maximum using 22 Gauge wire
- 938 feet maximum using 18 Gauge wire
- 1493 feet maximum using 16 Gauge wire
- 2362 feet maximum using 14 Gauge wire

4.4.2 Wiring Configurations

Figure 4-8 illustrates Class A wiring configuration and Figure 4-9 illustrates Class B configuration.

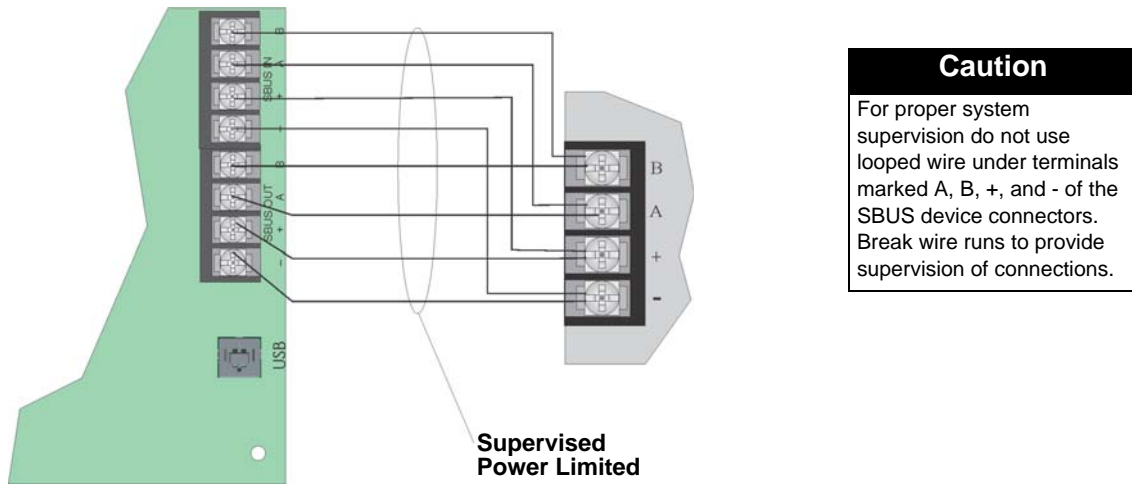

Figure 4-8 SBUS Class A Wiring

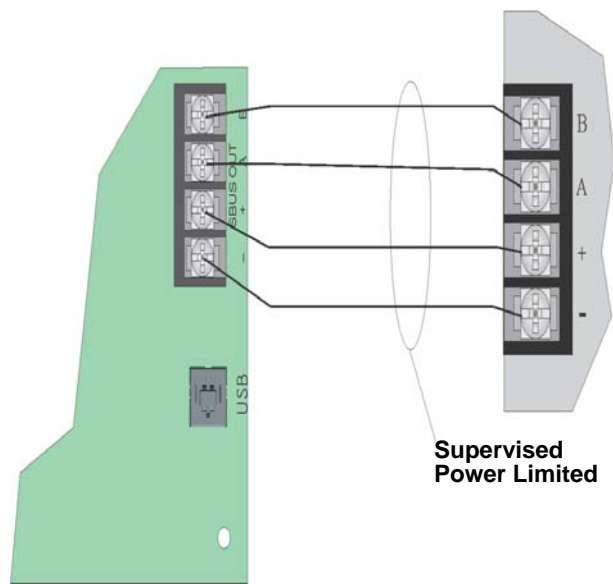

Figure 4-9 SBUS Class B Wiring

4.5 5860 Remote Annunciator Installation

The optional Model 5860 Remote Annunciator, is shown in Figure 4-10. Up to 16 annunciators can be added to the 6820 / 6820EVS system in any combination.

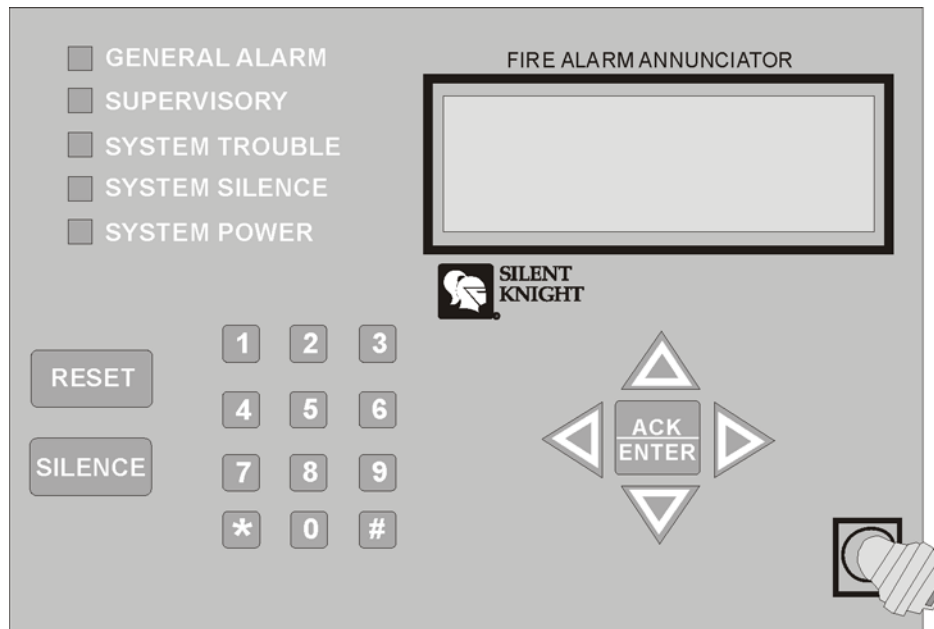

Figure 4-10 Model 5860 Remote Annunciator, Front View

5860 installation involves the following steps:

1. Make sure power is off at the panel.
2. Mount the 5860 in the desired location (see Section 4.5.1).
3. Connect the 5860 to the panel (see Section 4.5.2).
4. Use the DIP switches on the back of the 5860 to assign an ID# to the 5860 (see Section 4.13.1).
5. The new 5860 module must be added to the system through programming. JumpStart will add the module automatically (see Section 8.1). You can also add it manually (see Section 9.2.2). Select a name, if desired (see Section 9.2.1.2).

4.5.1 Mounting the 5860

This section of the manual describes mounting the remote annunciator. The annunciator can be flush- or surface-mounted. Figure 4-11 shows the parts of the annunciator. Instructions for disassembling and mounting appear on

the following pages.

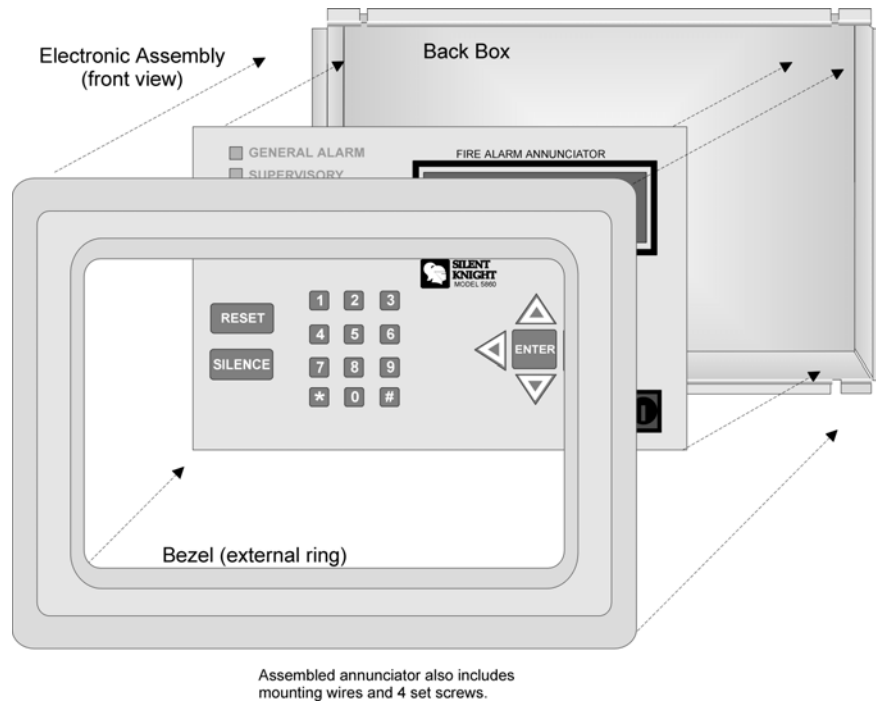

Figure 4-11 Annunciator Parts

The 5860 comes from the factory fully assembled. You must disassemble it for mounting. To disassemble the annunciator, use a 5/64 hex wrench to remove the set screws, located on the bottom of the annunciator bezel. (See Figure 4-12 for location of the set screws).

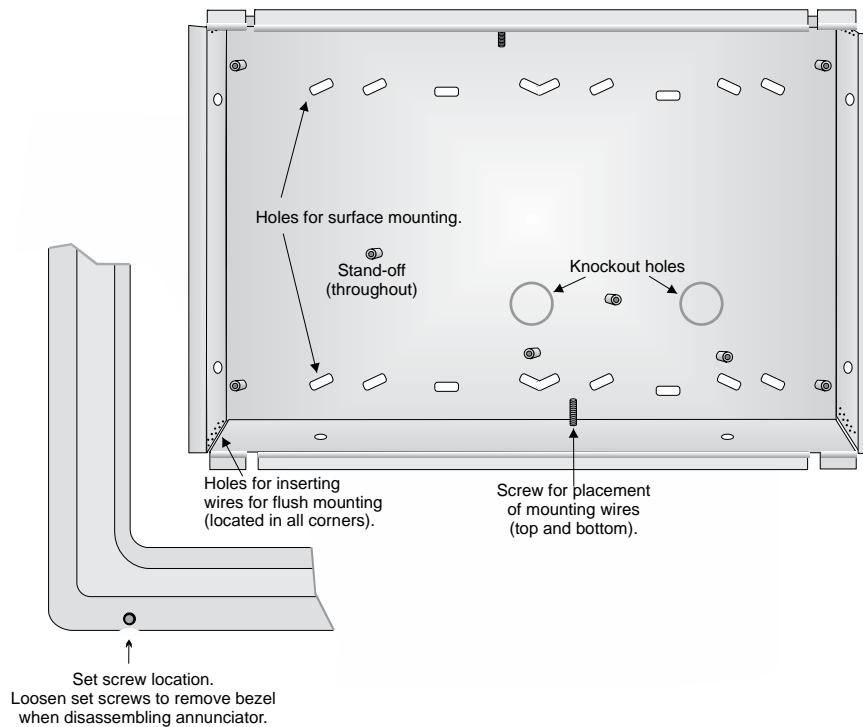

Figure 4-12 Annunciator Back Box and Bezel Details

4.5.1.1 Flush Mounting

This section of the manual describes flush mounting. You can flush-mount with or without an electrical box.

Flush Mounting with an Electrical Box

The 5860 annunciator can be used with the following types of electrical boxes: 4S, single-gang, and double-gang. If an electrical box is used, the box must be 1-3/8" back from the face of the wall to accommodate the annunciator. Studs used with an electrical box must be two by fours (or larger).

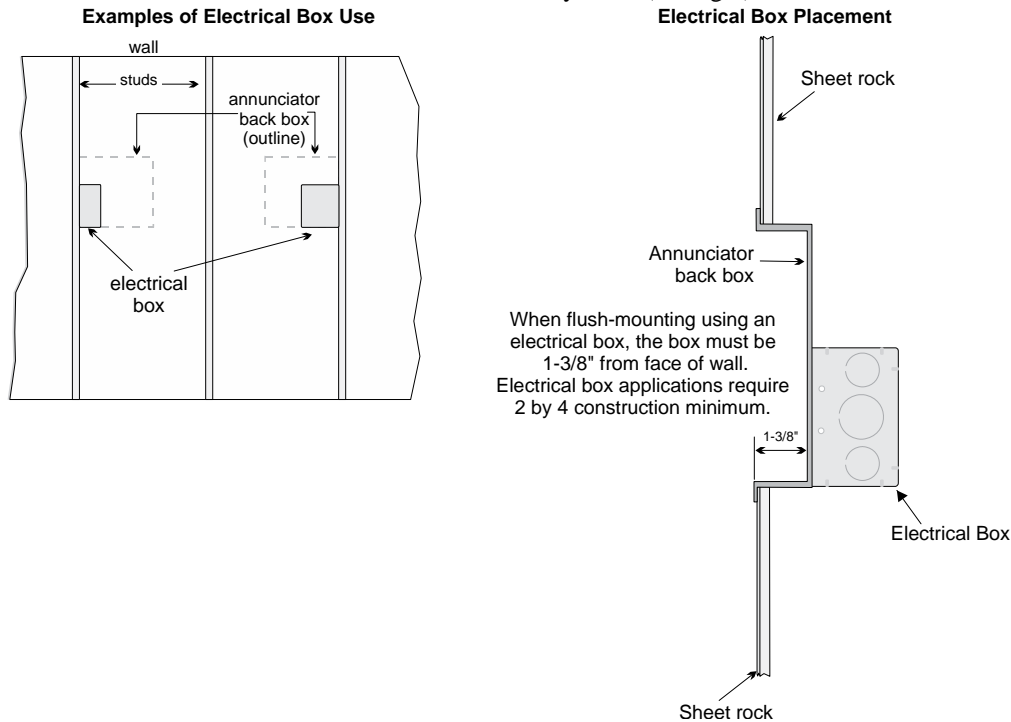

Figure 4-13 Placement of Electrical Box for Flush Mounting

Flush Mounting Steps

1. Cut a hole in the sheet rock to the following dimensions: 8-1/4" W x 6-5/8" H. If an electrical box is used, the box must be 1-3/8" back from face of wall to accommodate the annunciator (see Figure 4-13).
2. Remove knockout holes as needed for wires.
3. Fit the annunciator back box into the hole and stabilize with mounting wires. Angle the mounting wires into the first hole past the sheet rock. Secure the wires behind the screws as shown in Figure 4-14. When all four wires are in place, the back box should fit snugly into the hole in the sheet rock.

4. After the annunciator wiring to the panel has been completed (described in Section 4.5.2), replace the electronic assembly in the back box. Place the bezel over the back box and tighten the set screws on the bezel.

Attach second set of wires to top of back box.

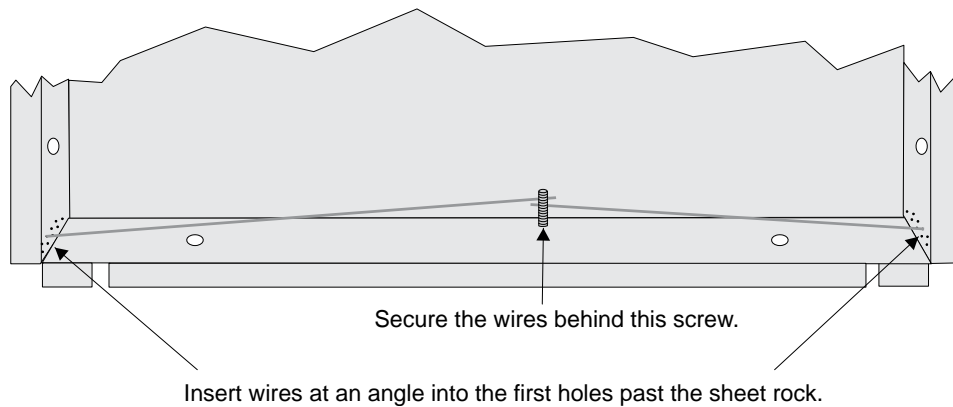

Figure 4-14 Flush Mounting the Back Box

4.5.1.2 Surface Mounting

The 5860 can be mounted directly to a surface or can be attached to a single, double, or four-square electrical box. The Model 5860TG/TR trim ring kit is available for use when surface mounting.

1. Drill holes in the surface to match the screw holes on the back box.
2. Fit the trim ring over the back box.
3. Attach the back box to the surface using screws provided.
4. After the annunciator wiring to the panel has been completed (described in Section 4.5.2), replace the electronic assembly in the back box. Place the bezel over the back box and tighten the set screws on the bezel.

4.5.2 Model 5860 Connection to the Panel

Connect the 5860 to the panel as shown in Figure 4-15.

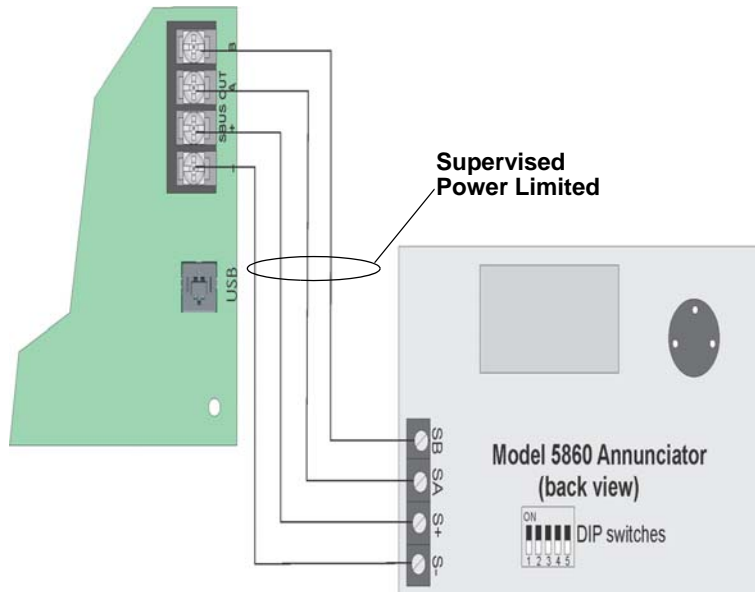

Figure 4-15 Model 5860 Connection to the Panel

4.6 6855 Remote Annunciator Installation

The optional Model 6855 Remote Annunciator, is shown in Figure 4-16. The 6855 can be surface or flush mounted. Up to 16 annunciators can be added to the 6820 or 6820EVS system in any combination.



Figure 4-16 Model 6855 Remote Annunciator, Front View

6855 installation involves the following steps:

1. Make sure power is off at the panel.
2. Mount the 6855 in the desired location (see Section 4.6.1).
3. Connect the 6855 to the panel (see Section 4.4.2).
4. Use the DIP switches on the back of the 6855 to assign an ID# to the 6855 (see Section 4.13.1).
5. The new 6855 module must be added to the system through programming. JumpStart will add the module automatically (see Section 8.1). You can also add it manually (see Section 9.2.2). Select a name, if desired (see Section 9.2.1.1).

4.6.1 Mounting the 6855

This section of the manual describes mounting the remote annunciator. The annunciator can be flush- or surface-mounted.

4.6.1.1 Flush Mounting

This section of the manual describes flush mounting.

Follow these steps to flush mount the 6855

1. The back box dimensions are 9-9/32" W x 8-3/8" H. The minimum depth 2". The back box can be mounted prior to the complete installation of the 6855 using any of the mounting holes shown in Figure 4-17.

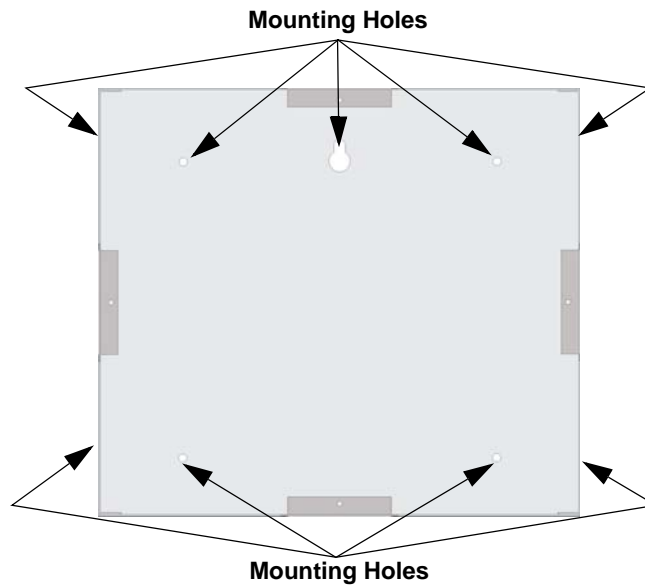

Figure 4-17 Back Box Mounting Holes

2. Remove knockout holes as needed for wires. See Figure 4-18 for backbox knockout locations

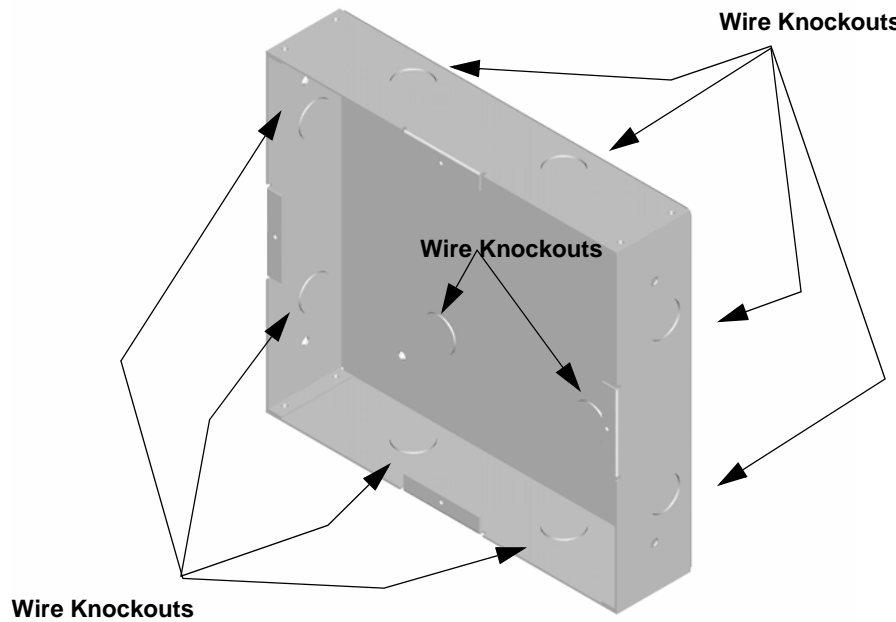

Figure 4-18 Back Box Knockout Locations

3. Wire the Annunciator board to the main control panel. See Figure 4-9.

- Attach the annunciator and door assembly to back box as shown in Figure 4-19 using the supplied screws.

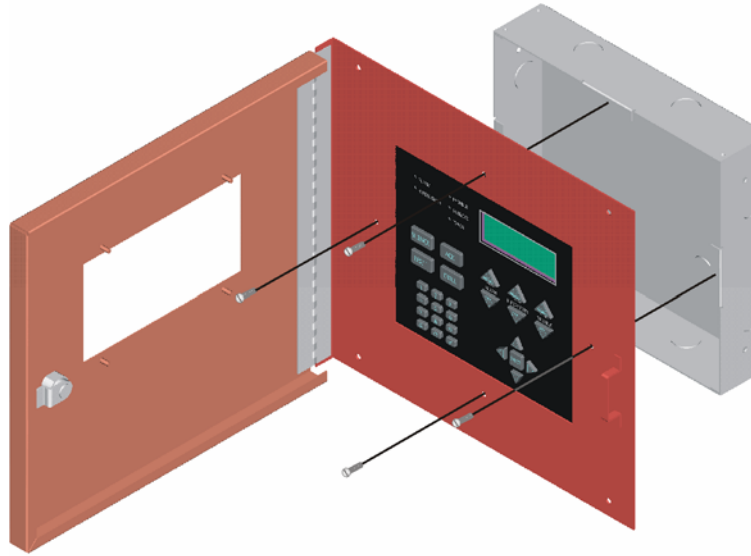

Figure 4-19 Attaching Annunciator/Door Assembly to Backbox

4.6.1.2 Surface Mounting

The optional Model RA-100TG/TR trim ring kit is available for use when surface mounting.

- Remove the desired knock out.
- To properly mount the back box, insert a single screw into the key shaped mounting hole. Do not tighten all the way. See Figure 4-20.

Place a level on top of the back box, with the back box level insert the rest of the mounting screws.

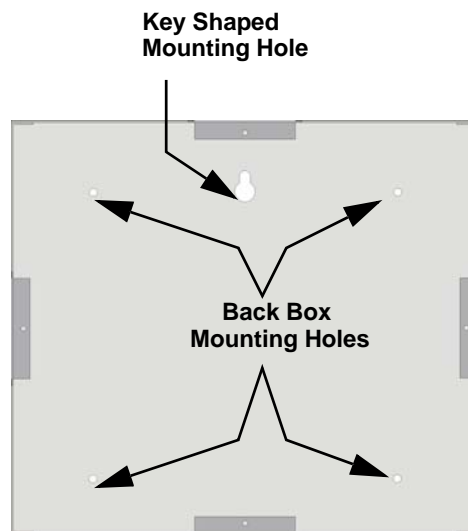

Figure 4-20 Back Box Surface Mount Holes

- Run wires to the control panel.

4.6.2 Model 6855 Connection to the Panel

Connect the 6855 to the panel as shown in Figure 4-21.

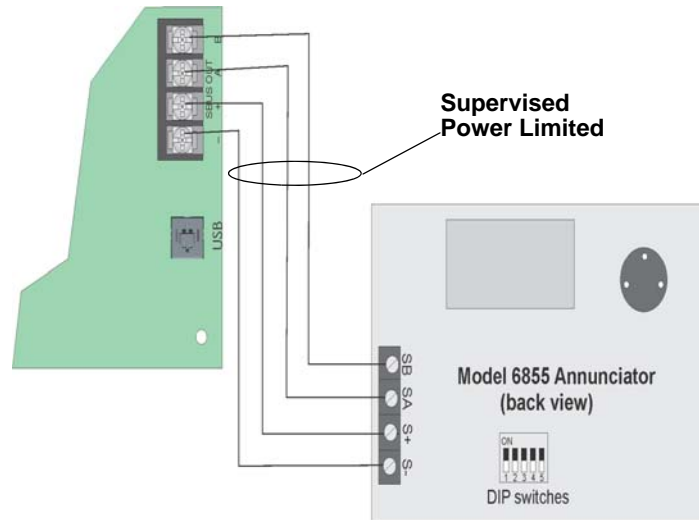

Figure 4-21 Model 6855 Connection to the Panel

4.7 6860 Remote Annunciator Installation

The optional Model 6860 Remote Annunciator, is shown in Figure 4-22. The 6860 can be surface or flush mounted.

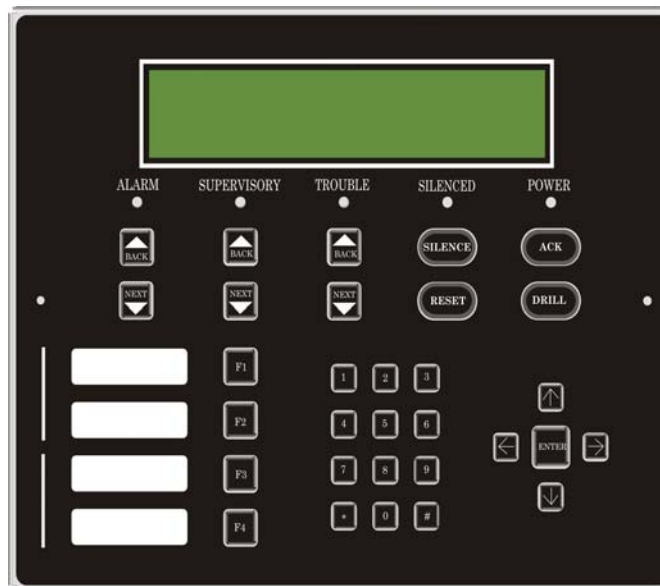

Figure 4-22 6860 Remote Annunciator, Front View

6860 installation involves the following steps:

1. Make sure power is off at the panel.
2. Mount the 6860 in the desired location (see Section 4.7.1).
3. Connect the 6860 to the panel (see Section 4.7.2).

4. Use the DIP switches on the back of the 6860 to assign an SBUS ID# to the 6860 (see Section 4.13.1).
5. The 6860 module must be added to the system through programming. JumpStart AutoProgramming will add the module automatically (see Section 8.1).

4.7.1 Mounting the 6860

This section of the manual describes mounting the remote annunciator. The annunciator can be flush or surface mounted.

4.7.1.1 Flush Mounting

This section of the manual describes flush mounting. Follow these steps to flush mount the 6860

1. The back box dimensions are 9¼" W x 8 3/8" H. The minimum depth required is 2". The back box can be mounted prior to the complete installation of the 6860 using any of the mounting holes shown in Figure 4-23.

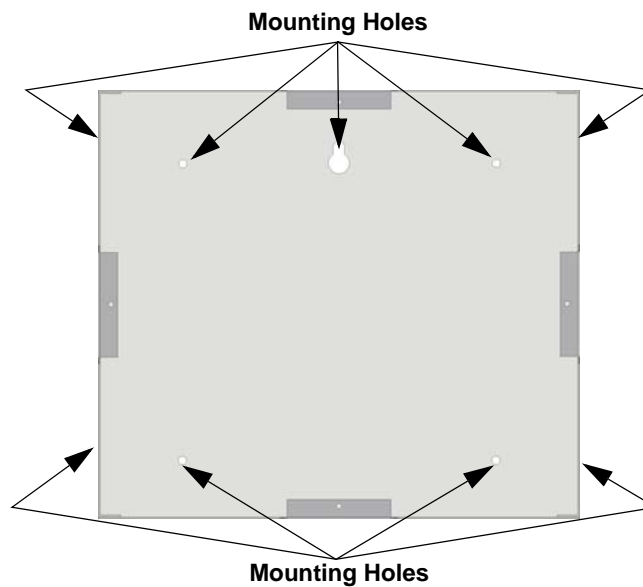

Figure 4-23 Back Box Mounting Holes

2. Remove knockout holes as needed for wires. See Figure 4-24 for backbox knockout locations.

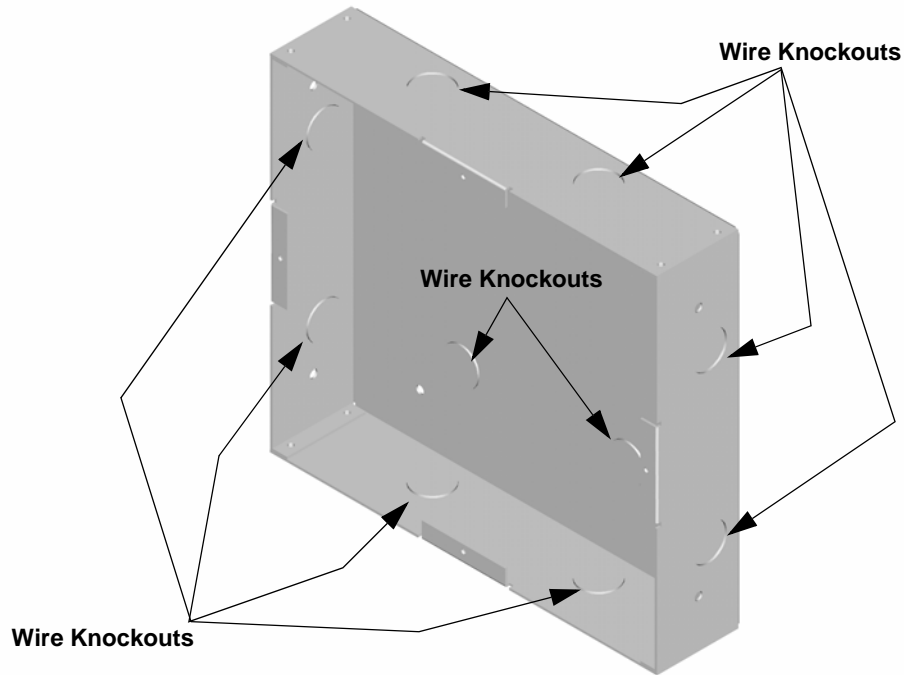

Figure 4-24 Back Box Knockout Locations

3. Wire the annunciator board to the main control panel. As described in Section 4.7.2.
4. Attach the annunciator and door assembly to back box as shown in Figure 4-25 using the supplied screws.

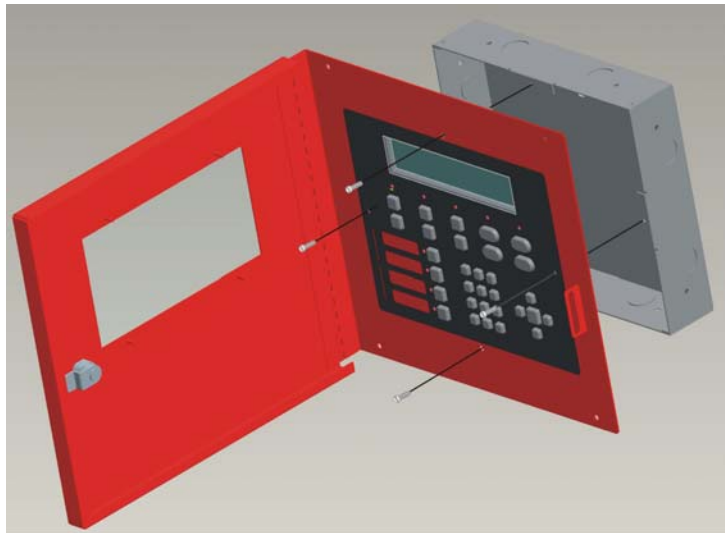

Figure 4-25 Attaching Annunciator / Door Assembly to Backbox

4.7.1.2 Surface Mounting

The Model RA-100TR red trim ring kit is available for use when surface mounting the 6860.

1. Remove the desired knock out.

2. To properly mount the back box, insert a single screw into the key shaped mounting hole. Do not tighten all the way. See Figure 4-26.

Place a level on top of the back box, with the back box level insert the rest of the mounting screws.

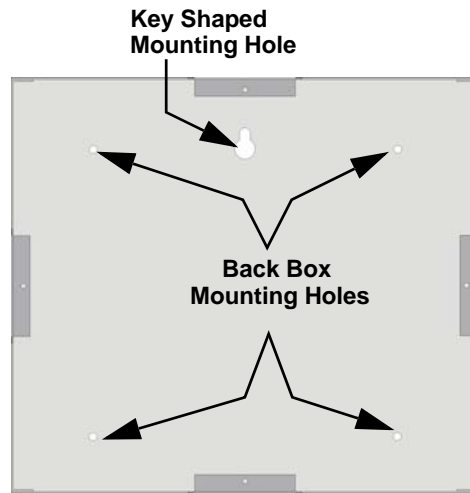

Figure 4-26 Back Box Surface Mount Holes

3. Run wires to the control panel.
4. Place the trim ring over the back box as shown in Figure 4-27.

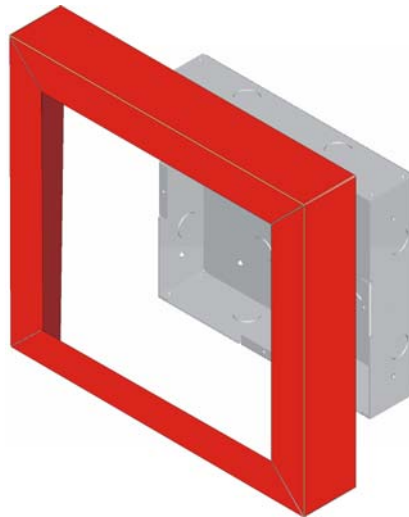

Figure 4-27 Installing Trim Ring

5. Attach the door assembly to the back box using screws provided.
6. After the SBUS wiring to the annunciator is complete (described in Section 4.7.2), replace the electronic assembly in the back box. Place the bezel over the back box and tighten the set screws on the bezel.

4.7.2 6860 Connection to the Panel

Connect the 6860 to the panel as shown in Figure 4-28.

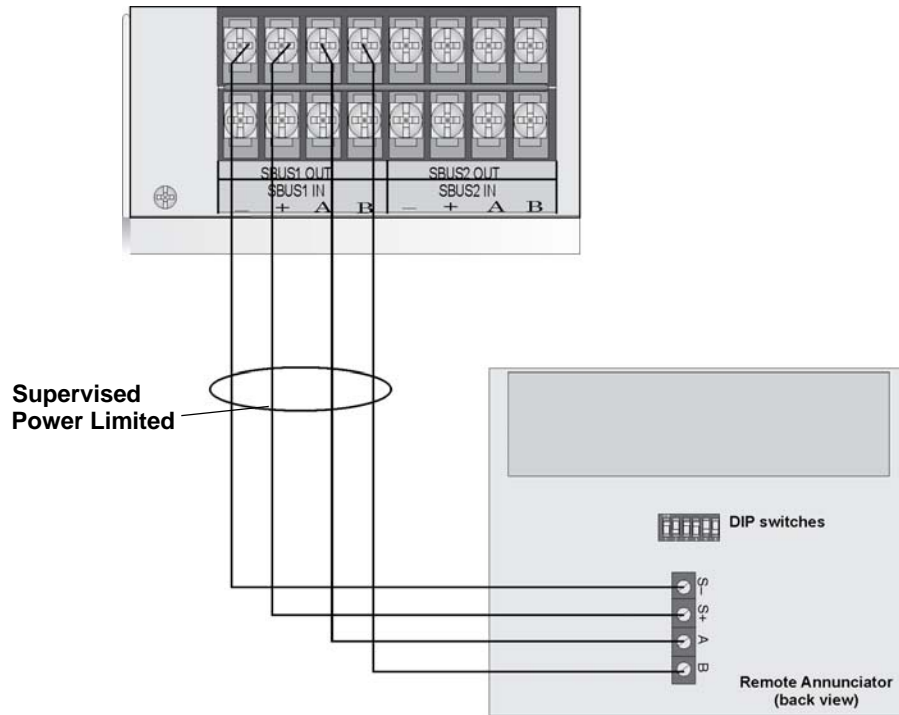

Figure 4-28 Model 6860 Connection to the Panel

4.8 5815XL Installation

The 5815XL SLC expander lets you add 127 SD addressable devices. The maximum number of SLC SD devices per panel is 635. The number of 5815XL's is limited by the maximum number of SBUS devices.

Note: 5815XL will only support SD SLC devices.

To install the 5815XL:

1. Make sure power is off at the panel.
2. Mount the 5815XL in the 6820 cabinet, the 5895XL cabinet, or the 5815RMK remote mounting kit. Use the standoffs located under the control panel board assembly and secure with screws provided with the 5815XL. For additional information, also see *Model 5895XL Installation Instructions* (P/N 151142) or *5815RMK Remote Mounting Kit Installation Instructions* (P/N 151391).
3. Connect the 5815XL to the control panel. (See Section 4.8.1.)
4. Use on-board DIP switches to select an SBUS ID#. (See Section 4.13.1).
5. The new 5815XL module must be added to the system through programming. JumpStart will add the module automatically (see Section 8.1). You can also add it manually (see Section 9.2.2). Select a name, if desired (see Section 9.3.1.1).
6. You are now ready to connect SLC devices to the 5815XL (see Section 9.5.1).

Figure 4-29 is a drawing of the 5815XL board, showing the location of terminals and DIP switches.

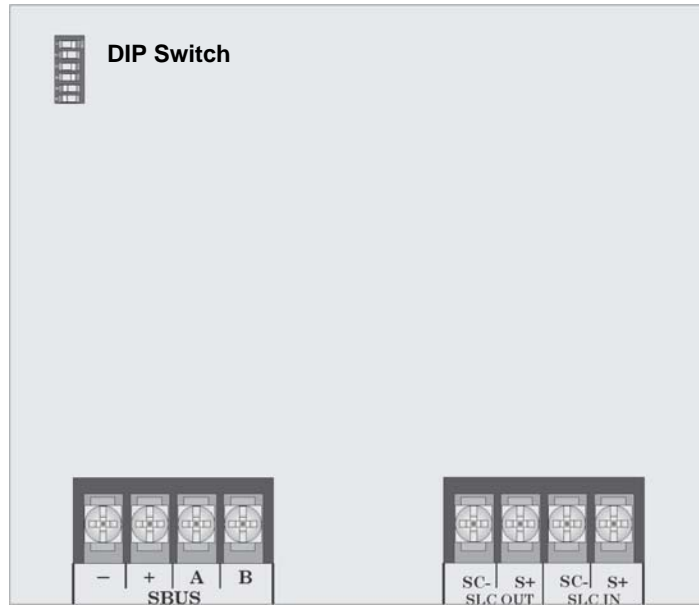

Figure 4-29 5815XL Board

4.8.1 5815XL Connection to the Panel

Connect the 5815XL to the control panel as shown in Figure 4-30. After the 5815XL is connected to the panel, it must be added to the system. This programming step is described in Section 4.13.

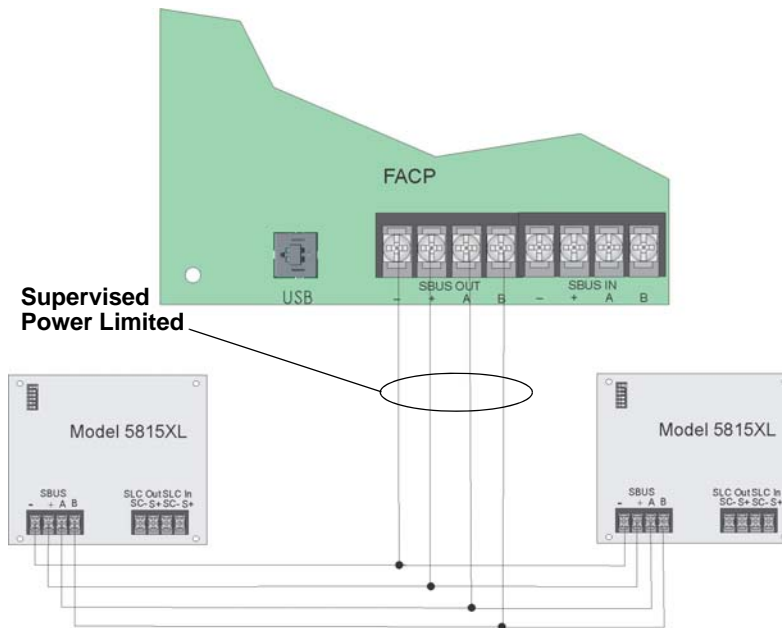

Figure 4-30 5815XL Connection to Main Panel Assembly

4.9 6815 Installation

The 6815 SLC expander lets you add 159 SK detectors and 159 SK modules. The maximum number of SLC devices per panel is 1110. The number of 6815's is limited by the maximum number of SBUS devices.

Note: 6815 will only support SK or SWIFT™ SLC devices.

To install the 6815:

1. Make sure power is off at the panel.
2. Mount the 6815 in the 6820 cabinet, the 5895XL cabinet, or the 5815RMK remote mounting kit. Use the standoffs located under the control panel board assembly and secure with screws provided with the 6815. For additional information, also see *Model 5895XL Installation Instructions* (P/N 151142) or *5815RMK Remote Mounting Kit Installation Instructions* (P/N 151391).
3. Connect the 6815 to the control panel. (See Section 4.8.1.)
4. Use on-board DIP switches to select an SBUS ID#. (See Section 4.13.1).
5. The new 6815 module must be added to the system through programming. JumpStart will add the module automatically (see Section 8.1). You can also add it manually (see Section 9.2.2). Select a name, if desired (see Section 9.3.1.1).
6. You are now ready to connect SLC devices to the 6815 (see Section 9.5.1).

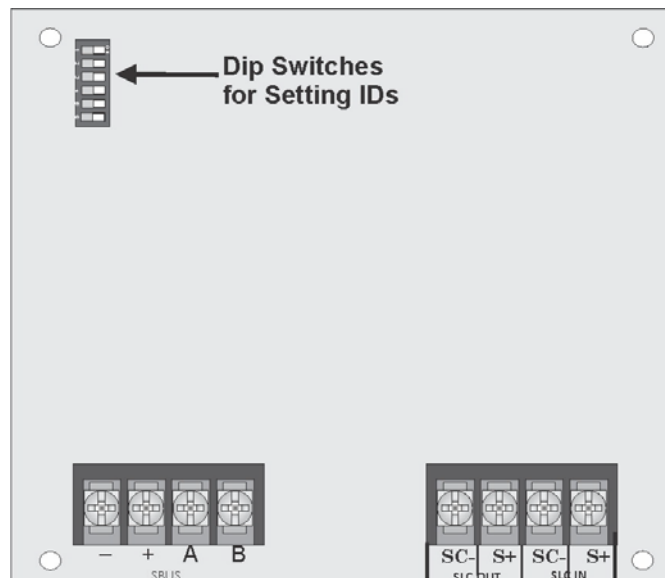

Figure 4-31 6815 Board

Figure 4-31 is a drawing of the 6815 board, showing the location of terminals and DIP switches

4.9.1 6815 Connection to the Panel

Connect the 6815 to the control panel as shown in Figure 4-32. After the 6815 is connected to the panel, it must

be added to the system. This programming step is described in Section 4.13.

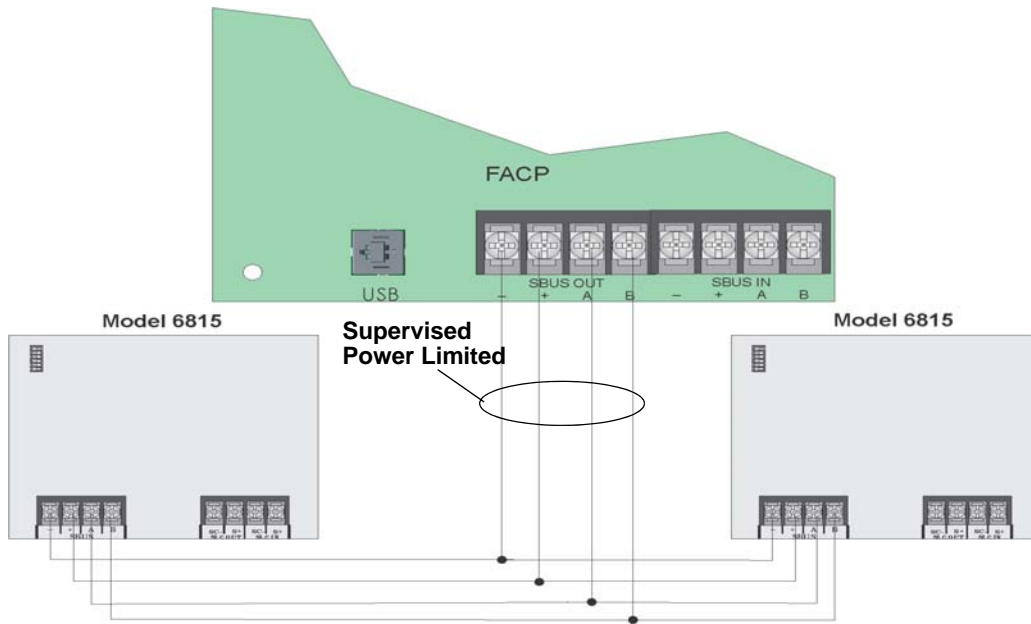

Figure 4-32 6815 Connection to Main Panel Assembly

4.10 5824 Serial/Parallel Interface Module Installation

The 5824 serial/parallel interface module allows you to connect a printer to the panel, so you can print a real-time log of system events, detector status and event history. Instructions for installing the 5824 appear below.

The 5824 and the printer connected to the 5824 Parallel port is ancillary, the serial port can be used for primary fire signaling. The printer must be a UL 864 listed printer.

5824 installation involves the following steps:

1. Make sure power is off at the panel.
2. Connect the 5824 to the panel as shown in Figure 4-33.

Note: Four 5824s per panel maximum.

3. Use the DIP switches on the back of the 5824 board to assign an ID# to the 5824 (see Section 4.13.1).
4. Configure the 5824 device through programming. See Section 4.10.1.
5. Connect a printer to the 5824 as shown in Figure 4-33.

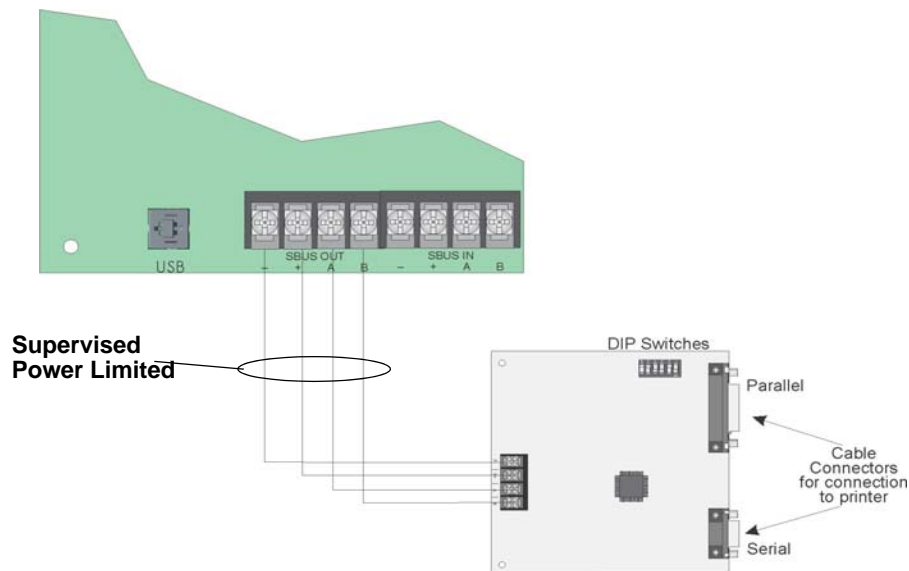

Figure 4-33 5824 Connection to the Panel

4.10.1 Selecting 5824 Options

Configuring the 5824 includes the following steps:

- Add the module to the system. JumpStart® will add the module automatically (see Section 8.1). You can also add it manually (see Section 9.2.2).
- Select a name, if desired (see Section 9.2.1.2).
- Select options for the printer and the output port. See below.

Printer and Output Port Options

1. From the Installer Main Menu, select 7 for Program Menu.
2. Select 1 for Module.
3. Select 1 for Edit Module.
4. From the list that displays, select the 5824 module you want to configure.

- Press the right arrow to skip over the Enter Module ID and Enter Module name options. A screen similar to the one shown in Figure 4-34 will display.

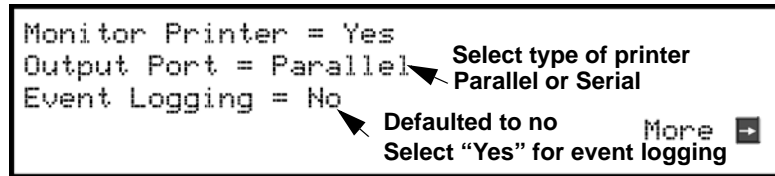

Figure 4-34 Selecting Printer and Output Port Options

- Select options for the printer as needed for your installation. Most printers are parallel.
- If you are using a serial printer, use the next screen to select serial port options as required for your printer. Refer to your printer manual if you need more information.

Option	Choices
Baud Rate:	75 - 19200
Data Bits:	5 - 8
Stop Bits:	.5, 1, 2
Parity:	None, Even, Odd

4.11 5880 LED I/O Module

The 5880 is an LED driver board that can be used in a wide variety of applications, including as an interface with most customized floor plan annunciator boards. The 5880 can drive up to 40 LEDs and has one PZT controller. The 5880 also has eight inputs for monitoring dry contacts. When used with the 6820EVS the 5880 inputs can be programmed to replicate the eight EVS buttons located on the front of the voice control module. (See section 9.5 for programming options). Up to 8 5880s can be added to the 6820/EVS system.

The following sub-sections describe hardware installation. Refer to Section 9 for programming information.

4.11.1 5880 Board Layout

Figure 4-35 shows the locations of screw terminals for connection to the panel and contact monitor wiring; pin

connectors for connecting LEDs; and the DIP switch for selecting an SBUS ID number for the 5880.

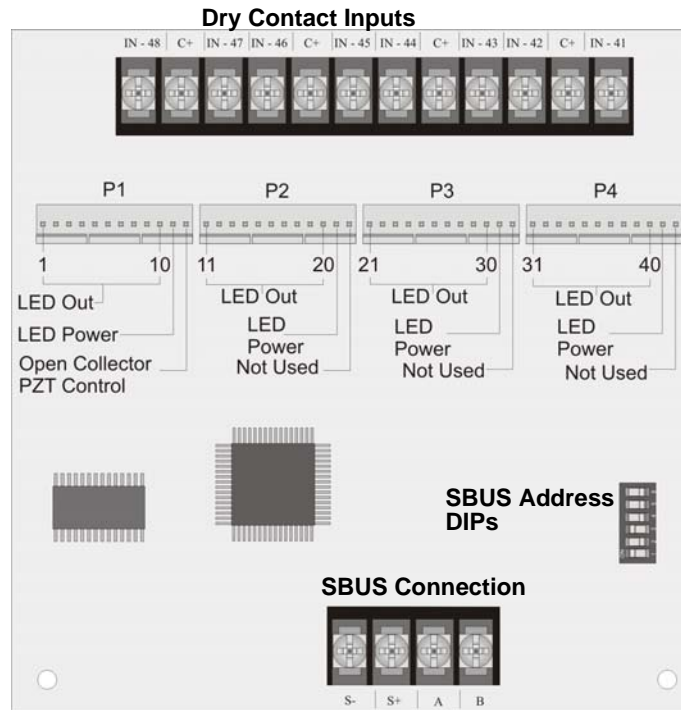

Figure 4-35 5880 Board Layout

4.11.2 5880 Connection to Panel

The 5880 connects to the panel via the SBUS. Make connections as shown in Figure 4-36. After the 5880 is connected to the panel, it must be added to the system. This programming step is described in Section 4.13.

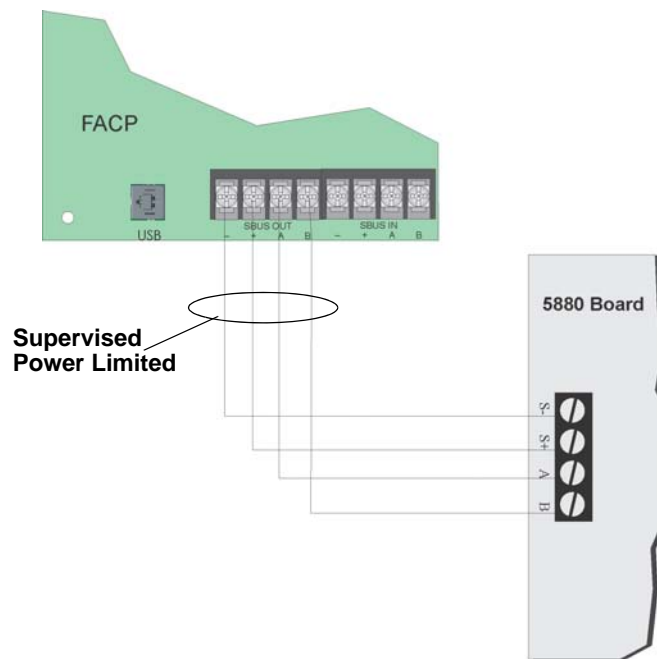

Figure 4-36 5880 Connection to Main Control Panel Assembly

4.11.3 LED Wiring

There are four 12-pin connectors on the 5880 board for connecting LEDs. Each LED gets its power from Pin 11. Internal resistors are sized so that there is approximately 10 mA of current for each LED, no series resistors are required. LED outputs can be mapped to output circuits. See Section 6 for programming details.

Wire the LEDs as shown in Figure 4-37.

On connector P1, Pin 12 is an open collector output for controlling a PZT. If used, the 5880 PZT will match the PZT pattern of the on-board (or 5860) annunciator.

Note: The circuit connected to “Open Collector Output” (last pin on P1) must be current limited so that no more than 100 mA of current is allowed to flow into the open collector transistor.

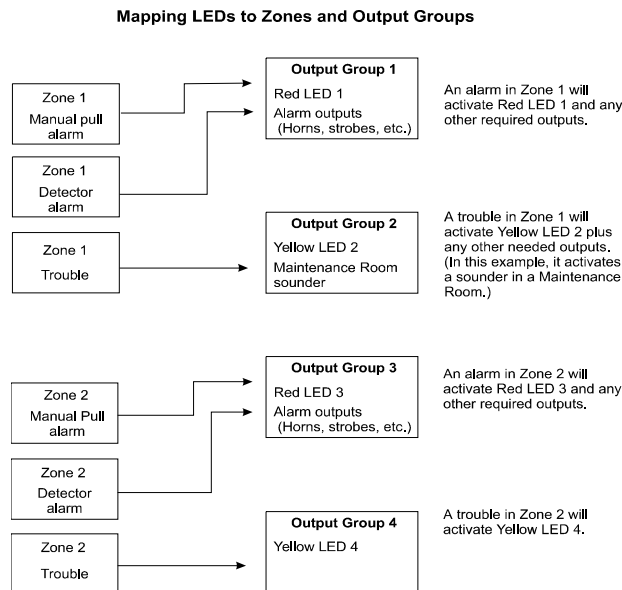

Figure 4-37 5880 Board Layout

4.11.4 Dry Contact Wiring

The 8 input circuits on the 5880 board are for monitoring switch inputs-any type of switch supported by the control panel can be used with the 5880. For example, you can use a 5880 to monitor pull stations, water flow, tamper, reset, or silence switches.

Wire dry contacts as shown in Figure 4-38. Notice grouping of terminals; power terminals are shared by two

inputs.

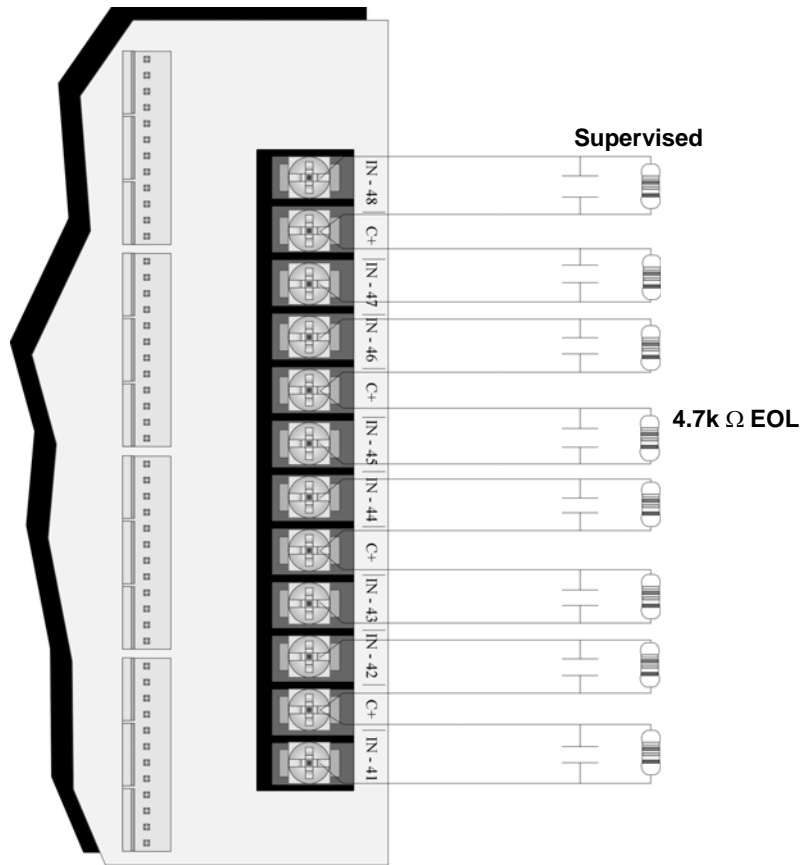

Figure 4-38 Dry Contact Wiring

4.12 5865-3 / 5865-4 LED Annunciator Installation

The 5865-3 and 5865-4 are LED annunciators. The 5865-4 has 30 mappable LEDs, remote silence and reset key switches, and a general system trouble LED. The 5865-3 has 30 mappable LEDs only. These are arranged as 15 pairs of red (typically used for alarm) and yellow (typically used for trouble) LEDs.

Installation of the 5865-5 and 5865-4 is identical. The key switches and the trouble LED follow the behavior of other system annunciators and do not require any installation steps. The following sub-sections describe how to install the 5865-3 and 5865-4 hardware. Refer to Section 6 for programming information.

Note: This manual uses “5865” when referring to aspects of the 5865-3 and 5865-4 that are common to both models.

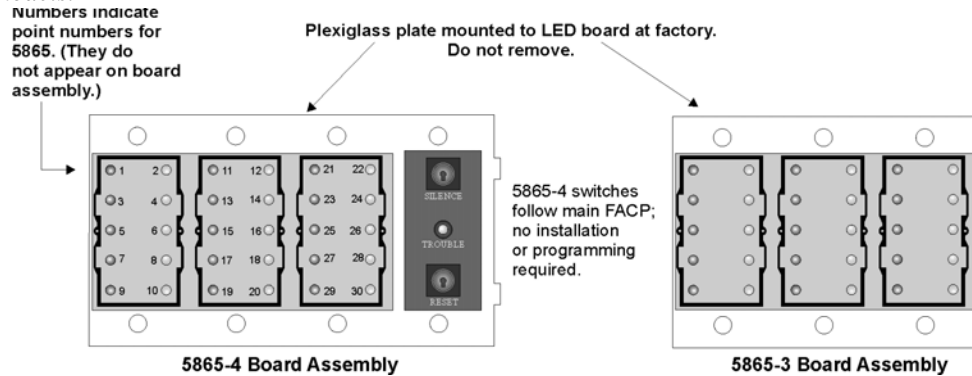

Figure 4-39 5865-3 and 5865-4 Assembly (front view)

4.12.1 5865 Connection to Panel

The 5865 connects to the panel via the SBUS. Make connections as shown in Figure 4-40. After the 5865 is connected to the panel, it must be added to the system. This programming step is described in Section 4.13.

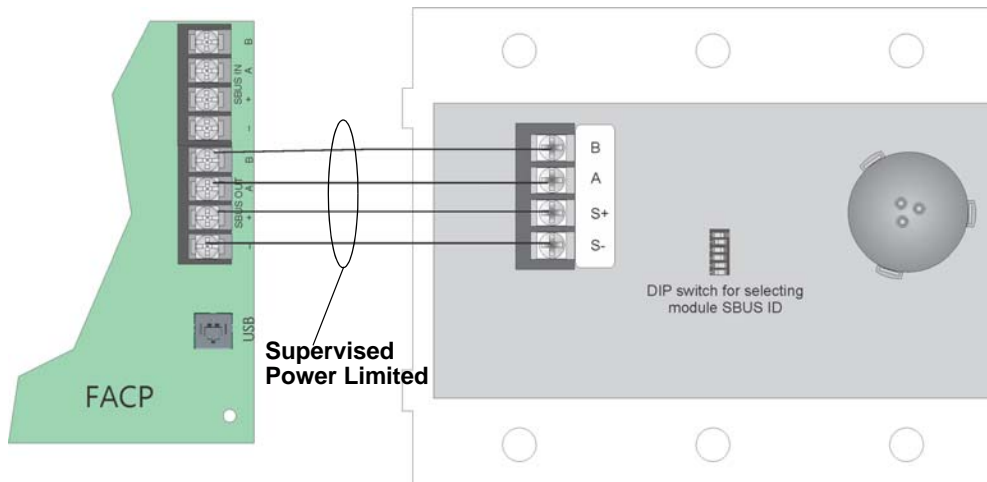

Figure 4-40 5865 Connection to the FACP

4.12.2 5865 Mounting

Mount the 5865-4 to a standard 4-gang electrical box. Mount the 5865-3 to a standard 3-gang electrical box. In

Figure 4-41, the 5865-4 attached to a 4-gang box is used as an example.

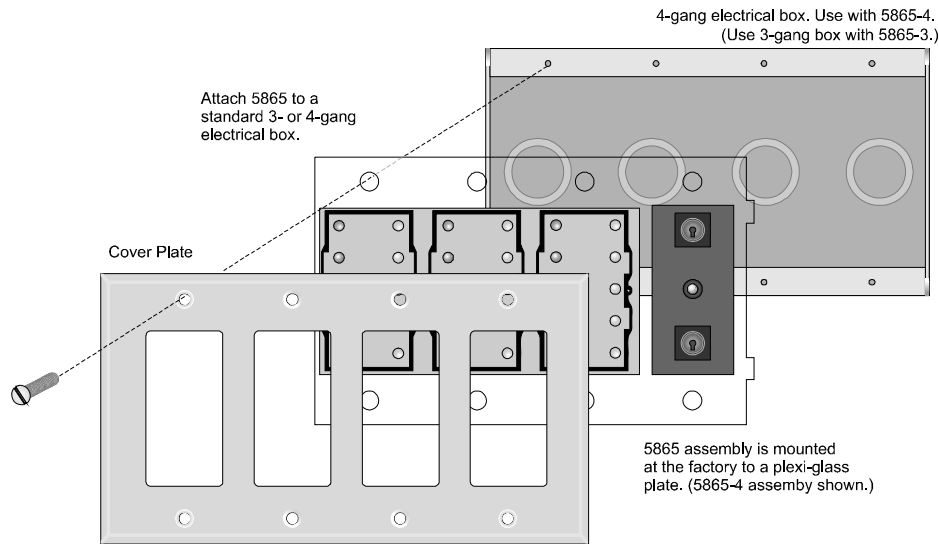

Figure 4-41 5865 Mounting Example

The 5865 ships with a set of zone description labels that can be inserted into the 5865 board assembly. These labels can be used in a typewriter or can be written on by hand. Slide the labels under the plexiglass as shown in Figure 4-42. The LEDs will show through the label when illuminated.

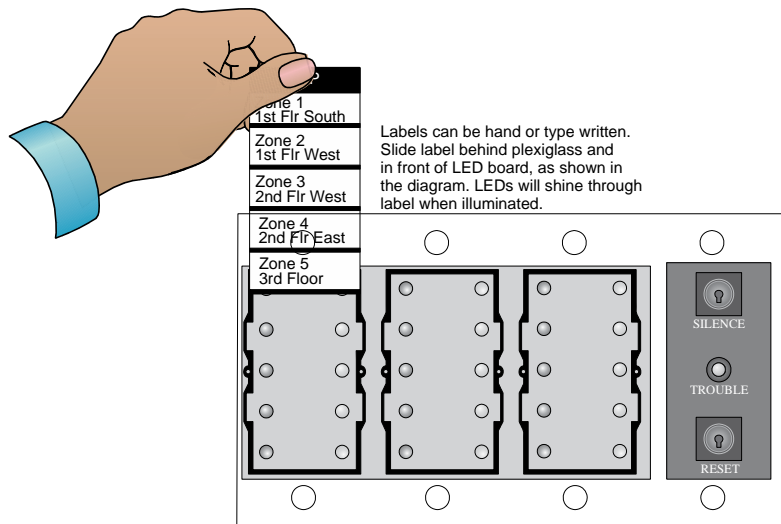

Figure 4-42 Inserting Zone Description Labels

4.13 Configuring SBUS Modules

This section describes how to configure any system hardware modules that have been added to the system.

4.13.1 Assigning SBUS Module IDs

When installing a hardware module (see Table 4-1 for a list of compatible devices), you must use the DIP switches on the module to assign an ID# to the module. Address zero is an invalid address and is not allowed.

Figure 4-43 shows all possible DIP switch positions and their correlation to a numerical ID. For example, to select ID 2, place DIP switch 2 in the up position.

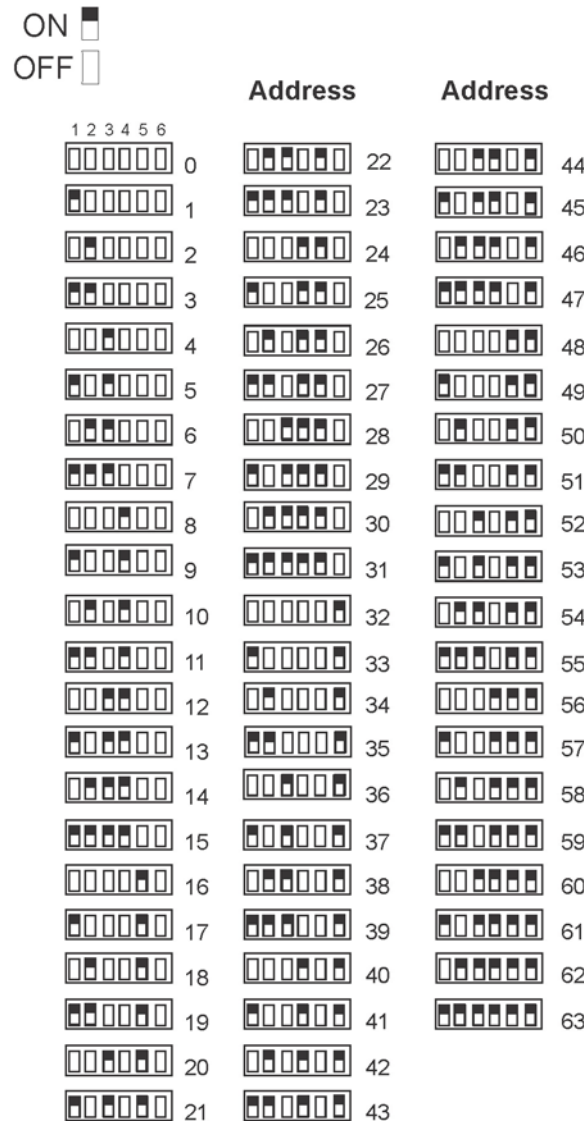

Figure 4-43 Possible module addresses

Refer to Section 9.2 to edit, add, delete, and view module list.

4.13.2 SBUS Bandwidth Considerations

Each SBUS device generates a certain amount of traffic on the SBUS. Generally, the amount of traffic generated depends on the type of SBUS device. To help you figure out the SBUS bandwidth usage of a given collection of devices, a tool is available on the Honeywell Silent Knight website (www.silentknight.com). The tool will serve

as a guide to help determine how heavily loaded an SBUS is with respect to bandwidth. We recommend you use this tool if you plan to have more than eight SBUS devices per SBUS. Remember to include devices that are on 5859XL SBUS repeaters in your list of devices for SBUS bandwidth calculations.

4.14 Telephone Connection

Connect the telephone lines as shown in Figure 4-44. The Model 7860 phone cord is available from Honeywell Silent Knight for this purpose. A number of programmable options are available for customizing telephone lines. These options are described in Section 9.6.

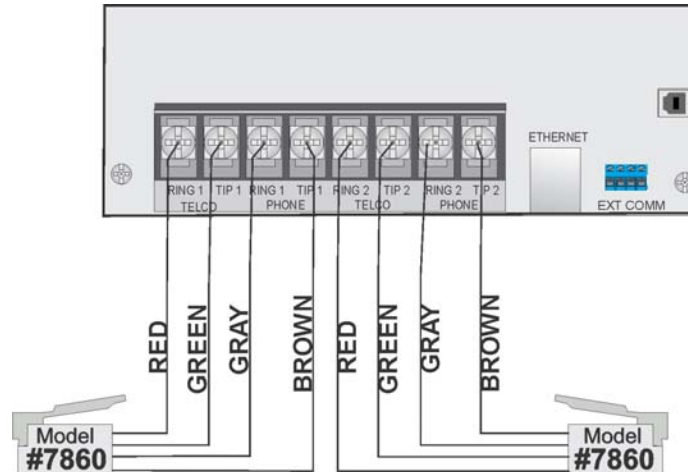

Figure 4-44 Connection of Telephone Lines

4.15 Flexputs™ I/O Circuits

The two Flexput™ circuits are an innovative and versatile feature of the control panel. They can be used as: Class A or B notification circuits, Class A or B initiation circuits (either 2 or 4 wire detectors), or as auxiliary power (resettable, continuous, door holder, or sounder base sync).

The polarity of the Flexput terminals differs depending on whether the circuit is programmed as an input or an output circuit. If the circuit is programmed as an input circuit (for a detector or normally open contact) the X terminal is negative and O terminal is positive. If the circuit is programmed as an output circuit (Aux power or NAC) then the X terminal is positive and the O terminal is negative.

This section of the manual explains how to install conventional notification appliances and initiating devices to be used with the system.

Note: For Flexputs used as NAC circuits refer to Section 4.16

4.15.1 Conventional Input Switch Circuits

This section of the manual explains how to install conventional initiating devices for Class A or Class B configurations.

4.15.1.1 Class B Inputs

You can connect conventional Class B switches, such as waterflow switches and pull stations, directly to the Flexput circuits of the control panel.

To install a Class B switch:

1. Wire the Class B switch as shown in Figure 4-45.

- Configure the circuit through programming (see Section 9.5).

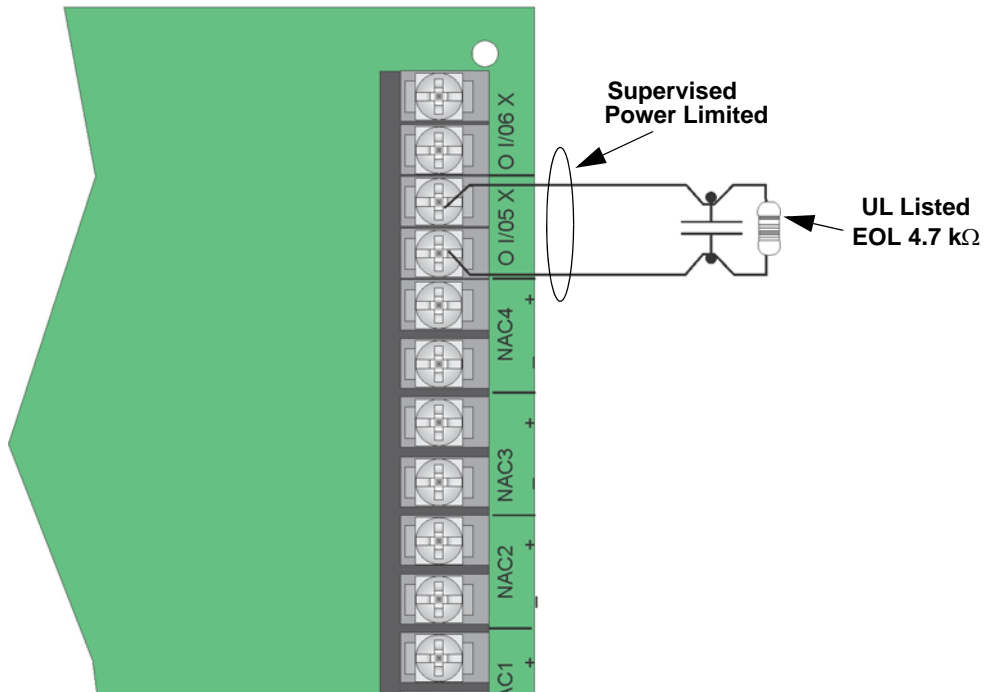

Figure 4-45 Class B Input Switches

4.15.2 Class A Inputs

You can connect conventional Class A switches, such as waterflow switches and pull stations, directly to the Flexput circuits of the control panel.

To install a Class A switch:

- Wire the Class A switch as shown in Figure 4-46.
- Configure the circuit through programming (see Section 9.5).

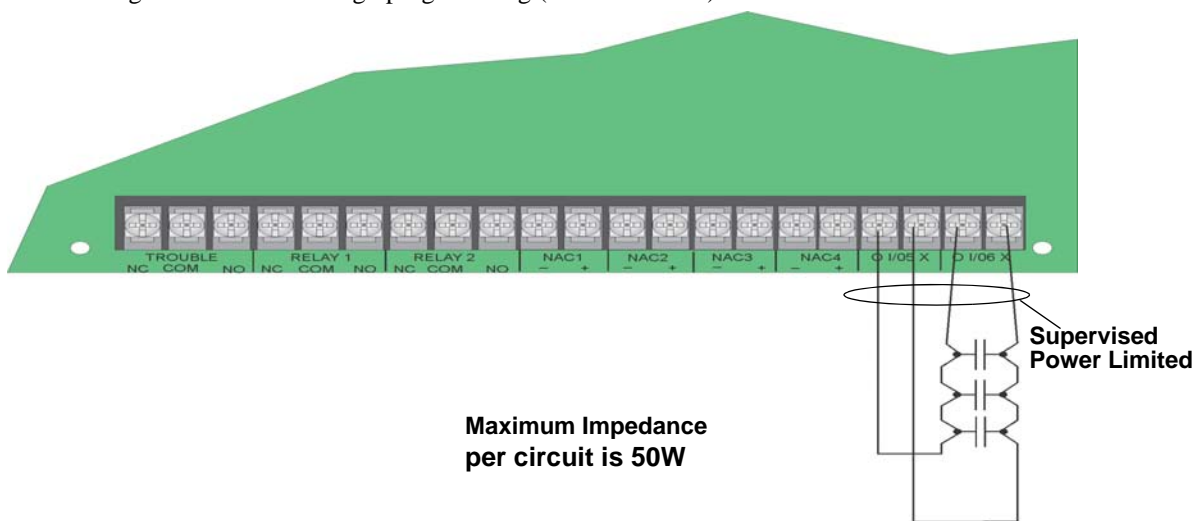

Figure 4-46 Class A initiating Switches

Note: In programming any point that uses multiple Flexput circuits, the lowest Flexput circuit number is used to refer to the circuit pair. In this example, Figure 4-46 uses both Flexput circuit 5 and 6, so in programming it would be referred to as point 5.

4.15.3 Installing 2-Wire Smoke Detectors

Any compatible UL listed two-wire smoke detector can be used with the control panel (see Appendix A for list of compatible smoke detectors). Figure 4-47 and Figure 4-48 illustrate how to connect a UL listed 2-wire detector to the control panel.

4.15.3.1 Installing 2-Wire Class B Smoke Detectors

To install a Class B two-wire smoke detector, wire as shown in Figure 4-47.

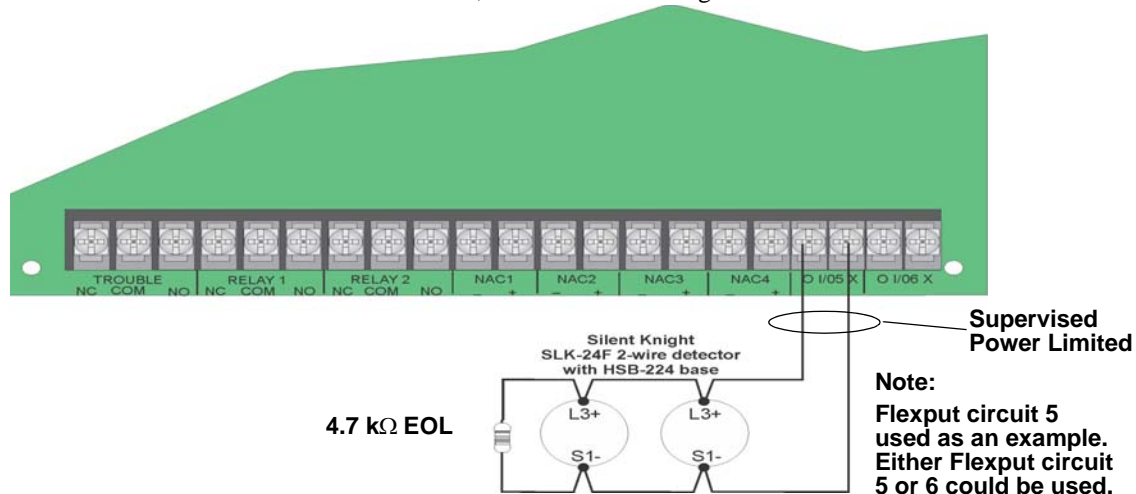

Figure 4-47 Two-Wire Class B Smoke Detector

4.15.3.2 Installing 2-Wire Class A Smoke Detectors

To install a Class A two-wire smoke detector, wire as shown in Figure 4-48.

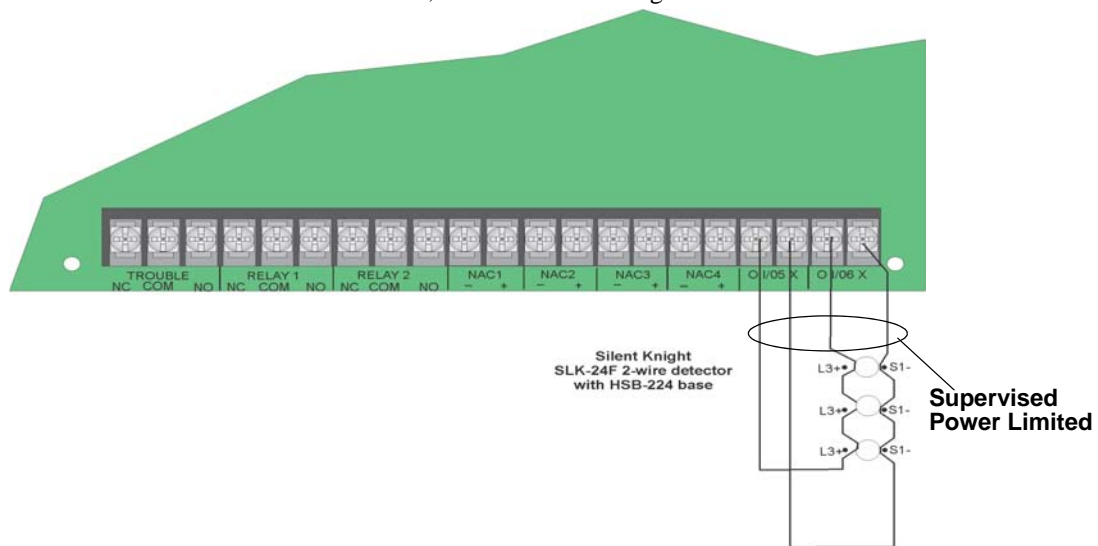

Figure 4-48 Two-Wire Class A Smoke Detector Connections

Note: In programming any point that uses multiple Flexput circuits, the lowest Flexput circuit number is used to refer to the circuit pair. In this example, Figure 4-48 uses both Flexput circuit 5 and 6, so in programming it would be referred to as point 5.

4.15.4 Installing 4-Wire Smoke Detectors

Any compatible UL listed four-wire smoke detector can be used with the control panel (see Appendix A for list of compatible smoke detectors). Figure 4-49 and Figure 4-50 illustrate how to connect a UL listed four-wire detector to the control panel.

4.15.4.1 Installing 4-Wire Class B Smoke Detectors

Figure 4-49 illustrates how to install a 4-wire Class B smoke detector.

Conventions used for wiring 4-wire Class B loops:

1. One Class B 4-wire smoke detector loops can be connected to the control panel.
2. The Class B loop input is paired with a unique power source as shown in Figure 4-49.
3. The detector gets smoke power from Flexput 6 circuit and the contact input is connected to Flexput 5 circuit.

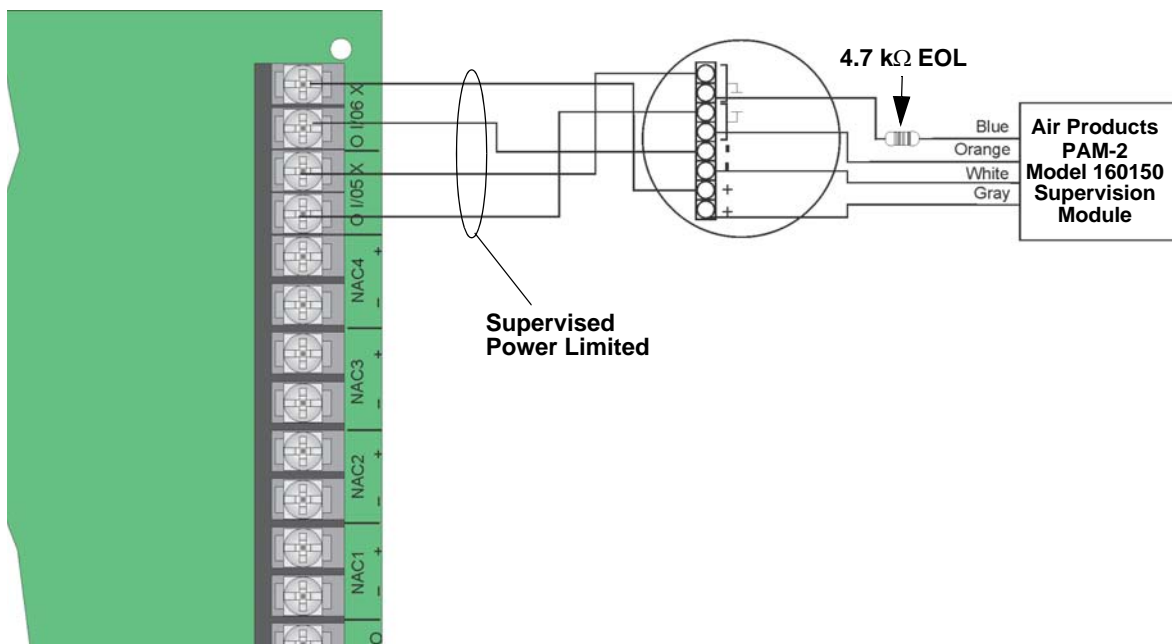

Figure 4-49 Class B 4-Wire Smoke Detector Connections

Note: In programming any point that uses multiple Flexput circuits, the lowest Flexput circuit number is used to refer to the circuit pair. In this example, Figure 4-49 uses both Flexput circuit 5 and 6, so in programming it would be referred to as point 5.

4.15.4.2 Installing 4-Wire Class A Smoke Detectors

Figure 4-50 illustrates how to install a 4-wire Class A detectors.

Conventions used for wiring 4-wire Class A loop:

1. One Class A 4-wire loop can be connected to the control panel.

- Smoke power is supplied to each Class A loop as shown in Figure 4-50.

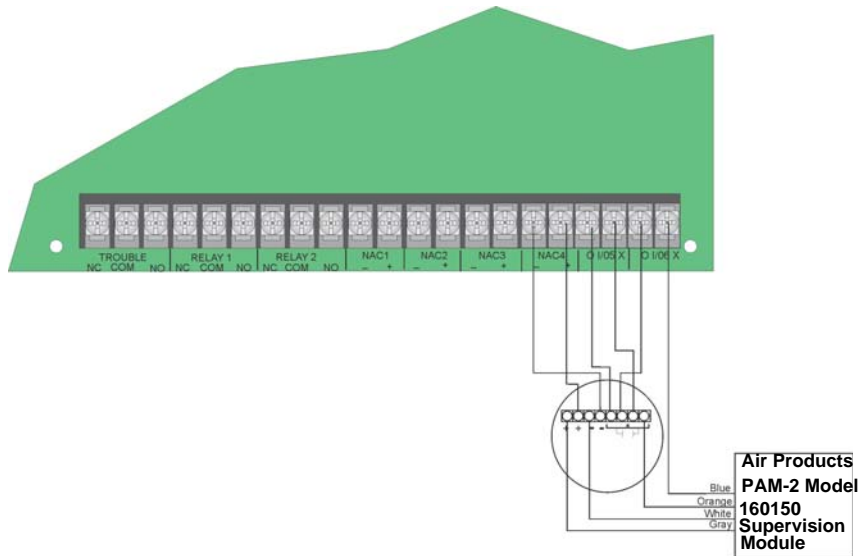

Figure 4-50 Class A 4-Wire Smoke Detector Connections

Note: In programming any point that uses multiple Flexput circuits are always referred to as the lowest Flexput circuit number used. In this example, Figure 4-50 uses Flexput circuits 5, 6 together with NAC 4. In programming (4, 5, 6) would be referred to as point 5.

4.16 Conventional Notification Appliance

This sub-section of the manual explains how to install conventional notification appliances for Class A and Class B configurations.

4.16.1 Class B Notification Wiring

You must use an appliance from the list of compatible appliances in the Appendix A at the back of this manual.

To install a Class B Notification appliance circuit:

1. Wire Class B Notification appliances as shown in Figure 4-51.
2. Configure the circuit through programming (see Section 9.5).

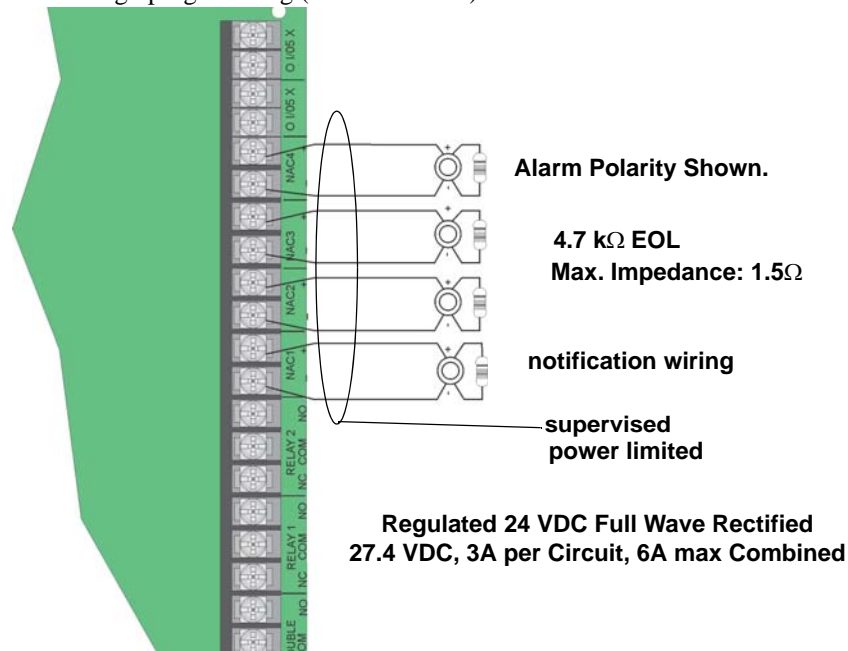

Figure 4-51 Class B Notification Appliance Circuit Wiring

Maximum voltage drop is 3V per Class B notification. See Table 4-4.

Table 4-4: Maximum Impedance Class B

Current	Maximum Impedance
1.0A	3Ω
1.5A	2Ω
2.0A	1.5Ω
2.5A	1.2Ω
3.0A	1.0Ω

4.16.2 Class A Notification Wiring

You must use an appliance from the list of compatible appliances in the Appendix A in the back of this manual.

To install a Class A notification appliance circuit:

1. Wire the Class A notification appliances as shown in Figure 4-52.

Caution

For proper system supervision do not use looped wire under terminals marked – and + of the NAC connectors. Break wire runs to provide supervision of connections.

2. Configure the circuit for Class A in programming (see Section 9.4.1).

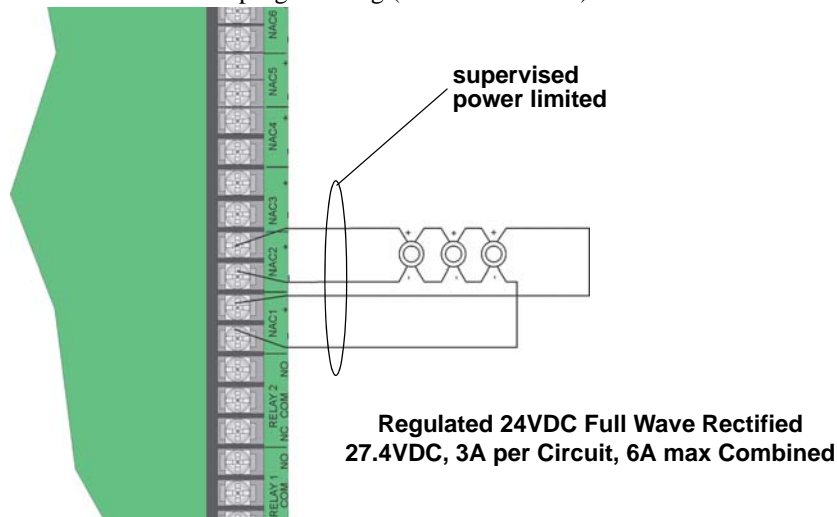

Figure 4-52 Class A Notification Appliance Circuit Configuration

Note: In programming any point that uses multiple NAC circuits, the lowest circuit number is used to refer to the circuit pair. In this example, Figure 4-52 uses both NAC circuit 1 and 2, so in programming it would be referred to as point 1.

Maximum voltage drop is 3V per Class A circuit. See Table 4-5.

Table 4-5: Maximum Impedance Class

Current	Maximum Impedance
1.0A	3Ω
1.5A	2Ω
2.0A	1.5Ω
2.5A	1.2Ω
3.0A	1.0Ω

4.16.3 Auxiliary Power Installation

Circuits 1-6 on the control panel can be used as auxiliary power circuits. The four types of auxiliary power available are:

- Door Holder (see section 4.16.3.1)
- Constant (see section 4.16.3.2)
- Resettable Power (see section 4.16.3.3)
- Sounder Sync Power (see Section 4.16.3.4)

Auxiliary power circuits are power limited. Each circuit can source up to 3A (total current for all circuits must not exceed 6A).

To install an auxiliary power circuit:

1. Wire the circuit(s) that will be used for auxiliary power.
2. Configure the auxiliary power output through programming (see section 9.5).

4.16.3.1 Door Holder Power

Door holder power is intended for fire door applications. When there are no fire system alarms in the system and the panel has AC power, door holder circuits have 24 volt power present at their terminals. Any fire system alarm will cause power to disconnect. Power will be re-applied when the fire system is reset. If AC power is not present, the auxiliary door holder power will be disconnected to conserve the battery backup. When AC power is restored, power is immediately restored to the door holder circuits.

4.16.3.2 Constant Power

Use constant power for applications that require a constant auxiliary power source. Power is always present at Constant circuits.

4.16.3.3 Resettable Power

Resettable power is typically used to power beam detectors, flame detectors and conventional 4-wire smoke detectors. For circuits selected as Resettable, 24-volt power is always present at the terminals unless a system reset occurs. If a system reset occurs, power is disconnected from the terminals for 30 seconds, then re-applied.

4.16.3.4 Sounder Sync Power

Sounder Sync Power continuously outputs the System Sensor synchronization pattern and is intended for use with B200S sounder bases.

4.17 On-Board Relays (Conventional)

The control panel has two built-in programmable relays and a built-in trouble relay. All relays are Form C rated at 2.5 A @ 24 VDC.

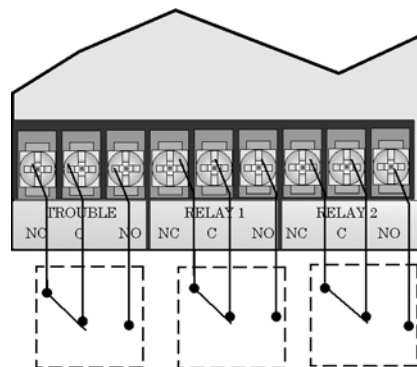

Figure 4-53 Location of Conventional Relay Circuits

4.17.1 Trouble Relay

The control panel has a dedicated Form C trouble relay built into terminals labeled TROUBLE. The relay provides a normally open and a normally closed contact. The trouble relay will deactivate under any trouble condition.

Note: The NC contact is relay contact that is closed when the panel has power and there are no trouble conditions.

4.17.2 Programmable Relays

The control panel has two Form C programmable relays built into terminals labeled RELAY and RELAY 2. Each relay provides a normally open and a normally closed contact.

To install one or two programmable relays, follow these steps.

1. Wire Relay 1 and/or Relay 2 as needed for your application. See Figure 4-53 for the location of the relay terminals.
2. Configure the relay through programming (see Section 9.5).

4.18 Remote Station Applications

4.18.1 Keltron Model 3158 Installation

The control panel is compatible with Keltron Model 3158, used for direct connection to a Keltron receiver. The 3158 reports alarms, supervisories, and troubles.

The steps for connecting the 3158 to the control panel. Refer to the 3158 installation instructions for complete information.

1. Wire the 3158 to the control panel as shown in the connection list.
2. Wire the 3158 within 20 feet of the control panel. Wiring must be enclosed in conduit.
3. Program control panel Relay 1 for alarm.
4. Program circuit 1 for alarm.
5. Program circuit 2 for supervisory non latching.

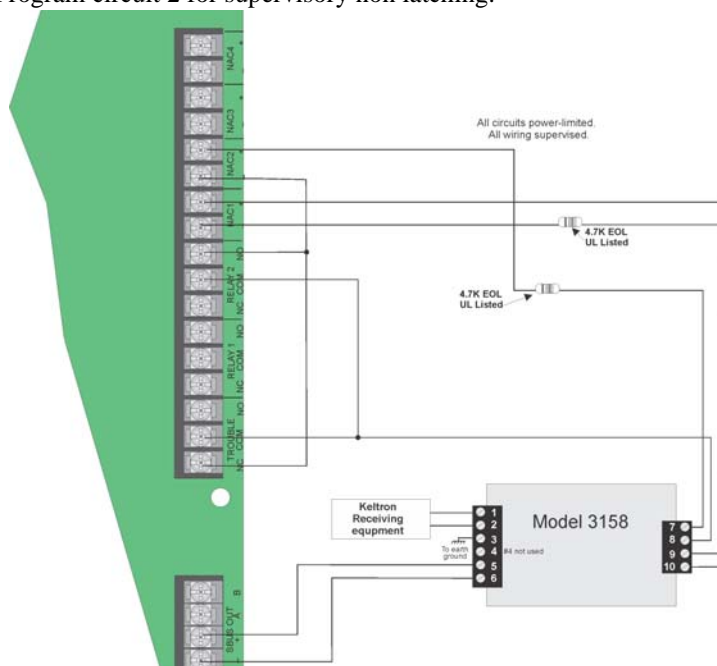

Not suitable for remote station protected premises service where separate transmission circuits are required for fire supervisory (if applicable), and trouble signals. Intended for connection to a polarity reversal circuit of a remote station receiving unit having compatible ratings.

Figure 4-54 Keltron 3158 Connection to FACP

4.18.2 City Box Connection Using the 5220 Module

This section describes how to connect the control panel to a local energy municipal fire alarm box or “city box” as required by NFPA 72 Auxiliary Protected Fire Alarm systems for fire alarm service. The city (master) box is

an enclosure that contains a manually operated transmitter used to send an alarm to the municipal communication center which houses the central operating part of the fire alarm system.

City Box Standby Current: 0 (Notification supervision current accounted for in control panel draw).

Alarm Current: 1 Amp for 1 second 27.2 VDC max

The maximum coil and wire resistance (combined) must not exceed 30 ohms.

To install the 5220 for city box connection:

1. Use one of the knockouts on the right side of the control panel to connect the 5220 using a short piece of conduit (must not exceed 20 feet in length).
2. Wire the 5220 to the control panel as shown in Figure 4-55. This drawing also shows how to connect the city box coil to terminals 3 and 4 on the 5220.
3. Connect earth ground wire to the 5220 chassis with mounting screw.
4. Program the NAC circuit used as a notification circuit, continuous and non-silencing. Refer to Section 9.5 for point programming, Section 9.4 for group settings, and Section 9.3 for zone settings and mapping.

It is not possible to reset the remote indication until you clear the condition and reset the control panel.

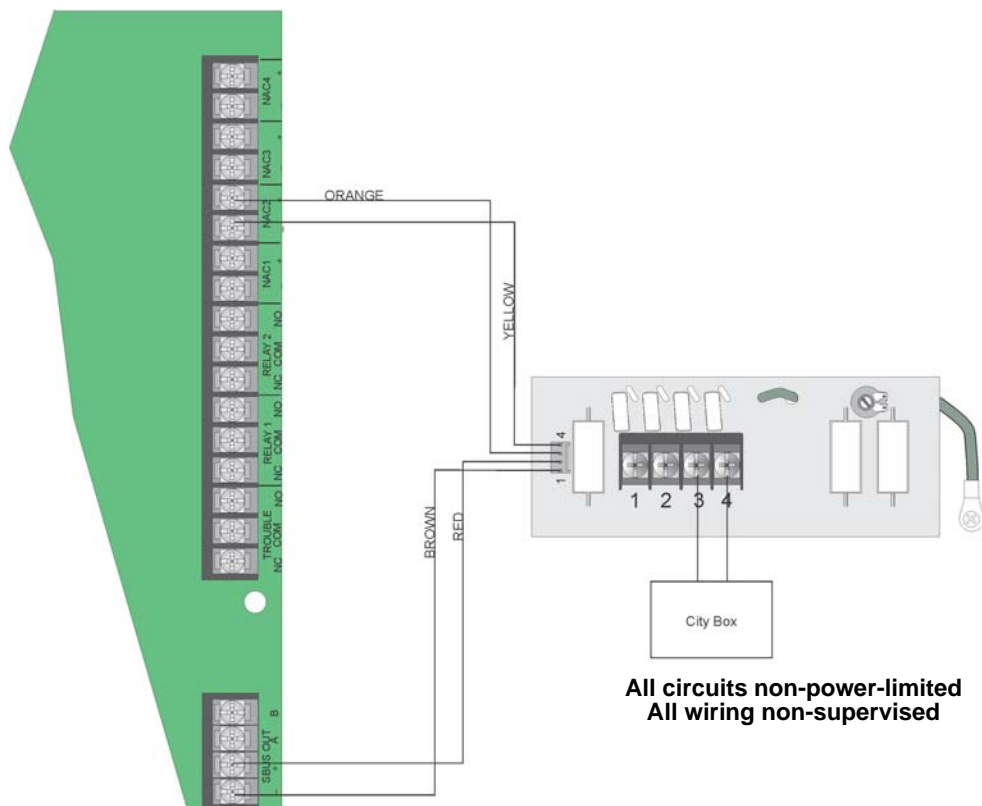

Figure 4-55 City Box Connection

4.18.3 Using the Addressable Relay Module for City Box Connection

Wire the SK-Relay as shown in Figure 4-56.

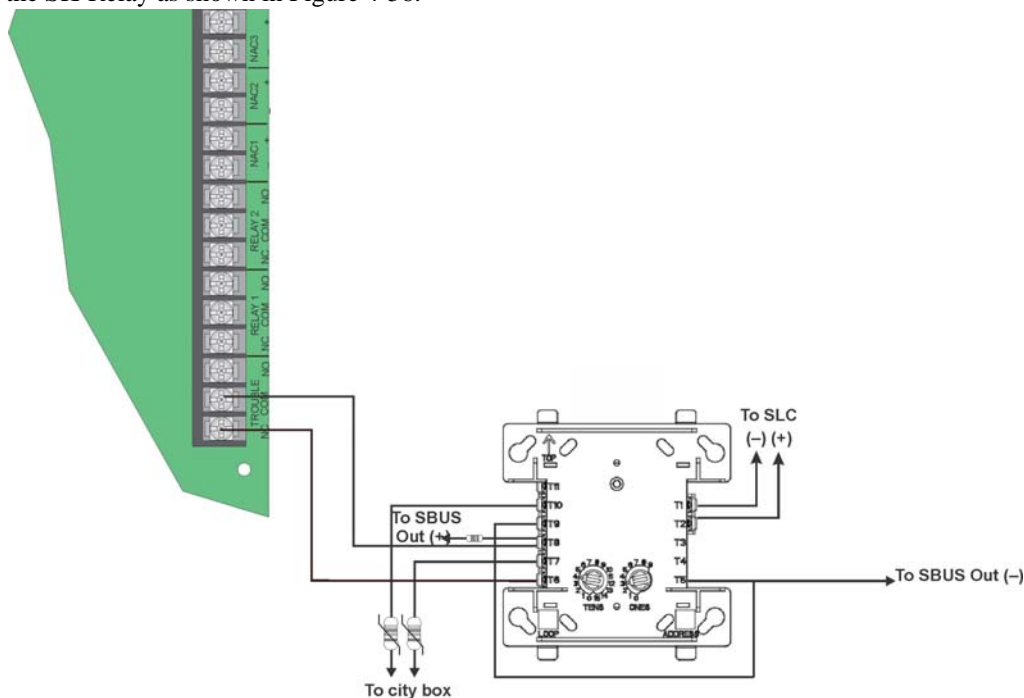

Figure 4-56 Relay Module for City Box Connection

4.18.4 NFPA 72 Polarity Reversal

Note: Intended for connection to a polarity reversal circuit of a control unit at the protected premises having compatible rating.

4.18.4.1 Using the 5220 Module

When the 5220 is wired and programmed for polarity reversal, it reports alarm and trouble events to a remote site. Alarms will override trouble conditions and it will not be possible to reset the remote indicator until the condition is cleared and the control panel is reset.

If an alarm condition occurs, the alarm relay will close, overriding the trouble condition.

Standby Current: 100 mA, 24 VDC

Alarm: 100 mA, 24 VDC

To install the 5220 for polarity reversal, follow the steps below:

1. Locate the knockout on the right side of the control panel cabinet to connect the 5220 using a short piece of conduit (must not exceed 20 feet in length).
2. Wire the 5220 to the control panel using the four-wire pigtail provided as shown in Figure 4-57. This diagram also shows how to connect the 5220 to the remote indicator.
3. Connect earth ground wire to the 5220 chassis with mounting screw.
4. Program the circuit used as a notification circuit, continuous and non-silencing. Refer to Section 9.5 for point programming, Section 9.4 for group settings, and Section 9.3 for zone settings and mapping.

- If necessary, adjust loop current using the potentiometer (R10) on the 5220 board. Normal loop current is 2-to-8 mA with a 1k ohm remote station receiving unit. Maximum loop resistance is 3k ohm.

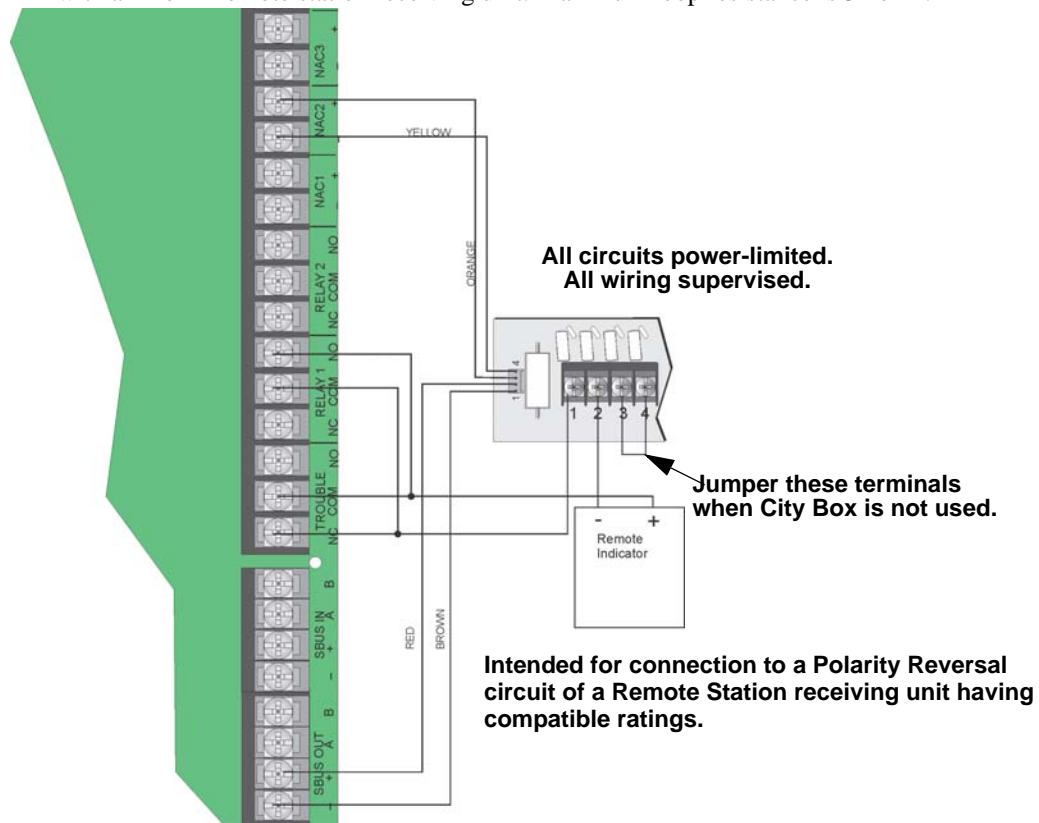

Figure 4-57 Polarity Reversal Connection Using the 5220 Module

4.18.4.2 Using the 7644-L8 Module

When the 7644-L8 is used for polarity reversal, it allows alarm and trouble events to be reported to a remote site. Alarms will override trouble conditions and it will not be possible to reset the remote indicator until the condition is cleared and the control panel is reset.

To install the 7644-L8 for polarity reversal:

- Wire the 7644-L8 to the control panel as shown in Figure 4-58. Do not install an EOL resistor on the terminals of the circuit used.
- Program the circuit as a notification circuit.
- Map the group to activate constant on from the zone event. See Section 9.3.1.3.

4. Program the output group characteristics as non-silenceable and reverse polarity. See Section 9.4.1.2.

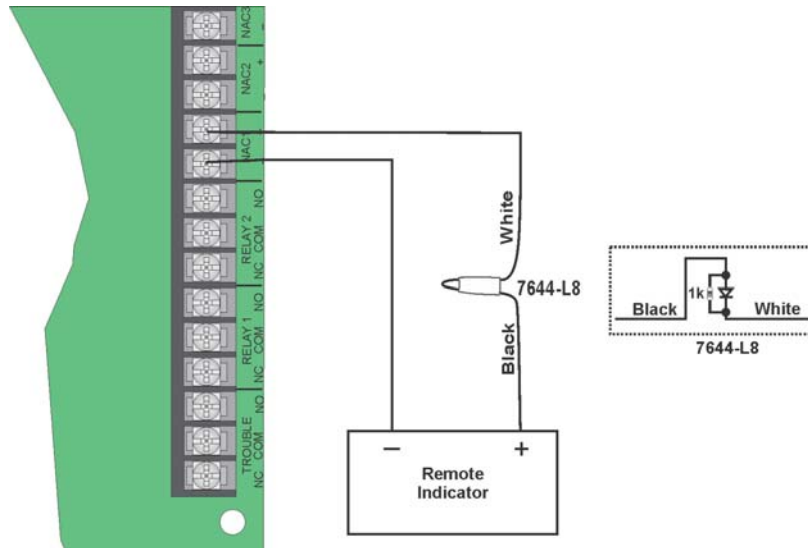

Figure 4-58 Polarity Reversal Connection Using the 7644-L8

4.18.5 Transmitter Activated by Dry Contacts

This section describes the connection of a UL 864 listed remote station transmitter to the 6820/6820EVS FACP dry contacts. The FACP contacts must be supervised by the remote station transmitter module using end-of-line resistors (ELRs) with a value determined by the transmitter manufacturer. Power is also provided by the remote station transmitter manufacturer. Refer to the remote station transmitter manufacturer’s manual for details.

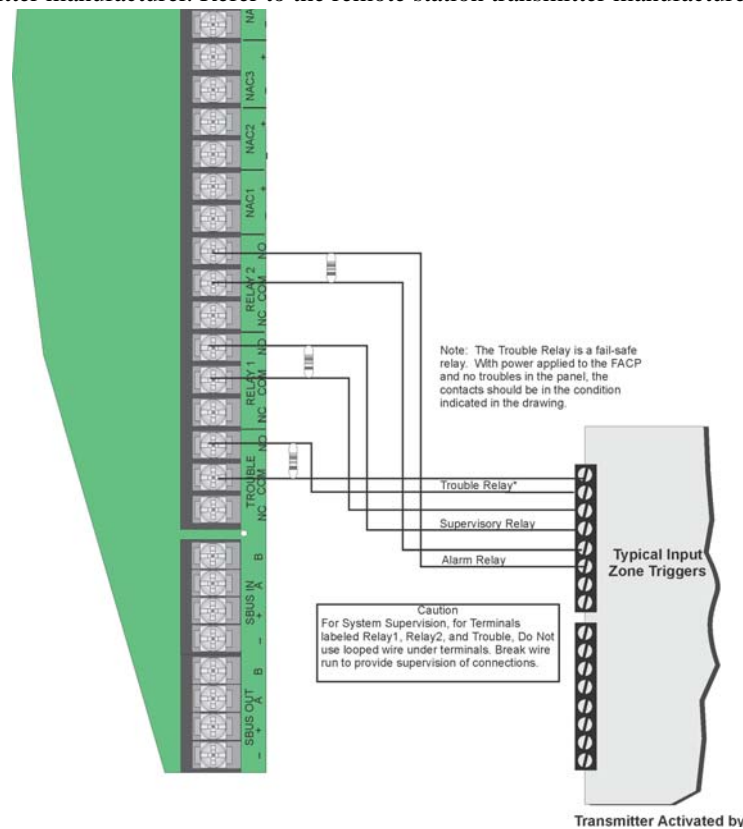

Figure 4-59 Transmitter Activated by Dry Contacts

Section 5

Common Communication Link

5.1 Hardware Features

6820/EVS panels can be networked to create a virtual system that is larger than 1,110 addressable points. Each additional 6820/EVS provides another 1,110 addressable points to the network total. For example, a network of 17- 6820/EVS panels provides a maximum addressable point capacity of 18,870 points ($1,110 \times 17 = 18,870$ SK devices).

5.1.1 Panels

6820/EVS and other applicable addressable panels can be linked together for common communications to the central station. “Sites” are used to allow for individual or common annunciation across the link. Up to 17 sites can be activated and programmed for the link.

5.1.2 Wiring Options to Connect Panels

1. Fiber Optic Single Mode - must use the SK-NIC and SK-FSL for up to 30dB loss of signal separation. SK-FSL connects to the link using 9/125 micron single-mode fiber
2. Fiber Optic Multi-Mode - must use the SK-NIC and SK-FML for up to 8dB loss of signal separation. SK-FML connects to the link using 62.5/125 micron multi-mode fiber
3. Twisted Pair Copper Wire - must use the SK-NIC to provide up to 3000 feet of separation.

All methods of panel connectivity can be used within the same linked system.

5.2 SK-NIC Connection Options

When linking a group of 6820/EVS's you must use the SK-NIC to link the panels together. See Figure 5-1 and Figure 5-2, for Internal mounting or external mounting of SK-NIC option.

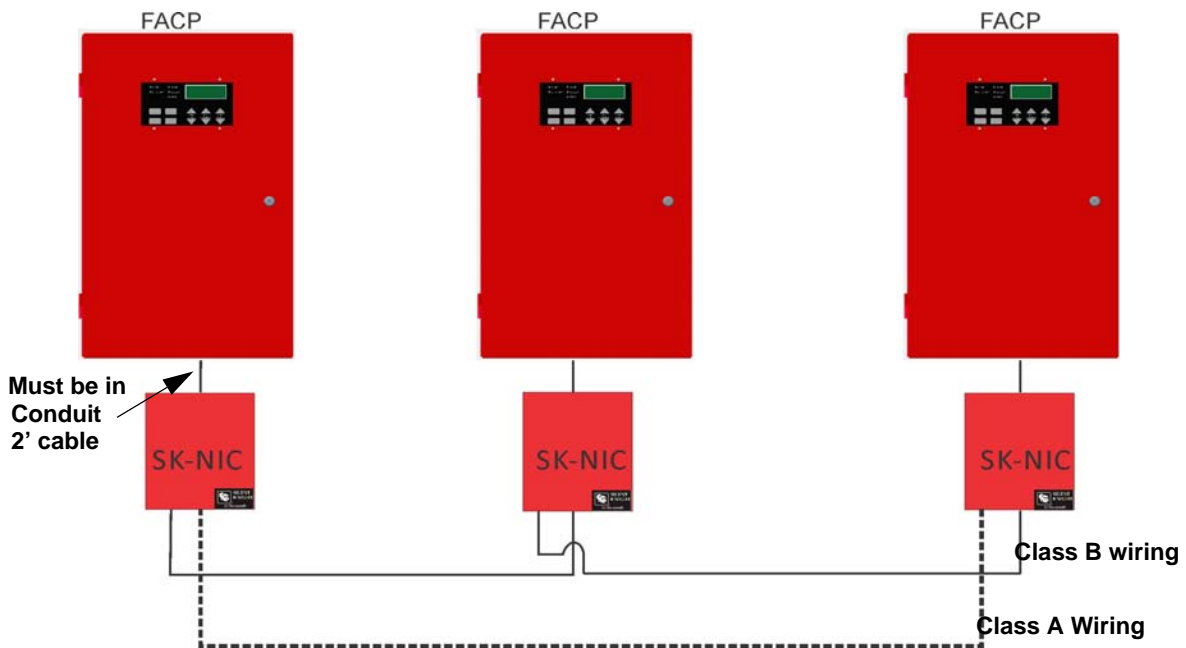

Figure 5-1 EXTERNAL SK-NIC Wiring Option

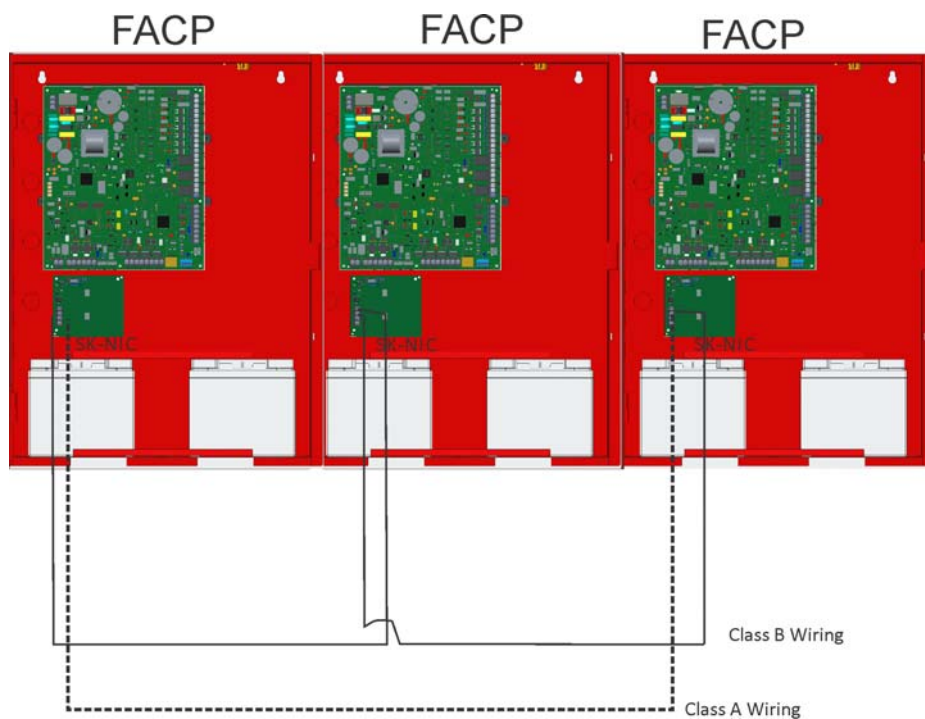

Figure 5-2 Internal SK-NIC Wiring Option

5.3 SK-NIC Wiring Options

Linking a group of 6820/EVS requires the use of a SK-NIC network interface card with each panel. The SK-NIC connects to other linked units using unshielded, twisted-pair wiring or fiber-optic cable.

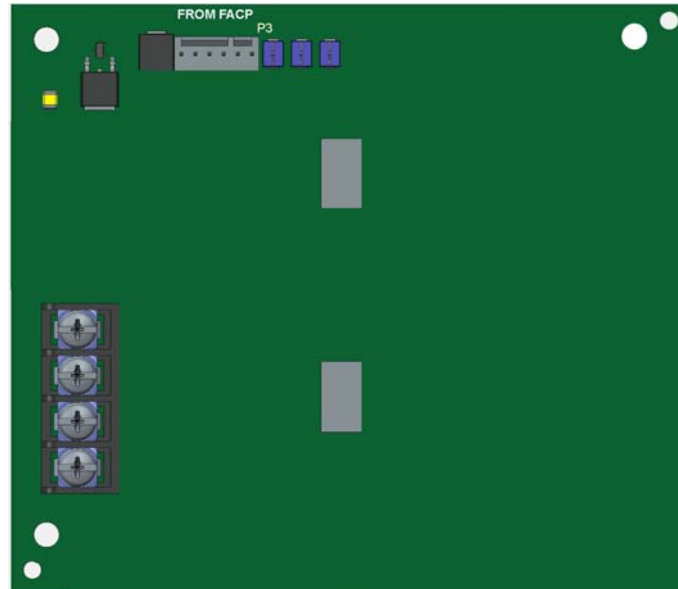

Figure 5-3 SK-NIC Network Interface Card

5.3.1 Fiber Loop Modules

Two types of fiber optic modules are available to use to transmit and receive communication with the SK-NIC. See Figure 5-4. For more information see SK-FML / SK-FSL installation sheet P/N LS10178-001SK-E.

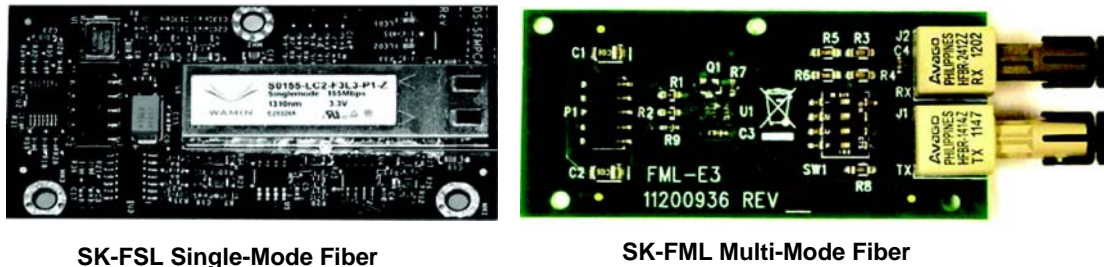

Figure 5-4 Types Fiber Loop Modules

The SK-FML (Fiber-Optic Multi-Mode) and SK-FSL (Fiber-Optic Single-Mode) are plug-in fiber loop modules. The two types of fiber optic modules are used as one channel to transmit or receive communications with the SK-NIC, ARCNET communication circuit.

The following describe the two types of fiber optic modules.

- The SK-FML is a fiber module that allows the multi-mode fiber to be linked between nodes.
- The SK-FSL is a fiber module that allows the single-mode fiber to be linked between nodes.

Each fiber loop module can Transmit (TX) and Receive (RX) fiber-optic cable connecting to the SK-NIC. Up to two fiber loop cards can be added to the SK-NIC, and both cards may be combined in the same configuration.

See Figure 5-5.

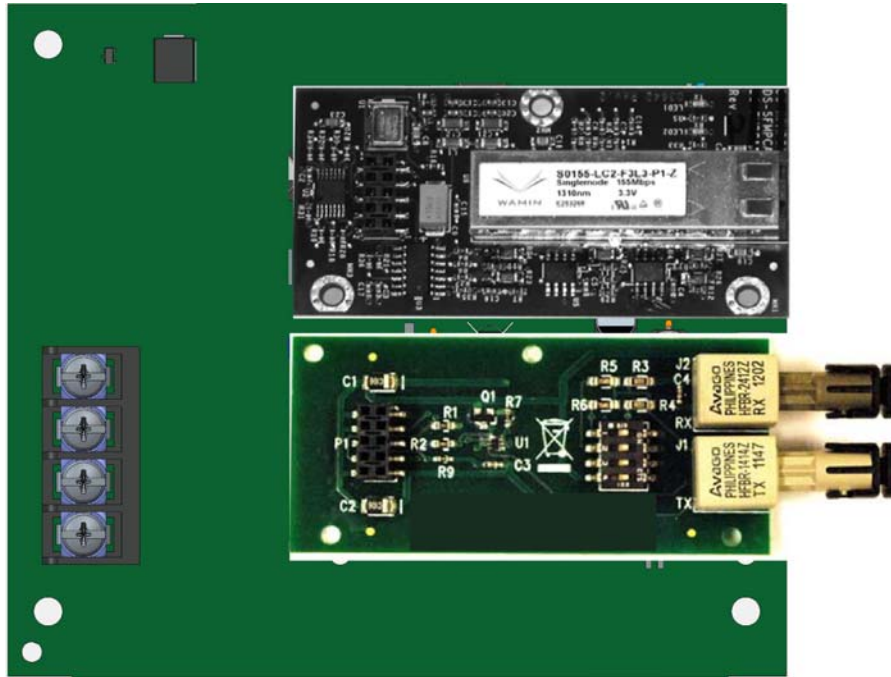

Figure 5-5 SK-NIC with Fiber Loop Modules

5.3.1.1 SK-NIC-KIT Mounting Kit

SK-NIC can be mounted within the 6820/EVS cabinet or in the SK-NIC-KIT accessory cabinet. The SK-NIC-KIT includes the SK-NIC, cabinet with door, cable, & mounting hardware. The accessory kits are available if you want to install the SK-NIC outside of the 6820/EVS cabinet.

5.3.2 SK-NIC Installation

The SK-NIC is designed to mount on one of the SLC expander standoff sets inside the cabinet or remotely using the SK-NIC-KIT.

Use the following steps to properly mount the SK-NIC inside the 6820 or 6820EVS.

1. Place the SK-NIC on one of the SLC expander standoff sets.

- Use the 6-pin cable included with SK-NIC to connect the 6820/EVS to the SK-NIC. Connect the SK-NIC to the pin connector on the control panel labeled Data Network. See Figure 5-6.

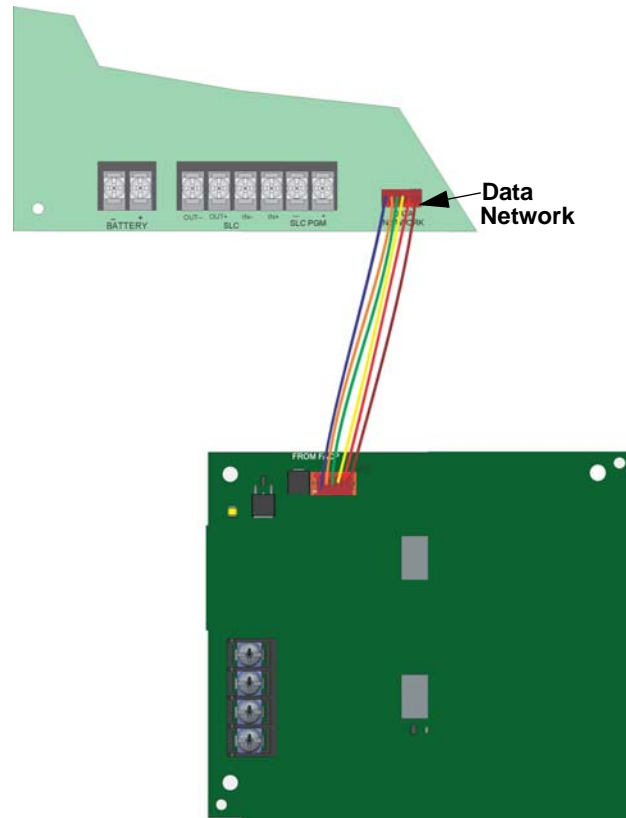

Figure 5-6 Panel to SK-NIC connection

- Each SK-NIC has the ability to monitor for earth ground faults on the twisted pairs connected to Port 1 of its terminal block TB2. Earth fault detection for any wiring at Port 2 of TB2 is done at the next/previous SK-NIC due to these wiring connections being connected to Port 1 of TB2 at the next/previous SK-NIC.
- Unused optic ports on fiber loop modules must have their dust caps placed on the port.
- Based on the type of data medium chosen, run the twisted pair wiring/fiber optic cable to the next SK-NIC using a class B or class A wiring method. A combination of both medium types can be used. See Figure 5-7, Figure 5-8, Figure 5-9, and Figure 5-10 for SK-NIC wiring examples.

To mount the SK-NIC remotely:

Follow the steps above except, The 6-pin cable that runs from the SK-NIC to the 6820EVS must be run in conduit. See Figure 5-1.

Note: *The SK-NIC provides a common communications link for 6820/6820EVS. These panels cannot be linked together for peer-to-peer networking.*

5.3.2.1 Unshielded Twisted Pair Wiring between Multiple Panels

Unshielded twisted pair wiring between multiple panels is shown in Figure 5-7. Class A wiring is shown with a dotted line.

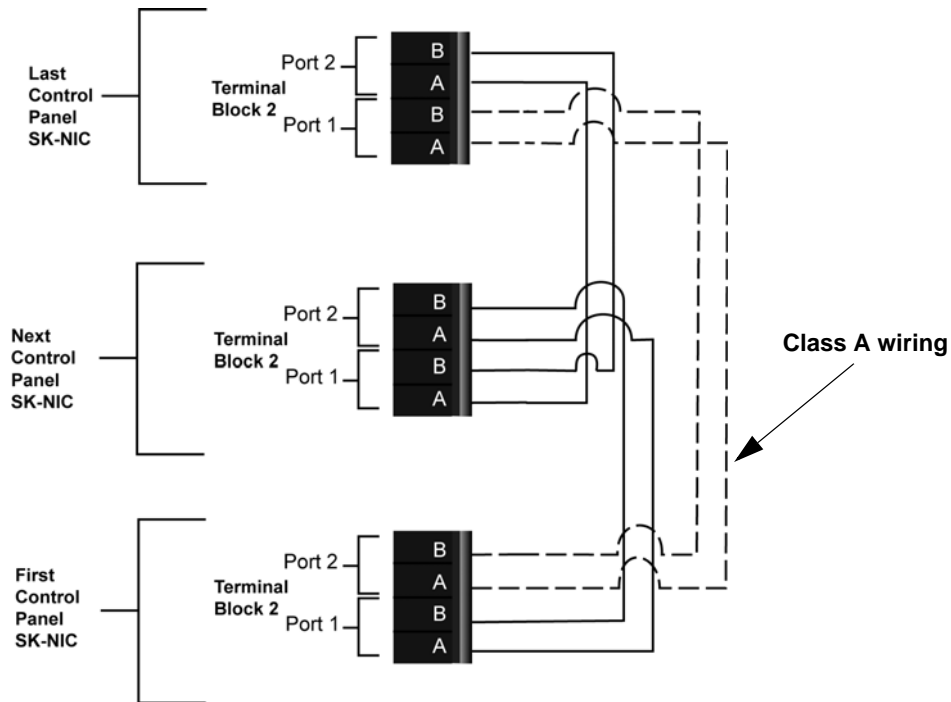

Figure 5-7 Twisted Pair Wiring Configuration

5.3.2.2 Fiber Optic Multi-Mode Wiring between Multiple Panels

Fiber optic cable between multiple panels is shown in Figure 5-8. Class A is shown with a dotted line.

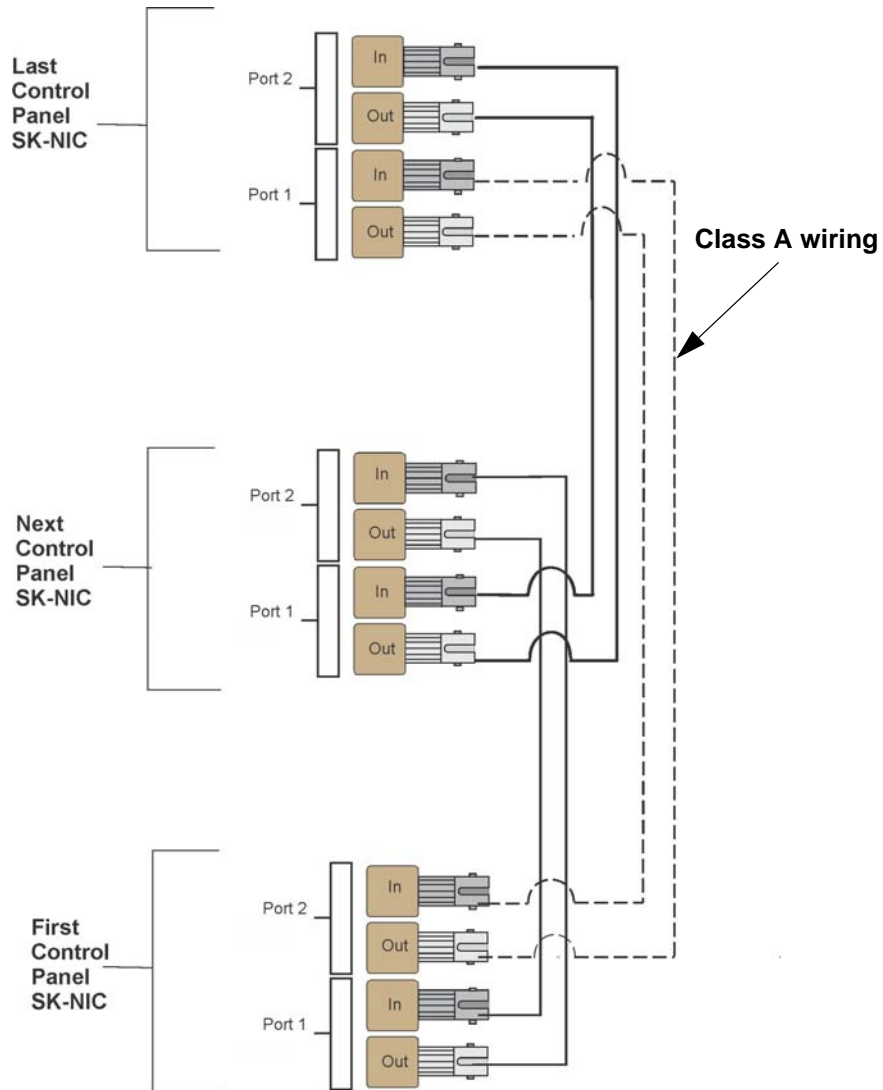

Figure 5-8 Fiber Optic Wiring Example

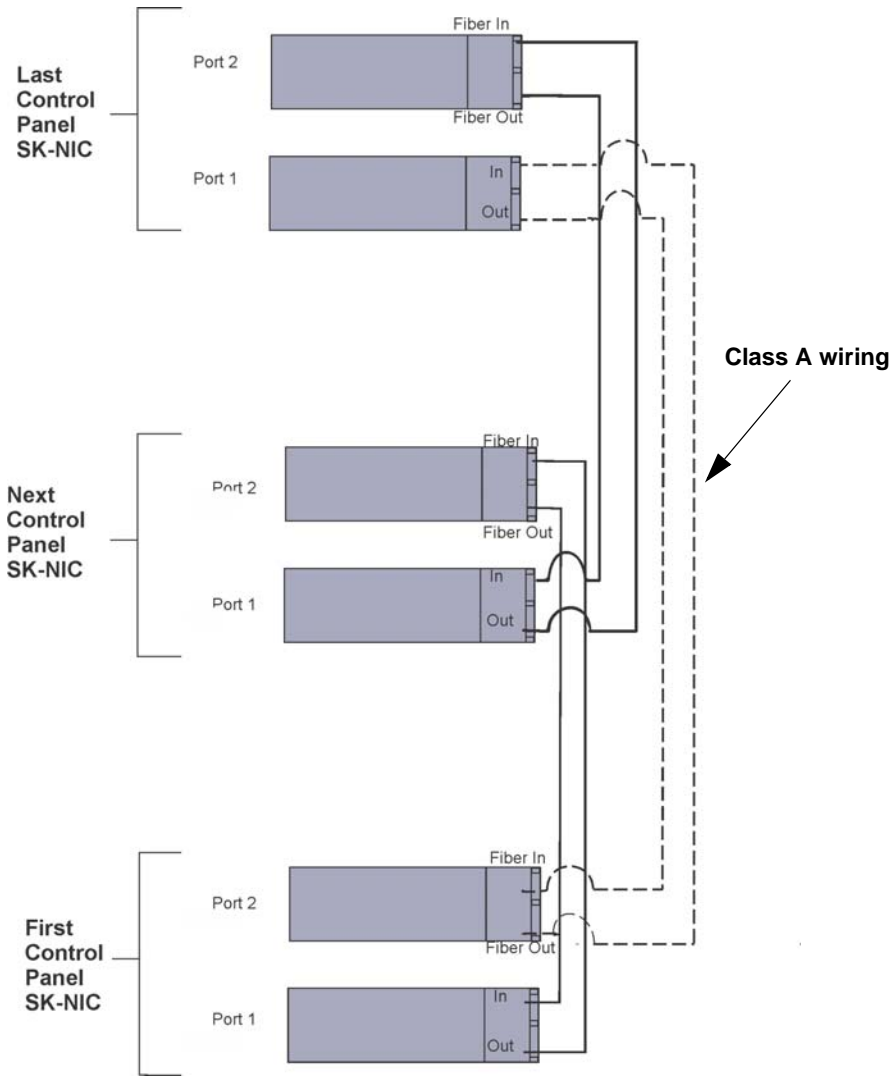

Figure 5-9 Fiber Optic Wiring Single-Mode Example

5.3.2.3 Fiber Optic and Twisted Pair Wiring between Multiple Panels

A mixture of fiber optic cable and twisted pair wiring between multiple panels is shown in Figure 5-10. Class A cabling is shown with dotted line.

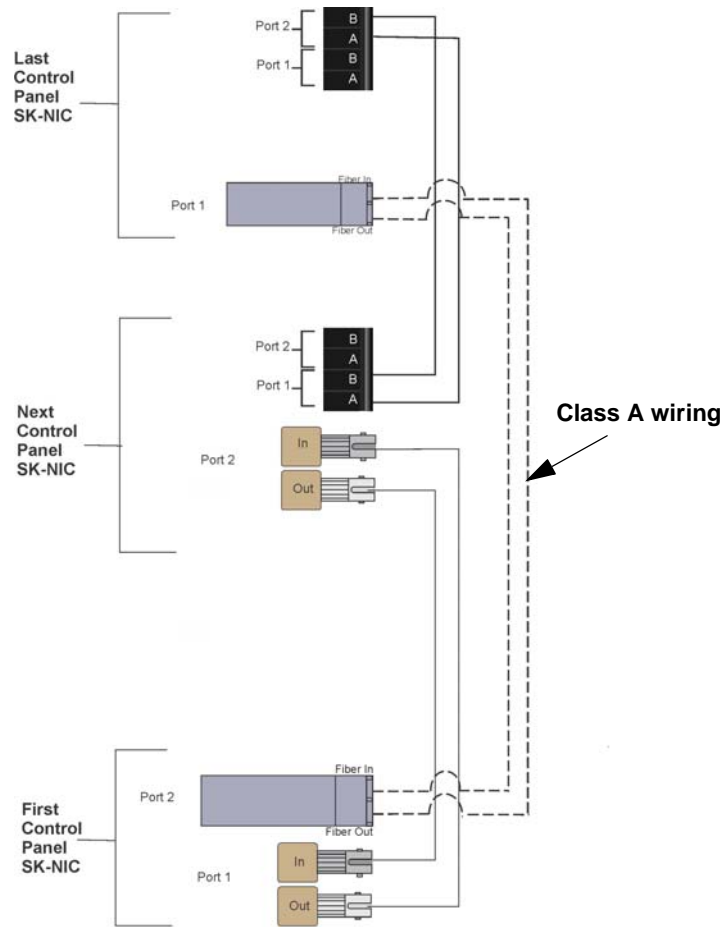

Figure 5-10 Twisted Pair and Fiber Optic Combination Wiring Example

5.4 Setting the Panel ID for each Panel

Note: It is important that much thought is given when choosing the panel IDs for each panel. It is difficult to change the IDs once panel programming has begun.

The panel ID for each panel is set using DIP switch positions 1 through 5. See Figure 5-11 below for possible DIP switch settings.

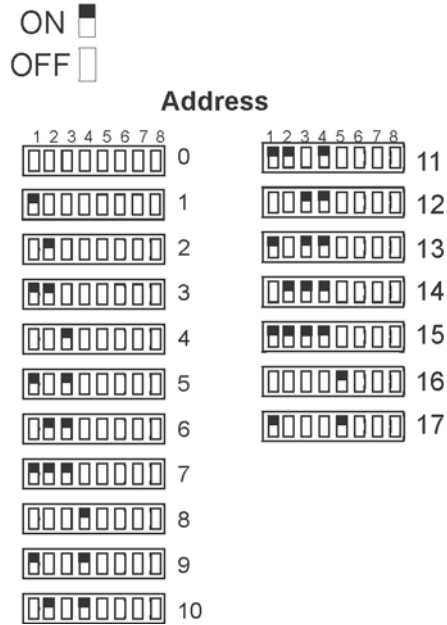

Figure 5-11 ID Settings

Section 6

Network Management

Note: Although the word “Network” is used in this section, it applies to system menus that relate to the physical wire and/or fiber optic connections between multiple panels. The 6820/EVS does not support peer-to-peer networking.

6.1 Network Diagnostics

6.1.1 Ping Panel

The Ping Panel menu allows you to continually ping any panel programmed into the network. As the selected panel is being pinged, the Ping Panel screen will display the reply time, minimum and maximum reply times, and sent and received counters.

1. Enter the Installer Code. The panel will automatically go to the main menu.
2. Select 5 for Network Diagnostics.
3. Press 1 to enter the Ping Panel Menu.
4. Press the up or down arrow key to select Network Panel ID. Press ENTER to Ping panel.

6.1.2 Data Network Status

The Data Network Status screen will display statistics that are indicators of Network performance.

1. Enter the Installer Code. The panel will automatically go to the main menu.
2. Select 5 for Network Diagnostics.
3. Press 2 to enter the Data Network Status menu.

6.2 Network Programming

This section of the manual describes how to program network options using the built-in annunciator. All options described in this section can be programmed using the HFSS Honeywell Fire Software Suite. To edit site assignments, HFSS must be utilized.

6.2.1 Learn Network

The Learn Network menu shows you all of the panels connected to the network. Any panel that has been programmed into the network will appear as a “member.” Any panel that is connected to the network but not programmed into the network will appear as a “guest.” You can add guest panels to the network by changing their status to member in this menu. Panels showing OK are currently responding on the network. Panels not showing OK have either been removed or are not responding due to networking problems. See Section Figure 6.1 for Network Diagnostics.

1. Enter the Installer Code. The panel will automatically go to the main menu.
2. Select 6 for Network Programming.
3. Press 1 to enter the Learn Network menu.
4. Press ENTER to add or remove panels connected to the network as member or guest.

Note: If adding panels to network, the system will automatically run the Sync Network Options. You will be required to select which panel to distribute network options from. See Section 6.4.

6.2.2 Edit Network Names

The Edit Network menu allows you to edit the panel name and edit the panels site name.

To Edit Panel Names:

1. Enter the Installer Code. The panel will automatically go to the main menu.
2. Select 6 for Network Programming.
3. Press 2 to enter the Edit Network Names menu.
4. Press 1 to Edit Panel Name. Choose Panel to edit.

See Appendix B for a list of available characters and their numeric designators.

6.2.3 Edit Panel ID

This menu option allows you to change the current Network Panel ID. It is best to carefully consider the network ID setting for each panel. Take into account any future panels that will be added to the network (future wiring of two buildings together). The Network Panel ID setting has to be unique for each panel on the network.

This menu will allow you to change the currently assigned Network Panel ID to the current Network ID dip switch setting. The system will be down as the panel needs to reboot in order to complete the transition.

When using the PC configuration software to program the panels, the Network Panel ID will be locked from future editing. The only way to change it will be to restore defaults and use this menu again.

To Edit the Network Panel ID:

1. Enter the installer code. The panel will automatically go to the main menu.
2. Select 6 for Network Programming.
3. Press 3 to enter the Edit Panel ID menu.
4. If the Network Panel ID is changed and valid, the system will ask you to confirm the change. If it is not correct, you can change the DIP switches at this time.
5. Press up to select YES and press ENTER to confirm.

6.2.4 Computer Access

An installer at the panel site can initiate communications between the panel and a computer running the HFSS Honeywell Fire Software Suite (see also Section 10.1). In order for this communication to function properly, both the computer (running the software) and the control panel must have matching computer access numbers and computer codes.

To program computer access information:

1. Enter the installer code. The panel will automatically go to the main menu.
2. Select 6 for Network Programming.
3. Press 4 to enter the Computer Access menu.
4. Enter the computer access number (up to 6-digits, default 123456), then press ENTER.
5. Enter the computer code, then press ENTER.

6.2.5 Access Codes

Access codes provide the user access to the control panel functions. Each access code can be customized for each user. This allows some users the ability to access programming and other higher level panel functions, while

other users may only need access to lower level functions such as performing fire drills, or acknowledging trouble conditions.

Profile 1 is the profile that dictates what functions the Fire Fighter Key has access to. Because this is the profile for a key, the user name and the access code can not be edited for this profile.

Profile 2 is the profile for the installer and is referred to as the “Installer Code”. This profile’s user name and panel functions can not be edited. Table 7-9 lists the panel functions that can be selected for each user profile.

Table 6-1: User Profile Selectable Panel Functions

Type of Function	Selectable Functions
Panel Operations	System Reset
	System Silence
	System Ack
	Fire Drill Key
	*F1 Function Key
	*F2 Function Key
	*F3 Function Key
	*F4 Function Key
	EVS Control Request Function
	EVS Super User Function
Panel Menus	System Tests
	Fire Drill Menu
	Indicator Test
	Walk Test-No Report
	Walk Test -With Report
	Communicator Test
	Clear History Buffer
	Point Functions
	Disable/Enable Point
	Point Status
	Set SLC Device Address
	SLC Single Device Locator
	SLC Multiple Device Locator
	I/O Point Control
	Event History
	Set Time & Date
	System Information
	Network Diagnostics
	Network Programming
	Panel Programming
Send/Receive Firmware Update	

*Function Keys are only available on the LCD annunciator

To change an access code:

1. Enter the installer code. The panel will automatically go to the main menu.
2. Select 6 for Network Programming Menu.
3. Select 5 for Access Codes.

Display reads: *Select Profile 01*
 Fire Fighter's Key

4. Select the access code you wish to edit by pressing the up or down arrow key.
5. Then press ENTER.

Profile Edit Menu

From the Profile Edit Menu you can change the users name, access code, and the panel functions that the user will have access to with their code.

Note: Profile 1 (Fire Fighter's Key) the user name and access code can not be edited. Profile 2 (Installer) the user name and panel functions can not be edited. Profile 3 (Multi-Site Installer) is defaulted with the Multi-Site access option, but the entire profile can be edited.

6.2.5.1 Edit Name

6. See Appendix B for a list of available characters and their numeric designators.
7. Then press ENTER to finish.

6.2.5.2 Edit Access Code

8. Enter new access code (minimum of 4 digits, maximum of 7 digit).
9. Press ENTER.
10. Enter code again. Press ENTER.

6.2.5.3 Panel Functions

11. Press the up or down arrow key to move through the list of available functions.
12. Then press right arrow to move to Y (yes) or N (no) selection column.
13. Press the up or down arrow key to select Y or N.
14. Press ENTER.
15. Repeat steps 12 through 15 until user profile is complete.

6.2.6 Communicator Options

Communicator options provides the configuration for reporting events to a central station.

1. From the main menu.
2. Select 6 for Network Programming.
3. Press 6 to enter Communicator Options menu.

6.2.6.1 Communicator Assignments

Each panel on the 6820/EVS communication link system specifies which communicator is used for reporting. The communication link capability of the linked system allows all panels to use the same communicator providing an economical solution for reducing the number of paths required for reporting purposes. A communicator is specified by panel number. The communication link will be used to report events according to the communicator report table.

6.2.6.2 Communicator Miscellaneous

When using the SIA reporting format, the communicator sends information according to the SIA Reporting Type. The selections for this option are:

1. pi modifier (default)
2. Panel ID*

*Note: *Only SIA sends the panel ID when reporting.*

6.2.6.3 Receiver Configuration

The 6820/EVS system can report events to as many as 68 receivers. See Appendix C for panel/receiver relationship numbers. Each receiver is assigned a phone number and reporting format. Phone numbers can be up to forty digits long.

1. From the main menu.
2. Select 6 for Network Programming.
3. Press 6 to enter Communicator Options menu.
4. Select 3 for Receiver Configuration.
5. Select Panel to Program and press ENTER.
6. Enter the receiver number that you want to report to. The receiver numbers available will correspond with what panel number you entered. Receiver numbers are populated based on panel number and audited to allow only the 4 appropriate receivers. See Appendix D for receiver number

Available Format choices are:

Reporting Format
Contact ID
SIA500
Ethernet
Cellular
eVance
UNUSED
SIA8
SIA20

6.2.6.4 Communicator Reporting Table

The Communicator Report Table specifies event reporting for each panel on the communication link. Each row in the table specifies a panel, event types to report, primary and backup receiver numbers, and report by point or zone. Associated with the receivers are account number and daily test option. The table can have up to 99 rows.

1. From the main menu.
2. Select 6 for Network Programming.
3. Press 6 to enter Communicator Options menu.
4. Select 4 for Communicator Reporting Table.

- Press * to add rows, Press ENTER to edit data

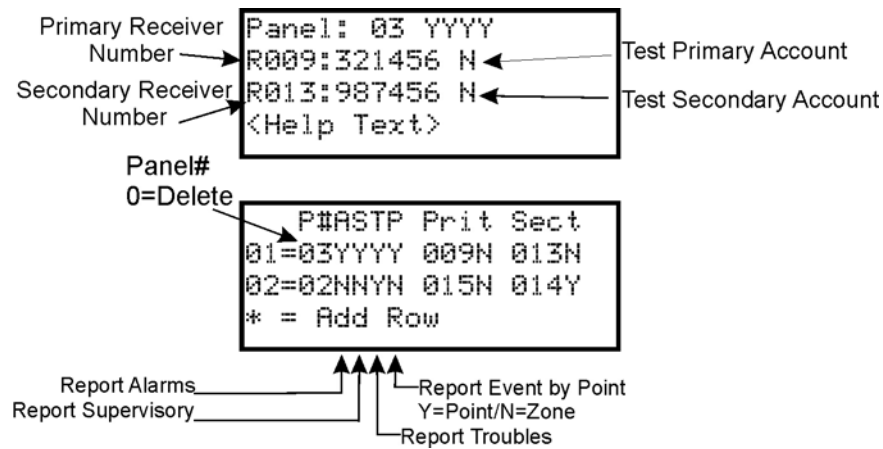

Figure 6-1 Communicator Reporting (4x20 screen)

6.3 Voice Options

6.3.1 Edit Timers

- Enter the installer code. The panel will automatically go to the main menu.
- Select 6 for Network Programming.
- Select 7 for Voice Options.
- Choose Site.
- Select 1 for Edit Timers

6.3.1.1 Control Lockout

The Control Lockout countdown timer is set to the programmed value when an LOC gains EVS Control. The timer starts over upon any key press at the EVS Control LOC. While the Control Lockout timer is active, an LOC of equal priority must request EVS control. The Control Lockout timer is cleared when EVS Control is relinquished. The Control Lockout timer does not apply to EVS Super User control.

Select Immediate/Timer/Never

Range 0-720 min/0-59 sec

6.3.1.2 Auto Reset EVS MIC Triggered Event

If the Timer is selected, the event will automatically reset after being active for the programmed time. If Event Disabled is selected, the event will not be allowed to be activate from an LOC Station. Selecting Never will require an emergency system reset to be performed to reset the event.

Select Never/Timer/Event Disabled, Range from 1-240 min

Table 6-2 Auto Reset EVS MIC Triggered Event Timer Menu

EVS Timer	Option
Control Lockout	Immediate/Timer/Never
Auto Reset EVS MIC Triggered Event	Never/Timer/Event Disabled
Auto Reset EVS Event 1	Never/Timer/Event Disabled
Auto Reset EVS Event 2	Never/Timer/Event Disabled
Auto Reset EVS Event 3	Never/Timer/Event Disabled
Auto Reset EVS Event 4	Never/Timer/Event Disabled
Auto Reset EVS Event 5	Never/Timer/Event Disabled
Auto Reset EVS Event 6	Never/Timer/Event Disabled
Auto Reset EVS Event 7	Never/Timer/Event Disabled
Auto Reset EVS Event 8	Never/Timer/Event Disabled

6.3.2 Edit Voice Commands

When a voice output group is selected to be activated by a zone, the cadence pattern choice does not apply. For voice output groups, one of six system wide voice commands will activate instead of the cadence pattern.

1. Enter the installer code. The panel will automatically go to the main menu.
2. Select 6 for Network Programming Menu.
3. Select 7 for Voice Options.
4. Choose Site.
5. Select 2 for Edit Voice Commands.
6. Select the command you wish to edit:

Table 6-3 Voice Command Mapping

System Event
Fire Alarm
Fire System Aux 1
Fire System Aux 2
Fire Zone Aux 1
Fire Zone Aux 2
Fire Pre Alarm
Emergency Communication 1
Emergency Communication 2
Emergency Communication 3
Emergency Communication 4
Emergency Communication 5
Emergency Communication 6
Emergency Communication 7
Emergency Communication 8
Fire Supervisory
System Alert 1-5
Trouble
Fire Interlock Release
Fire Interlock Alert
Custom Emergency Comm
Emergency Supervisory
CO Alarm
CO Supervisory

7. Select whether a Message or Tone Only should be played. If Message is selected, choose the desired message for the command.
8. Select the tone to be played between messages. (High-Lo, ANSI Whoop, Cont. Whoop, ANSI, March Code, California, Steady, Alert Tone, or No Tones).

Note: 520Hz tones are available when using EVS-VCM, EVS-INT50W or EVS-100W AMP's. These include ANSI 520, Temp 4 520, Steady 520. See Table A-6 for a list of compatible speakers.

9. Select how many times you wish the message to repeat. (None, 1 - 14, or Continuous).
10. Select the initial delay time (0, 3, 4, 8, 12, 16, 20, 24, 28).
11. Select the inter message delay time (4 to 32 seconds, in 4 second increments).
12. Select Y or N to allow message to continue to play after Mic release.
13. Select Y or N to allow message to restart on a new activation.

6.4 Sync Network Options

If after making changes to network programming, the distribution of network options fail, the system will report a trouble of network options out of sync. Use this menu to redistribute changed options to the rest of the network. The user will be required to choose a panel to source the options from. Scroll down through the informational message and press ENTER to view the Select Source screen.

1. Enter the installer code. The panel will automatically go to the main menu.
2. Select 6 for Network Programming Menu.
3. Select 8 for Sync Network Options.
4. Select which panel to source the options from.

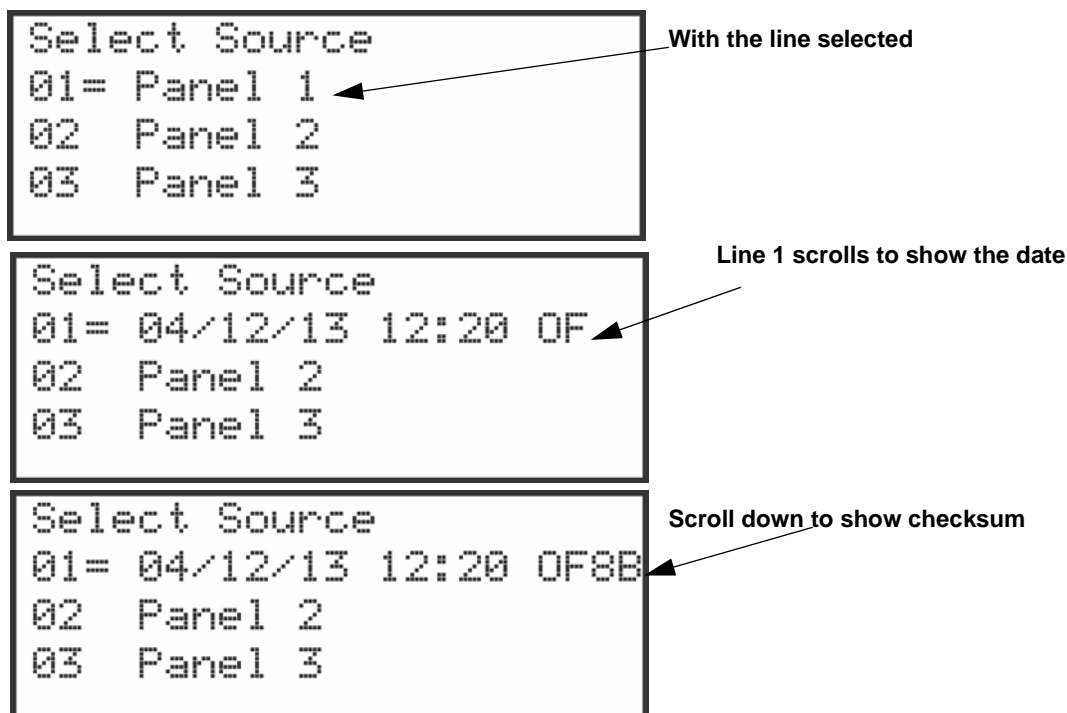

Figure 6-2 Sync Network Options on a 6820 - 4 x 20 screen

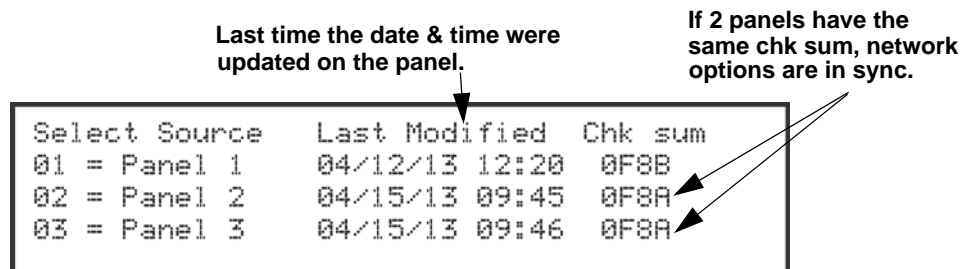

Figure 6-3 Sync Network Options on a 6820EVS - 4 x 40 screen

Network Management Quick Reference

	Menu	Options/Defaults			Comments	
Network Programing	Learn Network	Guest or member	Add or remove panels into the network		See Section 6.2.1	
	Edit Network Names	Panel Names	Network Panel ID	Edit Panel Names	See Section 6.2.2	
		Site Names	Edit Site Member	Edit Site Names		
	Edit Panel ID	Change current panel ID			See Section 6.2.3	
	Computer Access	Computer Access Number	*123456		See Section 6.2.4	
		Computer Code	*0			
	Access Codes	Select Profile (01 - 20)	Panel Functions	Edit Name		Profile 1 is the profile that dictates what functions the Firefighter Key has access to. Because this is the profile for a keys, the user name and the access code can not be edited for this profile.
				Edit Access Code		
				System Reset		
				System Silence		
				System ACK		
				Fire Drill Key		
				System Tests		
				Fire Drill Menu		
				Indicator Test		
				Walk Test-No Report		
				Walk Test-With Report		
Communicator Test					Profile 2 is the profile for the installer and is referred to as the "Installer Code". This profile's user name and panel functions can not be edited. See Section 6.2.5.	
Clear History Buffer						
Point Functions						
Disable/Enable Buffer						
Point Status						
Set SLC Device Address						
SLC Single Device Locator						
SLC Multi-Device Locator						
I/O Point Control						
Event History						
Set Time & Date						
Network Diagnostics						

	Menu	Options/Defaults			Comments	
Network Programming (cont.)	Access Codes	Select Profile (01 - 20)	Panel Functions	Network Programming	Profile 1 is the profile that dictates what functions the Firefighter Key has access to. Because this is the profile for a keys, the user name and the access code can not be edited for this profile. Profile 2 is the profile for the installer and is referred to as the "Installer Code". This profile's user name and panel functions can not be edited. See Section 6.2.5.	
				Panel Programming		
				System Information		
				Multi-Site		
				Upload/Download		
				F1 Function Key		
				F2 Function Key		
				F3 Function Key		
				F4 Function Key		
				EVS Control Request Function		
				EVS Super User Function		
				Send/Receive Firmware Update		
	Communicator Options	Communicator Assignments	Select Panel	Primary	0= unused	See Section 6.2.6
					Communicator Miscellaneous	SIA Options
		Include Panel ID in SIA Reporting				
		Receiver Configuration	Select Panel	Select Receiver	Receiver Number	See Section 6.2.6.3
					Receiver Format	
			SIA500			
			SIA8			
			SIA20			
eVance						
Ethernet						
Cellular						
UNUSED						
Receiver Credentials						
Communicator Report Table				Panel	See Section 6.2.6.4	
				Report Alarms		
				Report Supervisory		
				Report Troubles		
				Report Events by Point		
	Primary Receiver					
	Primary Account					
	Test Primary Account					
	Secondary Receiver					
	Secondary Account					
Test Secondary Account						

	Menu	Options/Defaults		Comments		
Network Programming (cont.)	Voice Options	Choose Site	Edit Timers	Control Lockout	Immediate/Timer/Never	See Section 6.3.1
				Auto Reset EVS Event 1-8	Never/Timer/Event Disabled	
				Auto Reset EVS MIC Triggered Event		
			Edit Voice Commands	Fire Alarm	See Section 6.3.2	
				Fire System Aux 1		
				Fire System Aux 2		
				Fire Zone Aux 1		
				Fire Zone Aux 2		
				Fire Interlock Release		
				Fire Supervisory		
				Fire Interlock Alert		
				Fire Pre Alarm		
				Custom Emergency Comm		
				Emergency Communication 1-8		
				Emergency Supervisory		
	System Alert 1-5					
	CO Alarm					
CO Supervisory						
Trouble						
Sync Network Options				See Section 6.4		

Section 7

SK, SD and SWIFT™ Wireless SLC Device Installation

Caution!

To avoid the risk of electrical shock and damage to the unit, power should be OFF at the control panel while installing or servicing.

7.1 List of SK SLC Devices

The following SK and wireless SLC devices can be used with the control panel. SK detectors include a 6" base. See the appropriate section number in this manual or the device installation instructions (packaged with the device) for more information.

Note: The control panel supports the use of either SK SLC devices or SD SLC devices. You cannot install both SLC device types on the control panel.

Table 7-1: SK SLC Devices

SK Part Number	Model Name/Description	Installation Instruction PN
SK-Photo	Photoelectric smoke detector	I56-3426-001
SK-Photo-T	Photoelectric smoke detector with thermal (135°F)	
SK-PhotoR	Photoelectric detector with remote test capability	
SK-Acclimate	Multi criteria photoelectric smoke detector with thermal (135°F)	
SK-Beam	Reflected beam smoke detector without test feature	I56-3433-001
SK-Beam-T	Reflected beam smoke detector with test feature	
SK-Duct	Photoelectric duct smoke detector with extended air speed range	I56-3432-000
SK-Heat	Fixed temperature thermal detector (135°F)	I56-3429-000
SK-Heat-ROR	Rate-of-rise thermal detector with 135° fixed temperature	
SK-Heat-HT	Fixed high temperature thermal detector (190°F)	
SK-Pull-SA	Addressable single action pull station	I56-3446-000
SK-Pull-DA	Addressable dual action pull station	I56-3447-000
SK-ISO	Fault isolator module	I56-3445-000
SK-Monitor	Monitor module	I56-3442-000
SK-Minimon	Mini monitor module	I56-3444-000
SK-Monitor-2	Dual input monitor module	I56-3435-000
SK-Mon-10	10 input monitor module	I56-3443-000
SK-Relay	Addressable relay module	I56-3438-000
SK-Relay-6	Six relay control module	I56-3439-000
SK-Relaymon-2	Dual relay/monitor module	I56-3735-000
SK-Zone	Addressable zone interface module	I56-3440-000
SK-Zone-6	Six zone interface module	I56-3441-000
SK-Control	Supervised control module	I56-3436-000
SK-Control-6	Six circuit supervised control module	I56-3437-000
SK-Fire-CO	CO Smoke Detector	I56-3945-000

Table 7-1: SK SLC Devices

SK Part Number	Model Name/Description	Installation Instruction PN
B200S	Sounder Base	I56-3387-00
B201LP	6" mounting base	I56-0595-00
B224BI	6" isolator base	I56-0725-00
B224RB	6" relay base	I56-3737-00
B200SR	Sounder base	I56-3392-00
B501	4" mounting base	I56-0357-00
B200SR-LF	Low Frequency Sounder Base	I56-4152-00
B200S-LF	Low Frequency Sounder Base	I56-4151-00

7.2 List of SD SLC Devices

The following SD SLC devices can be used with the control panel. SD detector bases are sold separately. See the appropriate section number in this manual or the device installation instructions (packaged with the device) for more information.

Note: The control panel supports the use of either SD SLC devices or SK SLC devices. You cannot install both SLC device types on this control panel.

Table 7-2: SD SLC Devices

SD Model Number	Model Name/Description	Installation Instruction PN
SD505-PHOTO	Photoelectric smoke detector.	150955
SD505-HEAT	Absolute temperature heat detector. Trip point range from 135°F–150°F (0°C–37°C).	
SD505-6AB	6" base	
SD505-6IB	6" short circuit isolator base	I56-3541-00
SD505-6RB	6" relay base	I56-3542-00
SD505-6SB	6" sounder base	I56-3540-00
SD505-DUCT	Duct Smoke Detector. Duct Housing including the SD505- Analog Photoelectric Smoke Sensor. Intake tubing for duct available in three lengths: SD505-T2 (2.5 foot); SD505-T5 (5 foot); SD505-T10 (10 foot)	1700-09882
SD505-DUCTR	Duct Detector housing with relay base. Duct housing with relay base including SD505- Analog Photoelectric Smoke detector pre-installed	1700-09882
SD500-PS/PSDA	Single or dual action addressable pull station	I56-3632-00
SD500-AIM	Addressable input module (switch input), standard size, DIP switch configurable	I56-3547-00
SD500-MIM	Mini input monitor module (switch input), small size, DIP switch configurable.	
SD500-ANM	Addressable notification module	I56-3544-00
SD500-ARM	Addressable relay module DIP switch configurable.	I56-3545-00
SD500-SDM	Addressable smoke detector module.	I56-3546-00
SD500-LIM	Line isolator module. Fits in a double gang box.	I56-3543-00
SD505-DTS-K	Remote test switch & LED indicator for the SD505-DUCTR	1700-09882

7.3 SWIFT Wireless SLC Devices

The WSK-WGI Wireless Gateway acts as a bridge between a group of wireless fire devices and a SLC loop on the 6820 /6820EVS. It is powered by the SLC loop or by a regulated, external 24VDC UL-listed power supply.

Available wireless devices include a photo detector, a photo/heat detector, a fixed-temperature heat detector, a rate-of-rise detector, and a monitor module. For details about wireless devices, system setup and operation see the SWIFT® Smart Wireless Integrated Fire Technology Manual # LS10036-001SK-E for more information.

7.4 Maximum Number of Devices

The 6820/6820EVS supports SK, SD or SWIFT™ SLC devices. The maximum number of SLC devices per system varies depending on device protocol. The number of SLC expanders is limited only by the SBUS bandwidth, point count, and 1A SBUS current limit. Device support is as follows:

- SK Devices–The 6820/EVS supports a total of 1,110 SK points. The SLC points can be all sensors or all modules or any combination of modules and sensors. SK devices are supported on the 6815 or the internal SLC.
OR
- SD Devices–The 6820/6820EVS system can support a total of 635 SD devices, in any combination. SD devices are supported on the 5815XL or the internal SLC.
OR
- SK SWIFT Wireless Devices–A SWIFT Gateway system supports up to 50 devices: 1 SWIFT Gateway and up to 49 (in any combination) wireless detectors and monitor modules. Multiple Gateways can be used. See the SWIFT manual P/N LS10036-001SK-E for more information.

7.5 Wiring Requirements for SLC Devices

The following information applies to all SLC devices. Refer to the section that describes the type of device you are installing for details.

7.5.1 Wire Sizing on 5815XL for SD Devices

The wire can be untwisted, unshielded, solid or stranded as long as it meets the National Electric Code 760-51 requirements for power limited fire protective signaling cables. Wire distances are computed using copper wire.

Maximum wiring resistance is 50 ohms for SD devices.

Maximum loop length depends on the wire gauge. See Table 7-3 for SD devices.

Table 7-3: Maximum wiring distance for SD devices

Wire Gauge	Max. Distance for SD
22 AWG	1500 feet
18 AWG	3900 feet
16 AWG	6200 feet
14 AWG	10,000 feet

7.5.2 Wire Sizing for 6815

The SLC requires use of a specific wire type, depending on mode of operation, to ensure proper circuit functioning. Wire size should be no smaller than 18 AWG and no larger than 12 AWG wire. The wire size depends on the length of the SLC circuit. It is recommended that all wiring be twisted-pair to minimize the effects of electrical interference.

7.5.3 SK Modules

The 6820 or 6820EVS SLC can be programmed to operate in SK mode. While shielded wire is not required, it is recommended that all SLC wiring be twisted-pair to minimize the effects of electrical interference. Use Table 7-4 to determine the specific wiring requirements for the SLC.

Table 7-4 SLC Wiring Requirements for SK modules

Wire Requirements	Distance in Feet (meters)	Wire Type
RECOMMENDED: Twisted-unshielded pair, 12 to 18 AWG (3.31mm to 0.82 MM). 50 ohms, maximum per length of Style 6 & 7. 50 ohms per branch maximum for Style 4 loop.	12,500 ft. (3,810 m)	12 AWG (3.31 mm)
	9,500 ft. (2895.6 m)	14 AWG (2.08 mm)
	6,000 ft. (1,828.8 m)	16 AWG (1.31 mm)
	3,700 ft. (1,127.76 m)	18 AWG (0.82 mm)
Untwisted, unshielded wire, in conduit or outside of conduit.	5,000 ft. (1,528 m)	12 to 16 AWG (3.31 mm to 1.31 mm)
	3,700 ft. (1,127.76 m)	18 AWG (0.82 mm)
Twisted, shielded pair Note: • Shields must be isolated from ground • Shields should be broken at each device	5,000 ft. (1524 m)	12 to 16 AWG (3.31 mm to 1.31 mm)
	3,700 ft. (1,127.76 m)	18 AWG (0.82 mm)
Note: Maximum total capacitance of all SLC wiring (both between conductors and from any conductor to ground) should not exceed 0.5 micro farads.		

Figure 7-1 and Figure 7-2 show how wire length is determined for out & back tap and T-Tap.

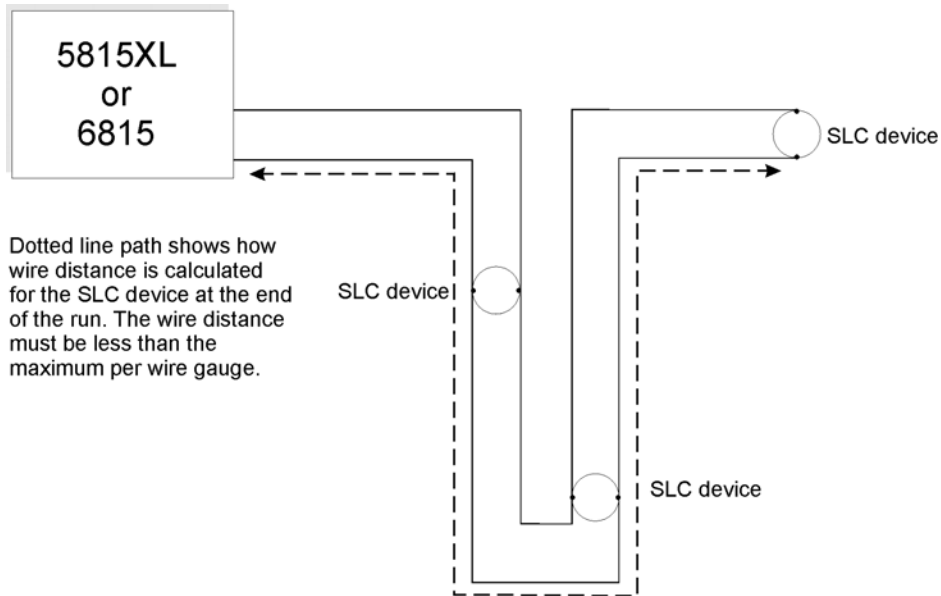

Figure 7-1 Calculating wire run length for a simple out and back

When using T-taps, the total length of all taps and the main bus must not exceed 40,000 feet. This requirement must be met in addition to the maximum distance requirements for the various wire gauges.

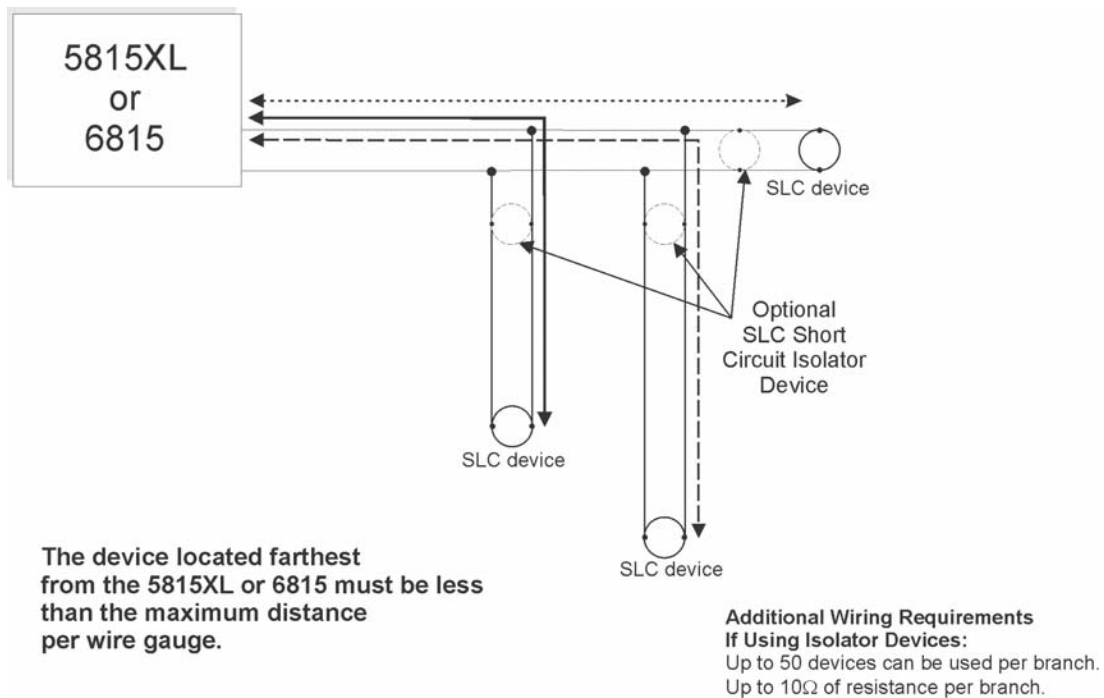

Figure 7-2 Calculating Wire Run Length for a T-Tap

7.5.4 Wiring 5815XL or 6815 in Class A Configuration

Figure 7-3 illustrates how to wire the SLC loop for Class A installations.

Note: Class A wiring also requires an isolator module as the first device on the in and the out loops.

Note: No t-taps allowed on class A SLC loops.

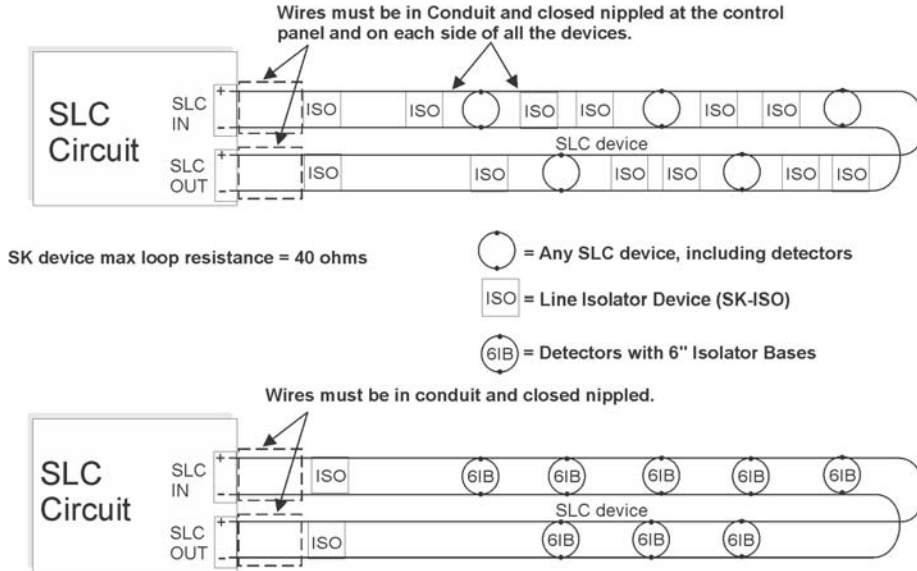

Figure 7-3 Class A SLC Configuration

7.6 Wiring SK SLC Detectors

This section describes how to install SK heat and smoke detectors. See Table 7-1 for a list of detectors. Refer to the detectors' installation instructions for more detailed information.

To wire SK detectors:

1. Wire device bases as shown in Figure 7-4.
2. Set the address for each device as described in Section 7.7

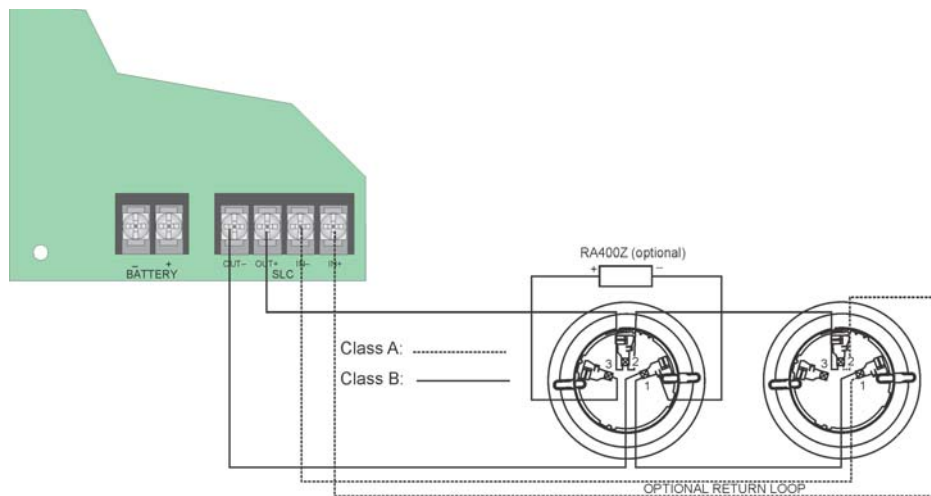

Figure 7-4 Heat and Smoke Detector Connection to the Panel.

7.7 Addressing SK SLC Devices

All SK devices are addressed using the two rotary dials that appear on the device board. Use the *ONES* rotary dial to set the ones place in a one or two digit number, and use the *TENS* rotary dial to set the tens place in a two or three digit number.

The control panel recognizes when an SK detector or SK module is installed. For this reason, SK detectors can be assigned any unique address from 1 to 159, and SK modules can be assigned any unique address from 1 to 159. There can be an SK detector using address 1 and an SK module using address 1.

0 is an invalid address. In order to set the sensor above address 99, carefully remove the stop on the upper rotary switch with thumb as shown in Example 2.

Example 1: To select device address 35, turn the *ONES* rotary dial to **5** and the *TENS* rotary dial to **3** as shown in Figure 7-5.

Example 2: To select device address 105, turn the *ONES* rotary dial to **5** and the *TENS* rotary dial to **10** as show in Figure 7-5.

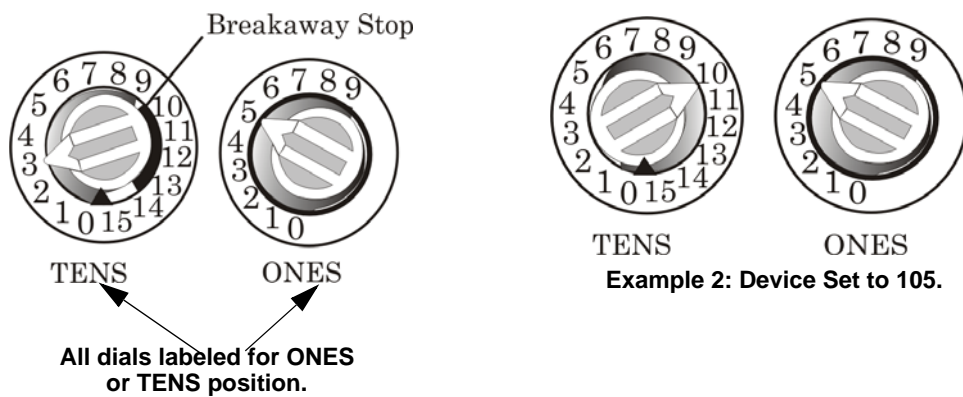

Figure 7-5 SK SLC Device Addressing Using Rotary Dials

7.8 Wiring SD SLC Detectors

The information in this section applies to the following SD models, see Table 7-2 for list of devices.

To Wire SD Detectors:

1. Wire device bases as shown in Figure 7-6.

- Set the address for each device as described in Section 7.9.

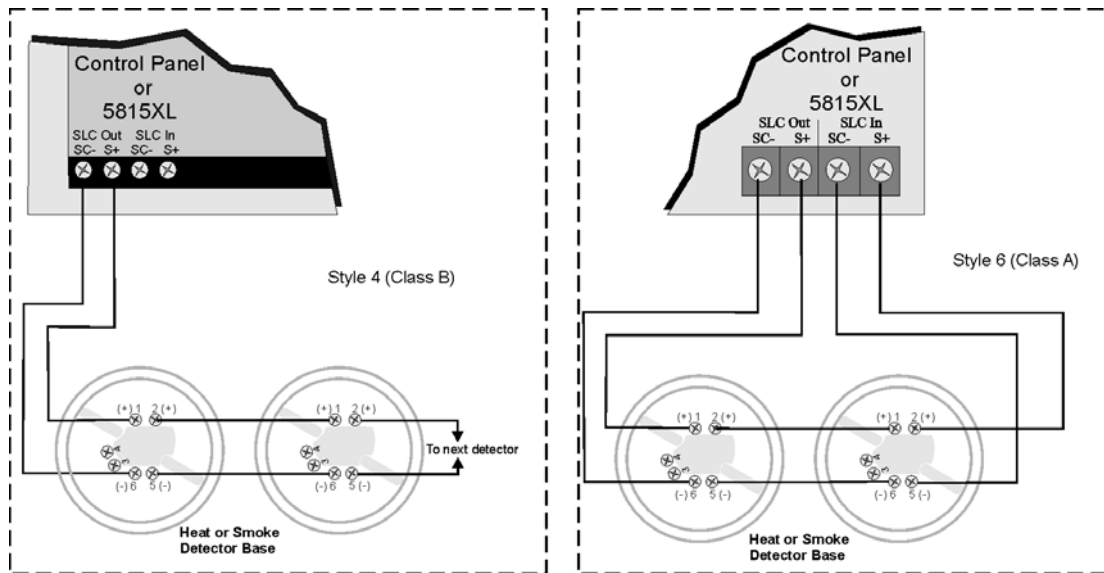

Figure 7-6 Heat or Smoke Detector Connection to the FACP

7.9 Addressing SD SLC Devices

This section tells how to address detectors and modules. See Table 7-2 for a list of detectors that are easily addressed at the FACP. The Installer Code is required to perform this task.

To address:

- Connect a detector base temporarily to the programming terminals as shown in Figure 7-7. (You can use the same base for each detector.)

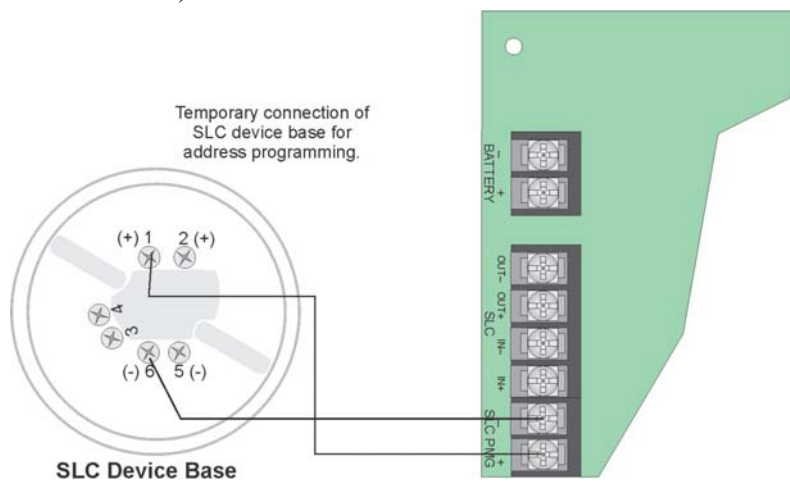

Figure 7-7: Temporary Connection of Detector Base to Panel for Addressing

- Enter the Installer code. The panel will automatically go to the main menu.
- Select 2 for Point Functions.
- Select 3 for Set SLC Device Address.
- Select “Yes” by pressing the up arrow, then press ENTER. (The panel will go into trouble at this point. You can use the SILENCE key to stop the PZT. The trouble will clear automatically when the panel re-boots when you finish programming.)

6. When the wait message clears, the following options display:
 - 1- for Read Address. Use to read (or check) a single detector's address.
 - 2- for Write Address. Use to program a single detector's address.
 - 3- for Seq. Programming. Use to program more than one detector in sequential order.
7. If you are changing addresses, write the programmed address on the back of the device.
8. To exit press left arrow until fully exited.

7.9.1 SLC Devices with DIP Switches

Input and relay module addresses are set using the DIP switches on the module board. The chart below shows the available addresses. For example, to select address 3, place DIP switches 1 and 2 in the up position. The range of valid addresses is 1-127. 0 is an invalid address.

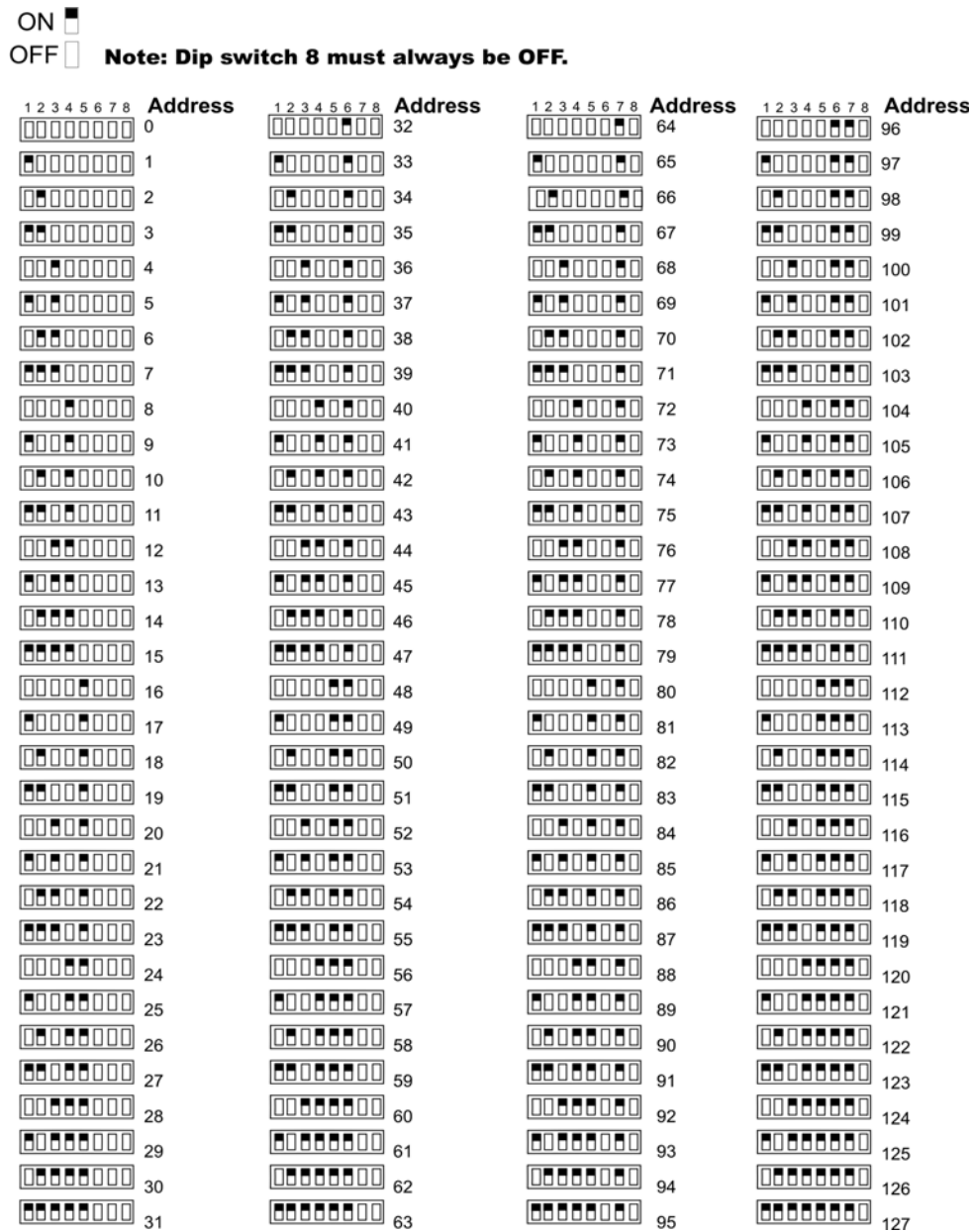

Figure 7-8 SD SLC Device Addressing Using DIP Switches

7.10 SK-WGI Wireless Gateway

Note: The SK-WGI, as part of the wireless network, has been tested for compliance with the Federal Communications Commission (FCC) requirements of the United States Government. It has not been evaluated for use outside the USA. Use of this system outside the USA is subject to local laws and rules to which this product may not conform. It is the sole responsibility of the user to determine if this product may be legally used outside the USA.

Note: It is recommended to use the same wire gauge if there are multiple connections to the same terminal.

For more information regarding Gateway wiring instructions, see SWIFT manual LS10036-000SK-E.

7.10.1 Power Connections for the Gateway

The SK-WGI Wireless Gateway acts as a bridge between a group of wireless fire devices and a SLC loop on the 6820/EVS. It is powered by the SLC loops or by a regulated, external 24 VDC UL listed power supply. For details about wireless devices, system setup, and operation, see the SWIFT™ *Smart Wireless Integrated Fire Technology Instruction Manual P/N LS10036-000SK-E*.

Section 8

Programming Overview

This section of the manual is intended to give you an overview of the programming process. Please read this section of the manual carefully, especially if you are programming the control panel for the first time.

The JumpStart[®] AutoProgramming feature automates many programming tasks and selects default options for the system. You should run JumpStart[®] at least once when you are installing the system. See Section 8.1 for details. After you run JumpStart, you may need to do some additional programming depending on your installation. Section 9 of this manual covers manual programmable options in detail.

Programming the panel can be thought of as a three part process. You must program:

- System options. These are options that affect general operation of the panel (see Section 9.6 for details).
- Options for input points and zones. These are primarily options that control the detection behavior of devices (see Section 9.5 for details).
- Options for output points and groups. This includes selecting characteristics for output groups and mapping output circuits to output groups (see Section 9.4 for details).

8.1 JumpStart[®] Autoprogramming

The JumpStart[®] AutoProgramming feature allows for faster system setup. When you run JumpStart[®] AutoProgramming, the panel searches for expanders and SLC devices not currently in the system. The new devices are added in their default configuration. At the end of the JumpStart you can choose to not accept the new devices and go back to the configuration you had before. JumpStart saves the installer from having to program options for each device. Depending on the application, the installer may need to make some changes after JumpStart[®] completes.

See Section 8.1.3 for complete details about running JumpStart AutoProgramming.

8.1.1 Input Points

The first JumpStart[®] on the panel in default configuration will determine the number and type of input points (detectors or contact monitor modules) on each SLC loop. JumpStart AutoProgramming assigns the correct detector type (heat, ionization or photoelectric), so the installer does not need to edit the device type for detectors. Any contact monitor modules on the system will be assigned type “Manual Pull.” The installer will need to manually change the switch type if manual pull is not correct.

The first JumpStart[®] AutoProgramming creates one zone (Zone 1) and assigns all input points to Zone 1. Zone 1 is mapped to Output Group 1.

8.1.2 Output Points

The 6820 JumpStart[®] creates three output groups. The 6820/EVS with amplifiers will create four output groups. The output circuits are assigned as follows:

Circuits 1-6:

Configured as Notification and assigned to Group 1. JumpStart[®] AutoProgramming automatically programs Zone 1 to activate Group 1 using constant on output when an alarm condition occurs.

Circuit 7 (Relay 1):

Assigned to Group 998. JumpStart[®] automatically programs Zone 1 to activate Group 998 using constant on output when a supervisory condition occurs.

Circuit 8 (Relay 2):

Assigned to Group 999. JumpStart® automatically programs Zone 1 to activate Group 999 using constant on output when an alarm occurs.

Amplifier Circuits:

Assigned to Group 2. JumpStart® automatically programs Zone 1 to activate Group 2.

Addressable output points (Relay modules):

All addressable relay devices will be configured as “Output Pt” (general purpose output point) and assigned to Group 1.

Note: Relay output is constant even if the zone activating the relay is programmed with an output pattern.

8.1.3 Running JumpStart® AutoProgramming

Run JumpStart® AutoProgramming immediately after you have addressed and connected all input devices (detectors, pull stations, and so on) and output devices (notification appliances, relays, and so on).

Note: If you need to install a few devices after you have run JumpStart®, you can install them manually or run JumpStart® again at a later time. JumpStart® will keep user options, such as names, for devices already installed. Follow instructions in Section 9 for configuration.

To run JumpStart, follow these steps:

1. Select 7 for Program Menu. Enter the Access Code
2. Select 6 for JumpStart® AutoProgramming.
3. The message “The system will be shut down during JumpStart®.” Press ENTER to accept.
4. When the message, “SLC FAMILY” message appears, select SK or SD; depending on the type of SLC devices the panel is using, and press ENTER to accept.
5. A series of messages displays for the next several seconds. JumpStart® scans the SLC loops for devices. This can take several minutes, depending on the number of devices attached.
6. When the message “Configuring System Done” displays, press any key to continue.
7. Select one of the following options from the menu that displays.

1 - Review System	Press 1 if you need to review the JumpStart® configuration.
2 - Repeat JumpStart	Press 2 if you need to rerun JumpStart® for any reason.
3 - Accept Configuration	<ol style="list-style-type: none"> 1. If you are ready to make the JumpStart® configuration permanent, select 3. 2. The system will ask you if the installation contains any addressable duct detectors. If there are none, select 2 for No and skip to Step 8. If the system contains duct detectors, select 1 for Yes and continue with Step 3. 3. From the list that displays, select the SLC that contains the duct detectors. 4. The first photoelectric or ionization detector on the system will display. Select 1 for DUCT and 2 for NonDUCT. 5. Press up arrow to select the next detector. Select 1 for DUCT and 2 for NonDUCT. Continue until all duct detectors have been selected. (Note: You can move backwards through the list with down arrow). 6. When you reach the last detector on this device, press left arrow. 7. The system will ask you if there are any duct detectors used. If there are, select 1 for Yes and the message will ask, Have All Addressable Duct Detectors Been Identified? Left arrow for “No”, Right arrow for “Yes”. If there are no more duct detectors, continue with Step 8. 8. The system will restart with the saved JumpStart® configuration. 9. After the system resets, it will use the new JumpStart® configuration.
4 - Discard Changes	If you want to discard the changes, and keep the configuration you had before running this JumpStart, press 4.

8.2 Mapping Overview

This section of the manual is a high level overview of mapping.

Mapping is an important concept with the control panel. In general terms, mapping is assigning or linking events to outputs that will activate when events occur. You do this by assigning input points to input zones, output points to output groups and then linking or mapping zones and output groups.

Figure 8-1 is a brief overview of the concept of mapping. The next several pages of the manual show these subjects in detail.

In its simplest application, mapping is determining which outputs are activated by which inputs.



Because the Control Panel programming is so flexible, there are a number of uses for mapping, as shown in the diagram below.

Input zones are mapped by event type to output groups. Cadence patterns are assigned as part of the mapping information. Up to 8 groups/patterns can be selected for each event.

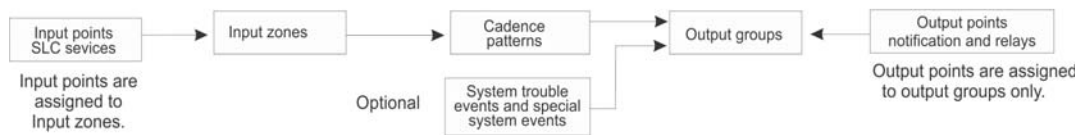

Figure 8-1 Mapping Overview

Note: Mapping cannot be programmed through annunciators and can only be programmed through HFSS Honeywell Fire Software Suite.

8.2.1 Input Point Mapping

Input points are assigned to input zones, as the example in Figure 8-2 shows. Any input point can be assigned to any input zone. (Input points can be assigned to one zone only. An input point can be designated as “Unused,” which means it has not been assigned to a zone).

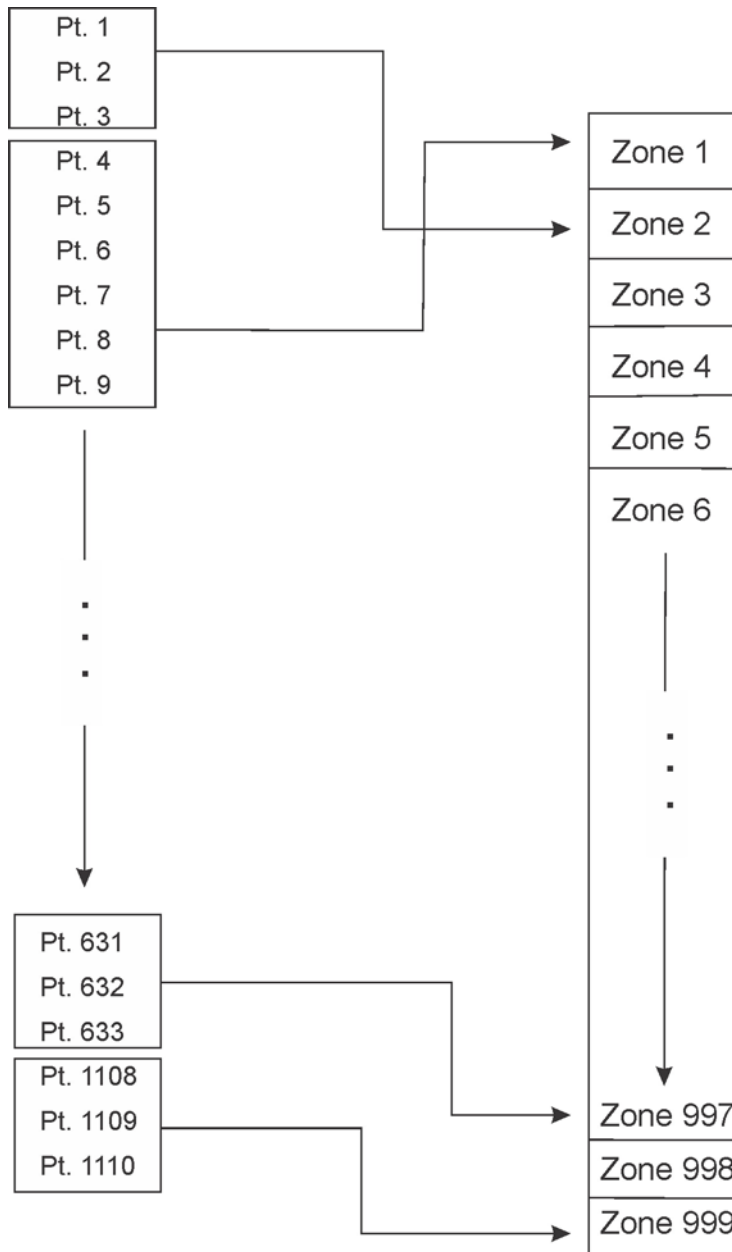

Figure 8-2 Input Point Assignment Example

8.2.2 Output Circuit Mapping

Figure 8-3 is a simple example showing how to assign notification and relay output circuits to groups. For an example of a simple floor above/floor below application, see Figure 8-5.

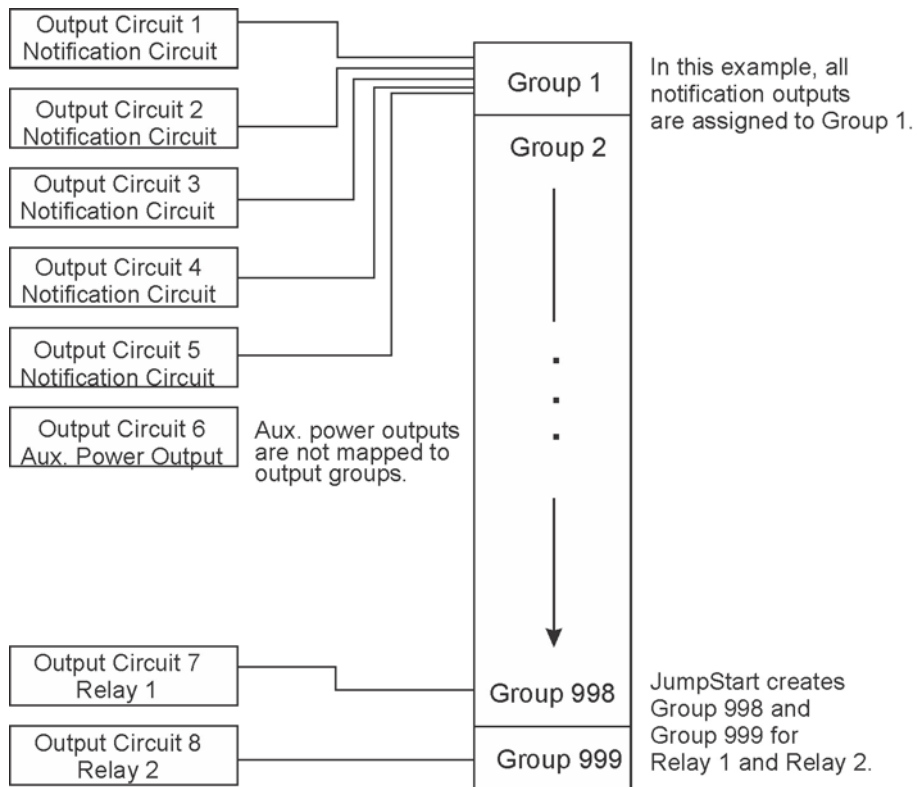

Figure 8-3 Example of Assigning Output Circuits to Groups

8.2.3 Event Mapping

There are 11 types of Zone events 14 types of Panel events, and 6 types of Site events that can be mapped (see Table 8-1). For each event type, you can activate output groups and patterns. Mapping examples are shown in Figure 8-4, Figure 8-5 & Figure 8-6.

Table 8-1: Event Types

System	Zone	Panel	Site
Fire	Manual Pull Alarm	System Aux 1 Alarm	Fire Drill
	Water Flow Alarm	System Aux 2 Alarm	General Fire Alarm
	Detector Alarm (heat or smoke detectors)		General Fire Supervisory
	Zone Aux 1 Alarm		General Fire Pre-Alarm
	Zone Aux 2 Alarm		
	Interlock Alert		
	Interlock Release		
	Pre-Alarm		
	Fire Supervisory		
	Status Point		
	CO Alarm		
	CO Supervisory		
Emergency			LOC EVS 1-8 Alarm
			General EVS Alarm
			General EVS Supervisory
			Point EVS 1-8 Alarm
Advisory	Trouble	SBUS Expander Trouble	General Trouble
	Status Point Active	SBUS Class A Trouble	Site Silenced
		SLC Loop Trouble	Voice Aux In 1-8 Alarm
		AC Loss Trouble	F1 Key Active
		Battery Trouble	F2 Key Active
		Ground Fault Trouble	F3 Key Active
		Phone Line Trouble	F4 Key Active
		Reporting Account Trouble	Voice Aux in 1-2
		Printer Trouble	System Mic Active
		Aux Power Trouble	Background Music
		System Switch Trouble	
	Output Group Trouble		

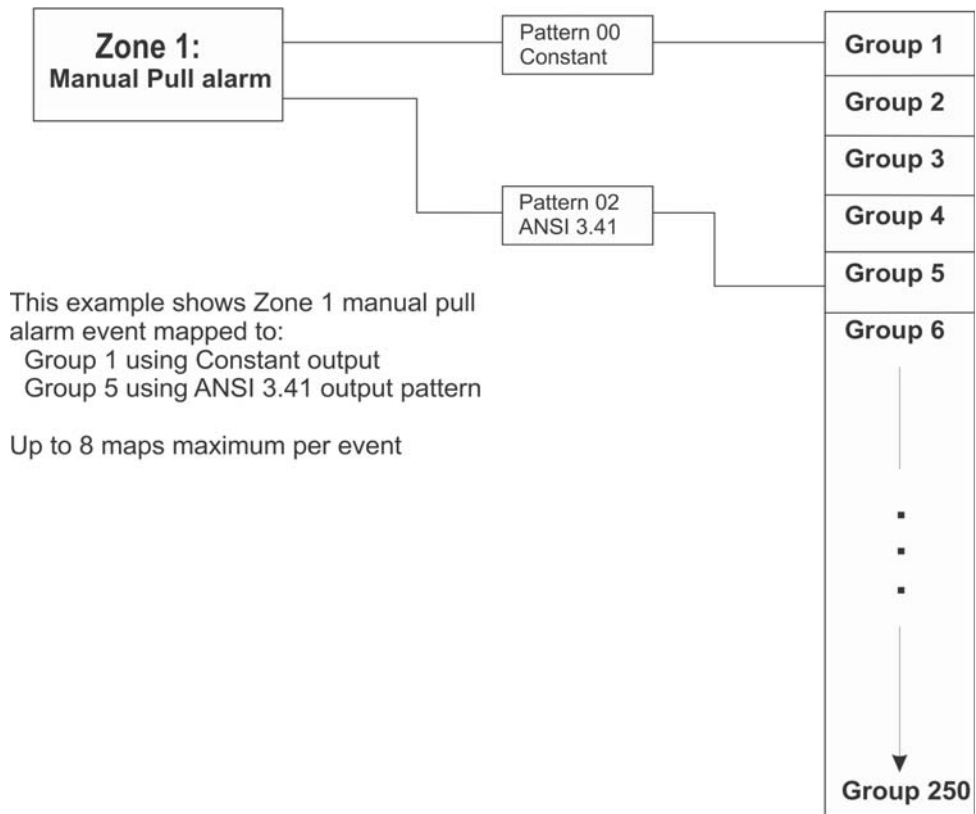

Figure 8-4 Example of Zone Events Mapped to Output Groups and Patterns

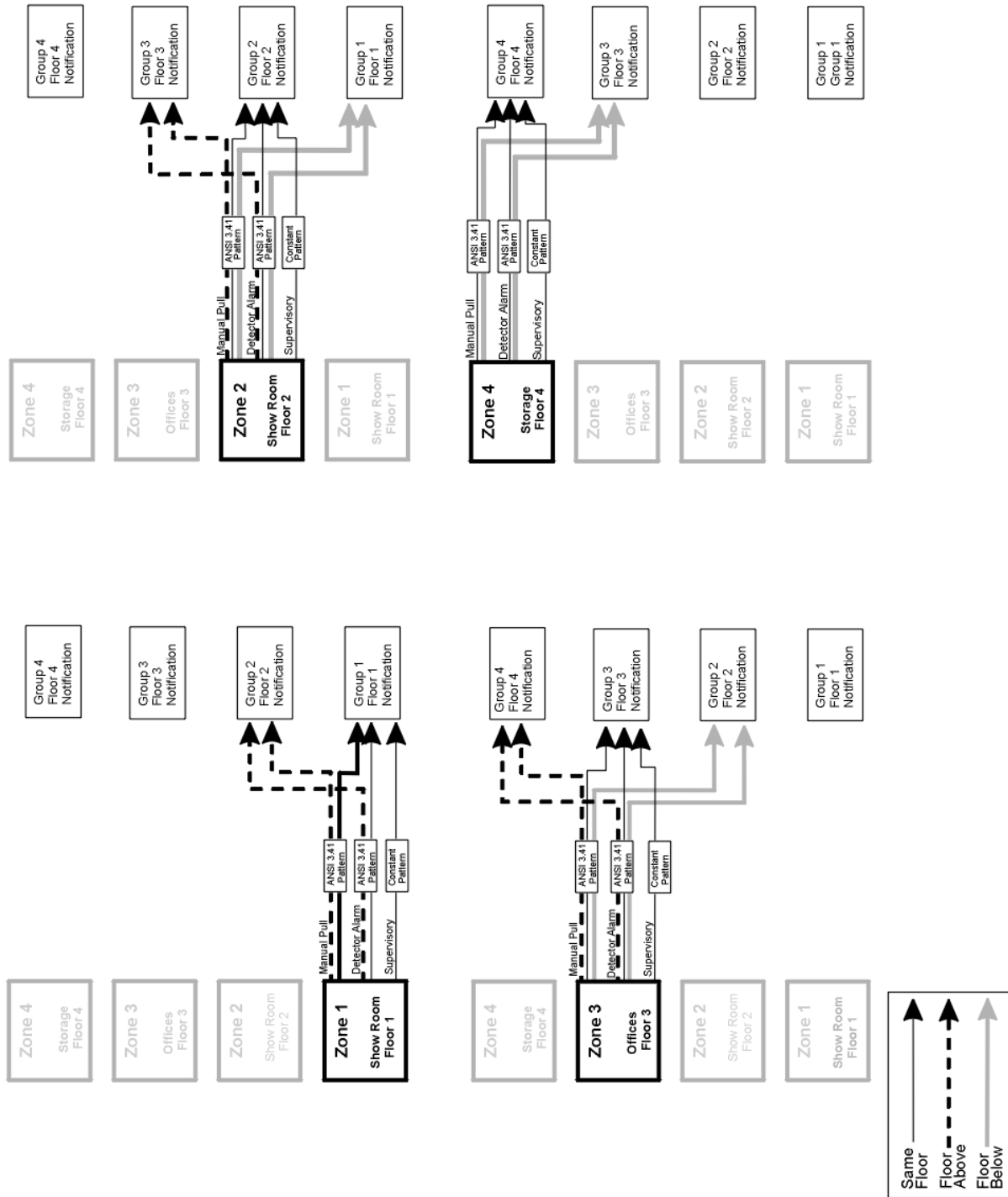

Figure 8-5 Example of Zone Events Mapped to Output Groups and Patterns

8.2.4 Mapping LED Points

Figure 8-6 is a simple example showing how LED points are mapped to zones and output groups. Typically you would create two output groups for each zone, one for alarms and one for troubles. (LED points are available when Models 5865-3/4 and/or 5880 are used with the system.)

Mapping LEDs to Zones and Output Groups

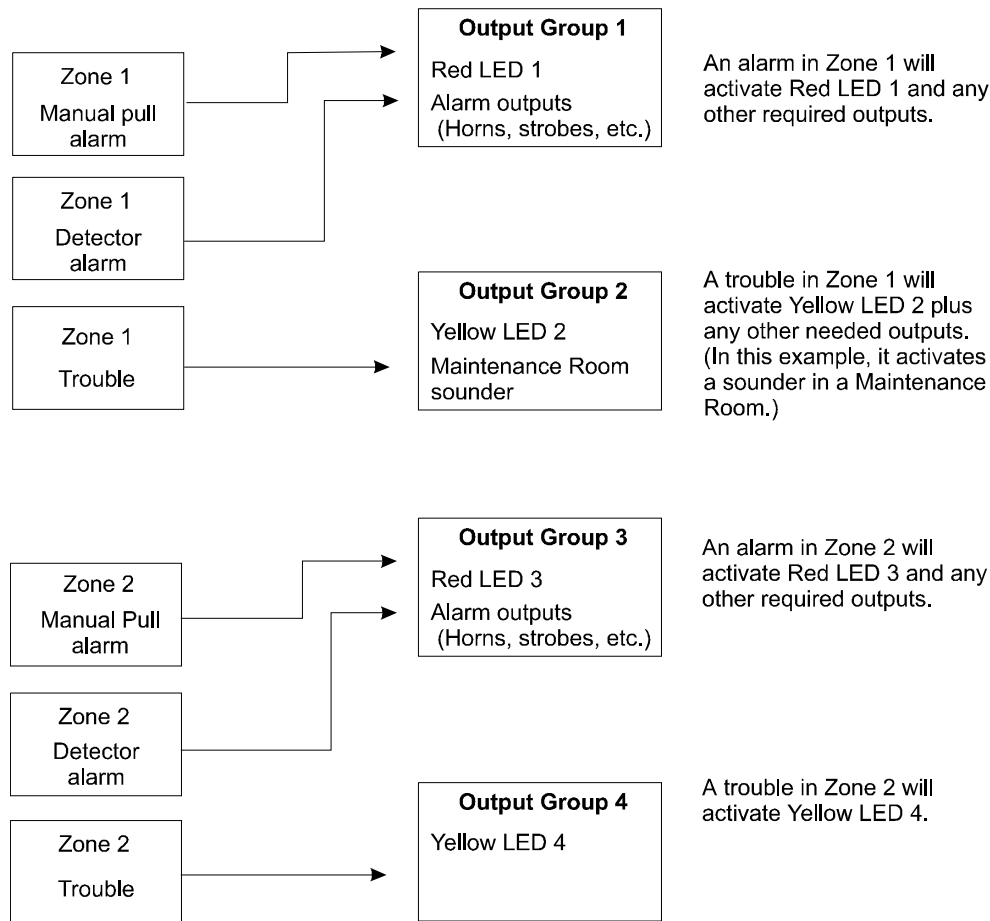

Figure 8-6 Example of LED Points Mapped to Output Groups (Applies to Models 5865-3/4 and 5880)

8.3 Programming Using the HFSS Software Suite

You can use the HFSS Honeywell Fire Software Suite to program the control panel onsite (personnel will need to be onsite during the upload or download process). HFSS is a software package that lets you easily program the control panel using a Windows-based computer. HFSS is needed for Mapping. When using HFSS, you can set up the programming options for the panel, save the options in a file, then download the file to the panel. You can connect to the control panel directly using the onboard USB or Ethernet. Updates are available at www.silentknight.com

8.4 Programming Using an Annunciator

You can program the control panel from a system annunciator, using either the control panel’s on-board

annunciator or a 5860, 6860 & 6855 remote annunciator.

Note: Mapping cannot be programmed through the on-board and remote annunciators. Mapping is only available through HFSS Honeywell Fire Software Suite up/downloading software.

The following subsections describe programming basics, including a description of editing keys available for programming and how to move through programming menus. Section 9 contains specific information about individual programming options.

8.4.1 Entering / Exiting the Program Menu

To enter Programming Menu:

1. Enter the Installer Code (factory programmed default code is 123456).
2. Then press 7. The menu option displays. See Section 9 for detailed menu information and Section 8.5 for a quick reference listing all programmable options and JumpStart defaults.

To exit Programming Menu:

When you have completed working with the menus, press left arrow several times until you are exited from programming mode. Two prompts will display. The first prompt is to make sure you intended to leave the Program Menu (select Yes or No as appropriate). The second prompt is for accepting all changes. If you select No, any changes you have made since you entered the Program Menu will have no effect.

8.4.1.1 Moving through the Menus

Figure 8-7 shows how to move through Program Menu screens, using the System Tests screen as an example.

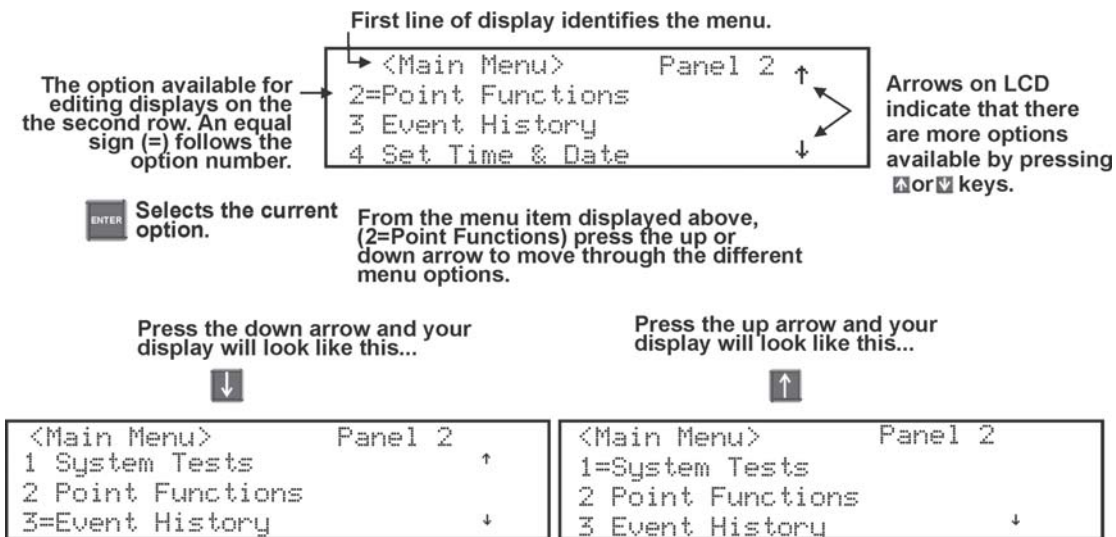

Figure 8-7 Moving through Program Menu

8.4.1.2 Selecting Options and Entering Data

There are several ways to make programming selections using the control panel depending on which screen you are currently viewing. The chart below is a generic explanation.

To	Press
Enter the number	The corresponding number on the annunciator.
Enter numeric data	The appropriate number on the annunciator.

To	Press
Enter text (alphanumeric data)	See Appendix B for complete list of characters.
Select from a scrolling list	The up or down arrow to move through the list of available options. When the option you want to select is displayed, press ENTER.

8.5 Programming Menu Quick Reference

This section of the manual lists all Program Menu options in the order they appear on the sub-menus. Default settings are indicated in text or marked with an asterisk (*). The comments column provide quick information and a reference to a section (if applicable) which has more detailed information.

Table 8-2: Programming Quick Reference Table

Menu		Options/Defaults		Comments			
Module	Edit Module	Select Module	Edit Module ID	Section 9.2.1			
			Enter Module Name				
			Edit Module specific options				
	Add Module	5824-Serial/Parallel / IO 6860 LCD Annunciator 5860 LCD Annunciator 6855 LCD Annunciator 6815-SLC Loop Expander 5815XL-SLC Loop Expander 5895XL Power Supply 5496 NAC Expander 5880-LED /IO Module 5865-LED Annunciator EVS-50W Voice Amplifier EVS-125W Voice Amplifier EVS-100W Voice Amplifier EVS-INT50W Voice Amplifier EVS-VCM Voice Control Module EVS-RVM- Remote Voice Module SK-NIC Network Interface Card		Section 9.2.2			
					Delete Module	Select Module	Section 9.2.3
					View Module List	Select Module	Section 9.2.4

Table 8-2: Programming Quick Reference Table

Menu		Options/Defaults			Comments	
Zone	Edit Zone	Select Zone	Edit Zone Name			Section 9.3.1.1
			Zone Properties	Verification Type	*1-Count	Section 9.3.1.2
					2-Count	
					Alarm Ver.	
					PAS	
					SNGL ILOCK	
					DBL ILOCK	
			Heat Temp Set	135° to 150°F	SD devices Section 9.3.1.2	
				135° to 190°F	SK Devices Section 9.3.1.2	
	Zone Accessory Opt	Single/ Multi-station Cadence	00-23	Section 9.3.1.3		
CO Single/ Multi station Cadence		00-23				
Local Zone		Yes				
		No				
View Zone Points	Select Zone to View			Section 9.3.2		
Group	Edit Group	Select Group	Group Name		Section 9.4.1.1	
			Group Properties	Voice Group	Y or N	Section 9.4.1.1
				Switch	1-64	
				Template Override	Y or N	
				Allow Sys Override	Y or N	
	Dynamic Act/ Template Override Cadence	00-23 (See Appendix D)				
View Group Points	Select Group			Section 9.4.2		
Edit OPG Template	Select template	Modify name and which OPG's are in template		Section 9.4.3		

Table 8-2: Programming Quick Reference Table

Menu		Options/Defaults			Comments	
Point	SD and SK Devices on Internal and External 6815 and SD on External 5815XL	Enter Pt	Select Module ⁴	UNUSED		Section 9.5
				MANUAL PULL		
				WATERFLOW	*LATCH	
					NON-LATCH	
				FIRE SUPERVSY	*LATCH	
					NON-LATCH	
				FIRE DRILL		
				SILENCE		
				RESET		
				P.A.S. ACK		
				ZONE AUX1	*LATCH	
					NON-LATCH	
				ZONE AUX2	*LATCH	
					NON-LATCH	
				SYSTEM AUX1	*LATCH	
					NON-LATCH	
				SYSTEM AUX2	*LATCH	
					NON-LATCH	
				DETECTOR		
				FIRE TAMPER	*LATCH	
					NON-LATCH	
				MANUAL RELEASE		
				INTERLOCK		
STATUS POINT						
CO DETECTOR SWITCH						
CO SUPERVISORY DET. SWITCH	*LATCH					
	NONLATCH					
EVS INPUT	*LATCH					
	NON-LATCH					

Table 8-2: Programming Quick Reference Table

Menu		Options/Defaults				Comments	
Point (cont.)	SD and SK Devices on Internal/ External 6815 and SD on External 5815XL	Enter Pt	Select Module ⁴	SWITCH ^{1,2,3, 4,5}	EVS TAMPER	*LATCH	Section 9.5
					NON-LATCH		
				EVS SUPER- VISORY	*LATCH		
					NON-LATCH		
				NOTIF ^{1,2,3,4, 5}	OUTPUT PT	Select Group	
					AUX CONST		
			AUX RESET				
			Select Sensor ⁴	RELAY ^{1,2,3,4, 5}	OUTPUT PT	Select Group	
					1,2,3,4,5,6		
					AUX RESET		
		SLC LED ^{1,5}		LED Number	1-80		
				1,5			
		LED Function		Notif			
				1,5	Unused		
		DETECTOR		2-WIRE	Select Zone		
		2,3,4		SMOKE			
		W-Gateway					
		2,3,4					
		W-SWITCH	Same as SWITCH				
		2,3,4,7					
W-RELAY	Same as Relay						
2,3,4,7							
UNUSED							
DETECTOR	PHOTO ^{1,2,3,4, 5}	No Accessory					
		SDR BAS					
		RLY BAS	1,2,3,4,5				
		I-SdrBa (Intelligent Sounder Base) ^{2,3,4}					
	ION ^{1,2,3,4}	No Accessory					
		SDR BAS	1,2,3,4,5				
		RLY BAS	1,2,3,4				
		I-SdrBa (Intelligent Sounder Base) ^{2,3,4}					

Table 8-2: Programming Quick Reference Table

Menu		Options/Defaults				Comments	
Point (cont.)	SD and SK Devices on Internal and External 6815 and External 5815XL (cont.)	Enter Pt	Select Sensor	DETECTOR 1,2,3,4,5	HEAT ^{1,2,3,4,5}	No Accessory	Section 9.5
					SDR BAS 1,2,3,4,5		
					RLY BAS 1,2,3,4,5		
					I-SdrBa (Intelligent Sounder Base) ^{2,3,4}		
					PHOTO DUCT ^{1,2,3,4,5}	No Accessory	
					DCT RLY		
					ACCLIMATE ^{2,3,4}	No Accessory	
						SDR BAS	
						RLY BAS	
						I-SdrBa (Intelligent Sounder Base)	
				HEAT-HT ^{2,3,4}	No Accessory		
					SDR base		
					RLY base		
					I-SdrBa (Intelligent Sounder Base)		
				PHOT- HEAT ^{2,3,4}	No Accessory		
					SDR BAS		
					RLY BAS		
					I-SdrBa (Intelligent Sounder Base)		
				BEAM ^{2,3,4}			
				SUP DET 1,2,3,4,5	Same function as DETECTOR	LATCH	
NON-LATCH							

Table 8-2: Programming Quick Reference Table

Menu		Options/Defaults				Comments	
Point (cont.)	SD and SK Devices on Internal and External 6815 and External 5815XL (cont)	Enter Pt	Select Sensor ⁴	CO FIRE ^{2,3,4}	CO ALARM/ FIRE ALARM	No Accessory	Section 9.5
						SDR BAS	
						RLY BAS	
						I-SdrBA (Intelligent Sounder Base)	
					CO ALARM/ FIRE SUPR	No Accessory	
						SDR BAS	
						RLY BAS	
						I-SdrBA (Intelligent Sounder Base)	
					CO SUPR/ FIRE ALARM	No Accessory	
						SDR BAS	
						RLY BAS	
						I-SdrBA (Intelligent Sounder Base)	
				CO SUPR/ FIRE SUPR	No Accessory		
					SDR BAS		
RLY BAS							
I-SdrBA (Intelligent Sounder Base)							
W-Detector 2,3,4,7	Photo						
	Photo-Heat						
	Heat						
W-SUP DET 2,3,4,7	Same as W- Detector						

Table 8-2: Programming Quick Reference Table

Menu		Options/Defaults			Comments		
Point (cont.)	Internal Power and External Power	Enter Pt /Select Function (cont.)	Select Sensor	SLC LED (SD only)	LED Output	LED Function	Section 9.5
				UNUSED			
				B NOTIF	NOTIF OUTPUT	Select Group Super-vised Yes or No	
					CONTROL CIRCUIT		
				A NOTIF	NOTIF OUTPUT	Select Group Super-vised Yes or No	
					CONTROL CIRCUIT		
				AUX PWR	CON-STANT		
					AUX RESET		
					AUX DOOR		
					AUX SYNC ⁸		
				B SWITCH	MANUAL PULL	Latch and Non-Latch feature only appear for WATERFLOW,FIRE SUPERVISORY, FIRE TAMPER, ZONE AUX1, ZONE AUX2, SYSTEM AUX1, SYSTEM AUX2., EVS INPUT, EVS TAMPER, and EVS SUPERVISORY.	
					WATER- FLOW		
					FIRE SUPER- VISORY		
					FIRE TAMPER		
					FIRE DRILL		
					SILENCE		
					RESET		
					P.A.S. ACK		
				ZONE AUX 1			
				B SWITCH	ZONE AUX2	Latch and Non-Latch feature only appear for WATERFLOW,FIRE SUPERVISORY, FIRE TAMPER, ZONE AUX1, ZONE AUX2, SYSTEM AUX1, SYSTEM AUX2., EVS INPUT, EVS TAMPER, and EVS SUPERVISORY.	
SYSTEM AUX1							
SYSTEM AUX2							
MANUAL RELEASE							
INTER-LOCK							
EVS INPUT	If EVS INPUT is selected choose associated EVENT						

Table 8-2: Programming Quick Reference Table

Menu		Options/Defaults			Comments		
Point (cont.)	Internal Power and External Power	Enter Pt /Select Function (cont.)	Select Sensor		EVS TAMPER	Latch and Non-Latch feature only appear for WATERFLOW, FIRE SUPERVISORY, FIRE TAMPER, ZONE AUX1, ZONE AUX2, SYSTEM AUX1, SYSTEM AUX2., EVS INPUT, EVS TAMPER, and EVS SUPERVISORY	
					EVS SUPERVISORY		
					STATUS POINT		
				A SWITCH	Same as B SWITCH		
				B DETECT	2-WIRE SMOKE		
					4-WIRE SMOKE		
					CO 4 WIRE DET		
				A DETECT	2-WIRE SMOKE		
					4-WIRE SMOKE		
					CO 4 WIRE DET		
Select Group or Zone Number				Group or Zone selection will appear depending on the function selected			
Edit Name	Enter Name						
5880/5865/EVS-Series Amplifiers	Enter Point #	UNUSED			Section 9.5.4		
		NOTIF					
		Select Group					
		Edit Name	Enter Name				
System Options	Communication Options	Auto Time Test	Set the Hour	*02:00AM	Section 9.6.1.1		
			Set the Minutes				
			Select AM/PM				
			Enter Interval	24 hrs, 12 hrs, *6 hrs, 4 hrs			
		Phone Lines	For each phone line (1 & 2) select:				Section 9.6.1.2
			Dialing Prefix	Up to 9 digits	*none		
			# of Answer Rings	Range: 00-15	*06		
			Select Dialing Option	TT	*TT		
				TT/PL			
				PULSE			
			Rotary Pulse Format	U = 60/40	*U		
				E = 66/34			
			Dial Tone Disabled	Y or N	*N		
			Monitor Line	Y or N	*N		
			Answering Machine Bypass	Y or N	*N		
			Phone Line Unused	Y or N	*N		

Table 8-2: Programming Quick Reference Table

Menu		Options/Defaults			Comments	
System Options cont	Communication Options	Edit Ethernet	IP Address		Section 9.6.1.3	
			Subn Mask			
			SubNet			
			Default Gateway			
				DHCP Enable		
	AlarmNet Timers	Ethernet Supervise	75 sec, 90 Sec, 3 min, 5 min, 1 hr, 24 hrs, 30 days, None	*5 Minutes	Section 9.6.1.4	
		Cellular Supervise	24Hrs, 30 days, none	*24 Hours		
		Old Alarm Time	10 min, 15 min, 30 Minutes, 1 hr, 2 hrs, 4 hrs, 8 hrs, 12 hrs, 24hrs, none	*30 Minutes		
	Phone Line Gains	Dialing	High	*High	Section 9.6.1.5	
			Low			
			Normal			
		Reporting	Low	*Low		
	Normal					
	High					
	Time Options	Water Flow Delay	0 - 90 Seconds	*1 sec	Water Flow delay is the number of seconds before a water flow alarm is generated. Section 9.6.2.1	
		Alarm Verify	60 to 250 seconds	*60 sec	Alarm Verification time section 9.6.2.2	
		Low AC Report Time	0 - 30 hours	*3 hrs	Low AC Report Delay. Section 9.6.2.3	
		AC Freq:	50 Hz	*60Hz	Section 9.6.2.4	
			60 Hz			
			Internal			
Clock Display Format		AM/PM	*AM/PM	System Clock Format (AM/PM or military). Section 9.6.2.5		
	MIL					
Auto-resound	4 hours	*24 hours	Section 9.6.2.6			
	24 hours					

Table 8-2: Programming Quick Reference Table

Menu		Options/Defaults			Comments
System Options cont	Miscellaneous Options	SYNC Strobes when Silenced	Y	*N	Section 9.6.3.1
			N		
		Auto Display Events	Y	*N	Section 9.6.3.2
			N		
	Daylight Saving Options	Auto Daylight Saving Time	Y	*Y	Section 9.6.4.1
			N		
		DST Start	Select week: 1st, 2nd, 3rd, 4th or Last	Select month	Section 9.6.4.2
	DST End				
Edit Banner	Refer to Appendix B			Section 9.6.5	
SLC Family	SD			Section 9.6.6	
	SK				
Jump Start AutoPrg	Y (Yes) N (No)			Section 9.7	
Restore Defaults	Y (Yes) N (No)			See Section 9.8	
Voice Options	VCM Maintenance	PC Connection		Section 9.9	
		Local Recording			
*=Default					

1. Available on 5815XL External.
2. Available on 6815 External.
3. Available on 6815 Internal.
4. Available with SLC Family as SK.
5. Available with SLC Family as SD.
6. Requires EVS module programmed into the panel.
7. Requires wireless Gateway.
8. Aux Sync setting is only applicable for the B200S Sounder Base.

Section 9

Programming

This section of the manual describes how to manually program the control panel from the built-in annunciator. Each subsection discusses these menu options in detail. All options described in this section can be performed using HFSS Honeywell Fire Software Suite.

Important!

Before any customized programming is done, JumpStart[®] should be run first. After JumpStart[®] is run, thoroughly test the system. The reason the system should be tested after JumpStart[®] is because JumpStart[®] automatically programs the system, searching for and configuring all SLC and SBUS devices it finds. JumpStart allows you to confirm the integrity of the installation prior to performing any custom programming. After determining that the hardware is properly installed, custom programming can be performed.

9.1 UL 864 / UL 2572 Programming Requirements

NOTICE TO USERS, INSTALLERS, AUTHORITIES HAVING JURISDICTION, AND OTHER INVOLVED PARTIES: This product incorporates field programmable software. In order for the product to comply with the requirements in the Standard for Control Units and Accessories for Fire Alarm Systems, UL 864 and UL 2572, certain programming features or options must be limited to specific values or not used at all as indicated below.

Programming Option	Menu Item	Permitted in UL 864 (Y/N)	Permitted in UL 2572 (Y/N)	Possible Settings	Settings Permitted in UL 864	Settings Permitted in UL 2572
Time Options	Auto-resound	Yes	Yes	4 hrs, 24hrs	4 hours if using SWIFT devices	4 hours if using SWIFT devices
Time Options	Low AC Report Delay	Yes	Yes	0–30 hours	1–3	1–3
Display Oldest Event	Y (Enabled)	Yes	Yes	Yes & No	Yes	Yes
	N (Disabled)	No	No	Yes & No	No	No
Initial Delay	0-28	Yes	Yes	0-28	3	3
Inter Message Delay	4-32	No	No	4-32	4-32	4-28
Alarm Verification	Alarm Verification	Yes	Yes	60-250 (confirmation period)	60	60
Auto Reset EVS MIC Triggered Event	Auto Reset EVS MIC Triggered Event	Yes	Yes	Never Timer Event Disabled	Never Timer Event Disabled	Never Timer Event Disabled
EVS Input	EVS Input	Yes	Yes	Latching Non-Latching	Latching	Latching
Event Priority	CO Alarm	No	No	Yes & No	No	No

9.2 Modules

This section lists the options available under the module option in the program menu. The following modules are available for the control panel: 6815 & 5815XL SLC expander, 5860, 6860 & 6855 remote fire alarm annunciators, 5824 serial/parallel printer interface module, 5496 intelligent power module, 5895XL intelligent power module, 5880 LED I/O module, and 5865 LED annunciator, EVS-50W, EVS-100W, EVS-INT50W or EVS-125W audio/voice amplifiers, EVS-VCM voice control module, SK-NIC network interface card, and EVS-RVM remote voice module.

9.2.1 Edit Modules

The features that can be edited when this option is selected are module ID, module name, class of wiring (Class A or Class B), or features that are specific to the module to be edited.

To edit an existing module:

1. Enter the installer code. The panel will automatically go to the main menu.
2. Select 7 for Program Menu.
3. Press 1 to enter module menu.
4. Press 1 to edit a module.
5. Use the Up or Down arrow to select the module you wish to edit, then press ENTER.

9.2.1.1 Editing Module ID

6. Press the up or down arrow key to modify the module ID.

Note: Internal devices and SK-NIC are not able to have their module ID edited.

9.2.1.2 Naming Modules

You can assign an English name to a system hardware module to make it easier to recognize on a display.

7. If you wish to edit the module's name, press the ENTER on the module's name. Then press the number keys corresponding to the character to select each character for the module's name (or press the right arrow to bypass editing the name).

Press the right arrow to move to the next character.

Note: See Appendix B for editing names

Default name for the Internal SLC module (no customization)

```
Internal SLC Loop
Module ID: 97
Internal SLC
<Module Name> More ▾
```

Use up or down arrow key to select Mode. Press the number until the character wanted is shown. Press left/rt arrow

```
<Enter Module Name> Enter: Accept
Internal Power Supply
1[abc] 2[def] 3[ghi] 4[jkl] 5[mno]
6[pqr] 7[stu] 8[vwx] 9[yz ] 0[Spc]
```

Figure 9-1 Edit module Name Programming Screen Example

9.2.1.3 Changing Module Options

Each module has a unique set of options that specifically applies to the functionality of the module being edited.

8. Use the left and right arrow keys to move between available options.

9. Option settings are edited by pressing the up or down arrow.

9.2.2 Adding a Module

To add a new hardware module to the system, follow these steps:

You must be in the Main Menu to perform this task. If necessary, enter the Installer Code.

1. Enter the installer code. The panel will automatically go the main menu.
2. Select 7 for Program Menu.
3. Press 1 to enter module menu.
4. Press 2 to add a module.
5. From the next screen, select the number that corresponds to choose a module type to add from the <New Module Type> screen.

The screen will display “Adding module [#]...” for a few moments. You will be returned to the <New Module Type> screen where you can add additional modules if desired.

You must save changes when you exit the Program Menu or the new module will not be added.

Note: If you Add a Module that has not been physically connected, the panel will go into trouble after it reinitializes (when you exit the Program Menu). When the new module is attached, the trouble will correct itself automatically.

9.2.3 Deleting a Module

To delete a module, follow these steps:

You must be in the Main Menu to perform this task. If necessary, enter the Installer Code.

1. Enter the installer code. The panel will automatically go the main menu.
2. Select 7 for Program Menu.
3. Press 1 to enter module menu.
4. Select module to be deleted.
5. Press 3 to delete a module.
6. A warning screen will display. If you want to proceed with deleting the module, select Yes. To cancel, select No.

9.2.4 View Module List

To view a list of all modules, follow these steps:

1. Enter the installer code. The panel will automatically go the main menu.
2. Select 7 for Program Menu.
3. Press 1 to enter module menu.
4. Press 4 to view module list.

9.3 Zone

Through the zone option in the program menu you can edit and view zone points. Selections made here affect all detectors and switches in the zone. Up to 999 zones can be used in the system.

9.3.1 Edit Zone

Features that can be edited through the edit zone option are zone name, zone properties (which includes zone type and detector sensitivity), and zone accessory options.

To edit a zone, follow these steps:

1. Enter the installer code. The panel will automatically go to the main menu.
2. Select 7 for Program Menu.
3. Press 2 to enter zone menu.
4. Press 1 to edit a zone.
5. Enter the zone number, then press ENTER.

9.3.1.1 Edit Zone Name

6. Press 1 to edit the selected zone name.

You can use words to display a descriptive name for a zone.

Note: See Appendix B for editing names.

9.3.1.2 Edit Zone Properties

Zone properties consist of alarm delay characteristics, heat detector sensitivity.

1. Do steps 1 through 5 of Section 9.3.1.
2. Press 2 to edit the properties of the selected zone.

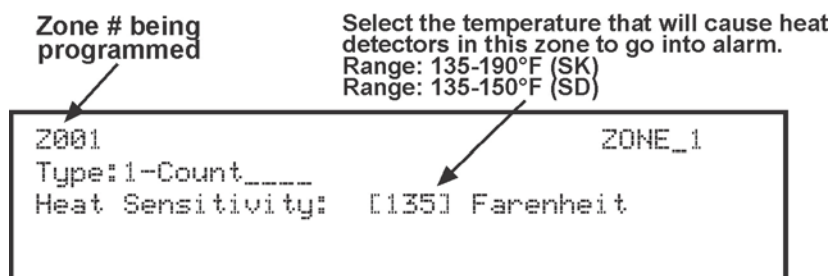

Figure 9-2 Editing Zone Properties

Alarm Delay Characteristics

The programmed zone type is provided for user reference only. To modify the zone type, use the HFSS Honeywell Fire Software Suite.

Table 9-1 list the detector characteristics and a description of each.

Table 9-1: Alarm Detector Characteristics

Type of Delay	Description
1-Count	One Count (No Delay). When this option is enabled, an alarm occurs immediately when a single device of any of the following types goes into alarm: detector, manual pull, water flow, Zone Aux1 or Zone Aux2. This is considered the most typical operation and is the default for all zones.
2-Count	<p>When this type of alarm delay is used, two or more detectors within the zone must go into alarm in order for the zone to report an alarm. Switches of type manual pull, Detector Switch, water flow, Zone Aux1 and Zone Aux2 are an exception; they will cause an alarm when only one switch is in alarm.</p> <p>When a single detector is in alarm in a 2-Count zone, the system enters a prealarm condition. In a prealarm condition, the touchpad PZT beeps and the annunciator display indicates that a prealarm has occurred. If the zone has been mapped to an output group for the prealarm event, the output group will activate. The prealarm will not be reported to the central station.</p> <p>When two count is used, detector spacing shall be cut in half. You should, not use the alarm verification feature, and no delay shall be used.</p>
Alarm Verification	Alarm verification is an optional false alarm prevention feature that verifies an alarm condition by resetting the smoke detector. If the alarm condition still exists by the time the reset cycle has completed, the detector will go into alarm. If the detector is no longer in alarm, no report will go to the central station. The alarm verification sequence is ignored if the zone is already in alarm.
P.A.S.- Positive Alarm Sequence	<p>This option is intended to be used with an acknowledge switch. An alarm is delayed for 15 seconds, giving on-site personnel a chance to investigate the alarm. If the acknowledge switch is not activated within 15 seconds, an alarm occurs automatically.</p> <p>If this option is enabled for a zone, the zone will respond to an alarm condition as follows:</p> <ul style="list-style-type: none"> • The zone will not go into alarm for 15 seconds to allow an on-site operator to activate the acknowledge switch. • If the operator does not press the acknowledge switch within 15 seconds, the zone will go into alarm. • If the operator presses the acknowledge switch within 15 seconds, a 180-second time-frame will begin counting down. This time-frame allows the operator to investigate the cause of the alarm. <p>If the operator performs a reset within 180 seconds, the alarm will not occur. If the operator does not perform a reset within 180 seconds, an alarm will occur automatically.</p> <ul style="list-style-type: none"> • The P.A.S. feature will be overridden if another alarm occurs.
Single Interlock	See Section 10.7.1 for single interlock releasing operation.
Double Interlock	See Section 10.7.2 for double interlock releasing operation.
Note: SK-Fire-CO and other CO detectors can only be installed in a 1 count zone.	

Heat Temperature Setting

Use this feature to set the temperature at which high temperature detectors will respond. All detectors in the zone will respond in the same way. The range for SK-Heat-HT heat detector is from 135°F to 190°F and the range for SD505-HEAT is 135° to 150°F.

The high temperature SK heat detectors are absolute temperature devices. This means that they respond to an alarm immediately if the temperature in the zone goes above the programmed temperature.

3. Enter the temperature at which the heat detector will respond, or use the up or down arrow key to scroll through the range, or enter directly from the number keys on the annunciator, then press ENTER.

- Use the up or down arrow key to scroll through the range or enter directly from the number keys on the annunciator, then press ENTER.

9.3.1.3 Zone Accessory Options

- Do steps 1 through 5 of Section 9.3.1.
- Press 3 to edit the Zone's Accessory options.

Single or Multi-Station cadence pattern (choose from Patterns 00 to 02, 23 if using SK. Choose from 00-16, 23 if using SD devices). See Appendix D.

CO Single and Multistation Cadence (choose from Cadence Patterns 00 to 02, 23 for SK devices).

Note: The B200S Sounder base provides the recommended CO cadence pattern.

Local Zone (choose Y or N, for Yes or No).

Note: If the SLC protocol is changed from SD to SK series and the cadence is no longer valid for SK, the zone cadence will be set to constant on.

9.3.2 View Zone Points

To view the points in a zone, follow these steps:

- Enter the installer code. The panel will automatically go to the main menu.
- Select 7 for Panel Programming.
- Press 2 to enter zone menu.
- Press 2 to view zone points.
- Enter the number of the zone you wish to view, then press ENTER.

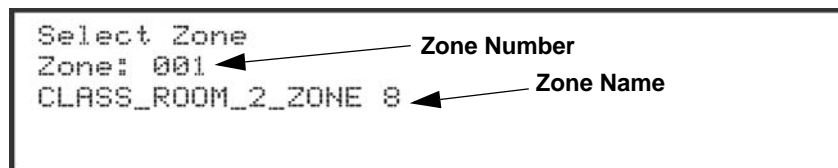

Figure 9-3 View Zone Points Screen

9.4 Group

An output group is made up of output points that have been programmed to respond in the same way. Output groups simplify programming because you only have to program the output characteristics that are common to all of the group points once, instead of programming each individual point. Once you have defined the characteristics of output groups, you can assign each point to the appropriate group. All valid output points are assigned to only one output group. Unused points are not assigned to any output group. Up to 999 output groups can be defined.

9.4.1 Edit Group

In the edit group option you can program the name of an output group (Section 9.4.1.1) and change the properties (Section 9.4.1.2) of that group.

To edit a group, follow these steps:

- Enter the installer code. The panel will automatically go the main menu.
- Select 7 for Program Menu.

3. Press 3 to enter group menu.
4. Press 1 to edit group.
5. Enter the number of the group you wish to edit, then press ENTER.

9.4.1.1 Edit Group Name

6. To edit the group name, press 1.

You can use words to display a descriptive name for a group.

Note: See Appendix B for editing names.

9.4.1.2 Edit Group Properties

7. To edit the group properties, Press 2 from the edit group menu.

Note: These settings only apply to non-voice groups

- Select Y for voice group and N for non-voice group.
- Select / Dynamic Activation switch number: used when the group is defined as a voice group; or as a non-voice group where Dynamic Activation is used. This option links the output group with a voice select switch on a VCM, RVM, or switch expander for dynamic activation/deactivation. See Section 11.2.3.2 for more information.
- Template Override is shown when set to Yes.
- Dynamic Activation -Is shown if a non-voice group is assigned to a Select/Dynamic Activation switch number
- Dynamic Activation / Template Override Cadence. (This is shown when the Template override is set to Yes or if a non-voice group is assigned a Select/Dynamic Activation switch number): this setting sets the cadence of the non-voice group mapped to voice select switch when activated using dynamic activation or by a template. See Sections 11.2.3.2 and 9.5 for more information..

Defining Output Group Type

Each output group is defined as either a voice output group or a non-voice output group. Output points that are audio circuits (all circuits on the EVS-50W, EVS-125W, EVS-100W, EVS-INT50W and EVS-CE4) can only be assigned to voice output groups. Output points that are non-voice circuits (all other points and circuits that are on all modules except the EVS-50W, EVS-125W, EVS-100W, EVS-INT50W and EVS-CE4) are assigned to non-voice output groups.

Each of the output groups defined as voice can be mapped to a particular switch and LED on the EVS-VCM/ EVS-RVM and EVS-SW24. This allows the user to see the state of the voice groups assigned to the switches. This also lets the user individually select which areas they want to do a live page into. Output groups not defined as voice groups can also be assigned to these switches as long as there is a voice group already assigned to the group. This allows for dynamically activating/deactivating both voice and strobes/other outputs in an area with a

single button press. See 11.2.3.2.

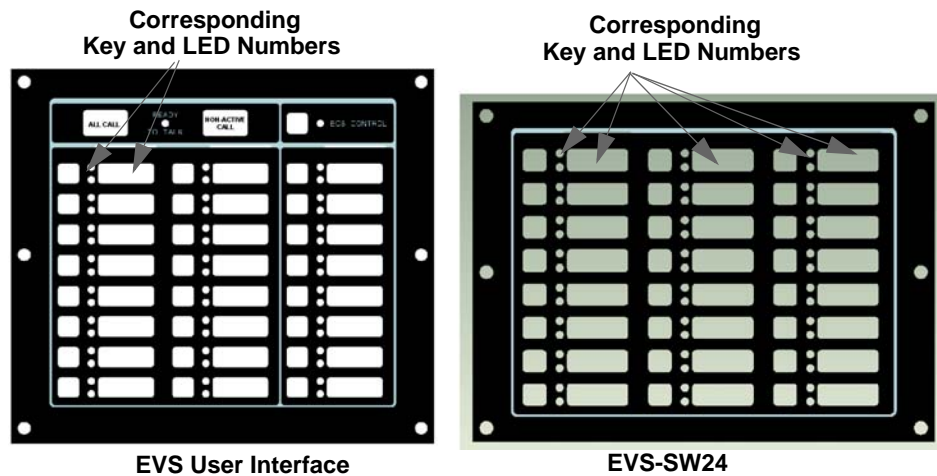

Figure 9-4 Corresponding Key and LED for Mapping Output Groups

Silencing Options

The following silencing options are available for each output group.

Table 9-2: Silencing Options

Optional Timers	Description
Silence Inhibit	Timed Silence after Inhibit. If this option is selected, the output group must be audible for a programmed number of minutes before it can be silenced. If the condition that caused the output to activate has not cleared during the time-frame, the output can be silenced. If you select this option, select the timeframe in the delay field. Range is 0-60 minutes.
Auto Silence	Silenceable. The output group will automatically silence after the timer expires. Range is 0-60 minutes.
Auto Unsilence	If this option is selected, the output group can be silenced for a programmed time-frame. If the condition that caused the output to activate has not cleared during the time-frame, the output reactivates. If you select this option, select the time-frame in the delay field. Range is 0-60 minutes.
Startup Delay	When a alarm is generated, the Output group will not activate until the timer expires assuming the event is still active. Range is 0-120 Seconds

9.4.2 View Group Points

1. Enter the installer code. The panel will automatically go to the main menu.
2. Select 7 for Panel Programming.
3. Press 3 to enter group menu.
4. Press 2 to view group points.
5. Enter the group number, then press ENTER.

```

Group:  G001
Point:  98:001
Number 1 of 8
    
```

9.4.3 Edit OPG Template

1. Enter the installer code. The panel will automatically go to the main menu.
2. Select 7 for Panel Programming.
3. Press 3 to enter group menu.
4. Press 3 to edit OPG Template.
5. Enter the Template number, then press ENTER
6. Press ENTER on the template name to edit the name.

You can use words to display a descriptive name for a group.

Note: See Appendix B for editing names.

7. Right arrow to the OPG and select YES or NO to select which output groups to include in the template.

9.5 Point

You may need to change characteristics of individual input points (detectors and switches) even after using JumpStart®. This section explains how to change options for: type of point, latching/non-latching, silenceable/non-silenceable, zone assignment (input points), detector accessory base options, group assignment (output points), and point name.

9.5.1 Point Programming For 5815XL Module

To program points on 5815XL Module, follow these steps:

1. Enter the installer code. The panel will automatically go to the main menu.
2. Select 7 for Program Menu.
3. Press 4 to enter point menu.
4. Press the Up or Down arrows to select the desired module. Refer to Section 8.5 Quick Reference Table for available choices. Press ENTER.
5. Enter the number of the point you wish to edit, then press ENTER.
6. Select the type of device by pressing the up or down arrow key. Refer to Table 9-3 under the column heading "Type Selection" for a list of choices.

Table 9-3: Programming Options for 5815XL Modules

Type Selection	Function	Latching Option	Comments
UNUSED			Select for SLC points that are unused.
DETECTOR	PHOTO		Spot photoelectric detectors.
	ION		Spot ionization detector.
	HEAT		Spot heat detector.
	PHOTO DUCT		Duct photoelectric detector.
	2-WIRE SMOKE		2-wire smoke detector.
SUP DET	PHOTO	Latching Non Latching	Use this option when you want a detector to indicate a supervisory alarm.
	ION		
	HEAT		
	PHOTO DUCT		

Table 9-3: Programming Options for 5815XL Modules

Type Selection	Function	Latching Option	Comments
SWITCH	MANUAL PULL		Use this switch type for manual pull stations. This input is always latched. The switch can clear only when an alarm is reset. This switch type has the highest fire priority; it overrides any other type of fire alarm.
	WATERFLOW	Latching	Use this switch type for monitoring water flow in a sprinkler system. Switch closure will cause a sprinkler alarm. Water flow switches can be programmed as latching or non-latching. You can program a delay of up to 90 seconds to be used with a water flow switch. The delay allows for normal, brief changes in sprinkler system water pressure. The water flow alarm will not activate unless the switch is active for the programmed delay time. If a delay is used, the system begins counting down when the switch closes. If the switch opens (restores) before the timer expires, a water flow alarm is not generated. If the water flow switch remains closed after the timer expires, a water flow alarm will be generated.
		Non Latching	
	FIRE SUPER-VISORY	Latching	Use this switch type for tamper monitoring of sprinklers and other fire protection devices. If a contact closes, a sprinkler supervisory event will be generated. Supervisory switches can be latching or non-latching.
		Non Latching	
	FIRE DRILL		System-level, non latching switch. This switch is an alternative way of causing a fire drill. It has the same operation as the fire drill option available from the annunciator. When the switch is activated, a fire drill begins; when the switch is de-activated, the fire drill ends.
	SILENCE		This system-level switch is an alternative way to silence the fire system. It has the same effect as pressing the Silence key.
	RESET		This system-level switch is an alternative way to reset the fire system. It has the same effect as pressing the Reset key.
	P.A.S. ACK		Positive acknowledge switch. This switch must be used in zones programmed as Positive Alarm Sequence (see 9.3.1.2). If an acknowledge switch closes when an alarm or trouble condition is not already in progress, a trouble will occur. You must use a UL listed normally open, momentary switch type. The switch must be rated at 5V, 100 mA (minimum) and be used with an EOL resistor for supervision.
	ZONE AUX1	Latching	Use these switch types if you want to monitor special zone-level conditions (such as dry contact from a remote power supply).
		Non Latching	
	ZONE AUX2	Latching	
		Non Latching	
	SYSTEM AUX1	Latching	Use these switch types if you want to monitor special system-wide conditions (such as dry contact from a remote power supply).
		Non Latching	
	SYSTEM AUX2	Latching	
		Non Latching	
DETECTOR		Used to monitor conventional 4-wire detectors, a contact closure will generate a detector alarm event.	
FIRE TAMPER	Latching	Performs identically to a supervisory switch, but will be indicated as a tamper switch on the LCD annunciator.	
	Non Latching		
MANUAL RELEASE		Manual release switch	

Table 9-3: Programming Options for 5815XL Modules

Type Selection	Function	Latching Option	Comments
SWITCH (cont.)	INTERLOCK		Interlock release switch input.
	STATUS POINT		
	EVS INPUT	Latching	User also has EVS Event Number 1-8 option for EVS INPUT. Only available when an EVS-VCM is installed in the system.
		Non Latching	
	EVS TAMPER	Latching	
		Non Latching	
	EVS SUPERVISORY	Latching	
Non Latching			
CO DETECT SW		CO Detector Switch	
CO SUPERVISORY DETECT SW		CO Supervisory Detector Switch	
NOTIF	OUTPUT PT	Select Group	Output point, a general use notification type. Use for driving standard notification appliances.
	AUX CONST		Use constant power for applications that require a constant auxiliary power source. Power is always present at constant circuits.
	AUX RESET		Use for auxiliary power, resettable applications. See Section 4.16.3 for a description of how this option operates.
	AUX DOOR		Use for auxiliary power, door holder applications. For example, if you were using an auxiliary power supply for door holders, you would use this option. See Section 4.16.3 for a description of how this option operates.
RELAY	OUTPUT PT	Select Group	Output point, a general use relay type. Use for applications requiring a relay, such as fan shutdown, elevator recall, and so on.
	AUX RESET		Use for auxiliary power, resettable applications. See Section 4.16.3 for a description of how this option operates.
	AUX DOOR		Use for auxiliary power, door holder applications. For example, if you were using an auxiliary power supply for door holders, you would use this option. See Section 4.16.3 for a description of how this option operates.
SLC LED	LED NUMBER	01-80	For use with SD devices only. 80 sub addresses on LED.
	LED FUNCTION	Unused	
		NOTIF	Notification can have group number.

9.5.2 Point Programming For 6815 Module

To program for points on an 6815 module, follow these steps:

1. Enter the installer code. The panel will automatically go to the main menu.
2. Select 7 for Panel Programming.
3. Press 4 to enter point menu.
4. Press the up or down arrow key to select the desired module. Refer to Section 8.5 Quick Reference Table for available choices. Then press ENTER.
5. Select S for sensor or M for module. (SK Only)
6. Enter the number of the point you wish to edit, then press ENTER.

- Select the type of device by pressing the up or down arrow key. Refer to Table 9-4 under the column heading “Type Selection” for a list of choices.

Table 9-4 Point Programming for 6815

Type Selection	Function	Latching Option	Comments
UNUSED			Select for SLC points that are unused.
DETECTOR	PHOTO		Spot photoelectric detectors.
	ION		Spot ionization detector.
	HEAT		Spot heat detector.
	PHOTO DUCT		Duct photoelectric detector.
	ACCLIMATE		Acclimate photoelectric detector.
	HEAT HT		High temperature heat detector.
	PHOTO-HEAT		Photoelectric detector with heat sensor.
	BEAM		Beam smoke detector.
SUP DET	PHOTO	Latching Non Latching	Use this option when you want a detector to indicate a supervisory alarm.
	ION		
	HEAT		
	PHOTO DUCT		
	ACCLIMATE		
	HEAT HT		
	PHOTO-HEAT		
	BEAM		
CO SMOKE DETECTOR	CO ALRM / FIRE ALRM		
	CO ALRM / FIRE SUPR		
	CO SUPR / FIRE ALRM		
	CO SUPR / FIRE SUPR	Latching Non Latching	Detectors programmed as Supervisory can be latching or non-latching.
W-DETECTOR	Photo		Wireless photoelectric detector
	Photo-Heat		Wireless heat detector
	Heat		
W-SUP-DET	Same as W-Detector	Latching Non Latching	
SWITCH	MANUAL PULL		Use this switch type for manual pull stations. This input is always latched. The switch can clear only when an alarm is reset. This switch type has the highest fire priority; it overrides any other type of fire alarm.
	WATERFLOW	Latching	Use this switch type for monitoring water flow in a sprinkler system. Switch closure will cause a sprinkler alarm. Water flow switches can be programmed as latching or non-latching.
		Non Latching	You can program a delay of up to 90 seconds to be used with a water flow switch. The delay allows for normal, brief changes in sprinkler system water pressure. The water flow alarm will not activate unless the switch is active for the programmed delay time. If a delay is used, the system begins counting down when the switch closes. If the switch opens (restores) before the timer expires, a water flow alarm is not generated. If the water flow switch remains closed after the timer expires, a water flow alarm will be generated.

Table 9-4 Point Programming for 6815

Type Selection	Function	Latching Option	Comments
SWITCH (cont.)	FIRE SUPER-VISORY	Latching	Use this switch type for tamper monitoring of sprinklers and other fire protection devices. If a contact closes, a sprinkler supervisory event will be generated. Supervisory switches can be latching or non-latching.
		Non Latching	
	FIRE DRILL		System-level, non latching switch. This switch is an alternative way of causing a fire drill. It has the same operation as the fire drill option available from the annunciator. When the switch is activated, a fire drill begins; when the switch is de-activated, the fire drill ends.
	SILENCE		This system-level switch is an alternative way to silence the fire system. It has the same effect as pressing the Silence key.
	RESET		This system-level switch is an alternative way to reset the fire system. It has the same effect as pressing the Reset key.
	P.A.S. ACK		Positive acknowledge switch. This switch must be used in zones programmed as Positive Alarm Sequence (see 9.3.1.2). If an acknowledge switch closes when an alarm or trouble condition is not already in progress, a trouble will occur. You must use a UL listed normally open, momentary switch type. The switch must be rated at 5V, 100 mA (minimum) and be used with an EOL resistor for supervision.
	ZONE AUX1	Latching	Use these switch types if you want to monitor special zone-level conditions (such as dry contact from a remote power supply).
		Non Latching	
	ZONE AUX2	Latching	
		Non Latching	
	SYSTEM AUX1	Latching	Use these switch types if you want to monitor special system-wide conditions (such as dry contact from a remote power supply).
		Non Latching	
	SYSTEM AUX2	Latching	
		Non Latching	
	DETECTOR		Used to monitor conventional 4-wire detectors, a contact closure will generate a detector alarm event.
	FIRE TAMPER	Latching	Performs identically to a supervisory switch, but will be indicated as a tamper switch on the LCD annunciator.
		Non Latching	
	MANUAL RELEASE		Manual release switch
	INTERLOCK		Interlock release switch input.
	STATUS POINT		
	EVS INPUT	Latching	User also has EVS Event Number 1-8 option for EVS INPUT. Only available when an EVS-VCM is installed in the system.
		Non Latching	
	EVS TAMPER	Latching	
		Non Latching	
EVS SUPER-VISORY	Latching		
	Non Latching		
CO DETECT SWITCH		CO Detector Switch	
CO SUPERVISORY DETECT SWITCH	Latching	CO Supervisory Detector Switch	
	Non Latching		

Table 9-4 Point Programming for 6815

Type Selection	Function	Latching Option	Comments
NOTIF	OUTPUT PT	Select Group	Output point, a general use notification type. Use for driving standard notification appliances.
	AUX CONST		Use constant power for applications that require a constant auxiliary power source. Power is always present at constant circuits.
	AUX RESET		Use for auxiliary power, resettable applications. See Section 4.16.3 for a description of how this option operates.
	AUX DOOR		Use for auxiliary power, door holder applications. For example, if you were using an auxiliary power supply for door holders, you would use this option. See Section 4.16.3 for a description of how this option operates.
RELAY	OUTPUT PT	Select Group	Output point, a general use relay type. Use for applications requiring a relay, such as fan shutdown, elevator recall, and so on.
	AUX RESET		Use for auxiliary power, resettable applications. See Section 4.16.3 for a description of how this option operates.
	AUX DOOR		Use for auxiliary power, door holder applications. For example, if you were using an auxiliary power supply for door holders, you would use this option. See Section 4.16.3 for a description of how this option operates.
W-GATEWAY			
W-SWITCH	Same as SWITCH		
W-RELAY	Same as RELAY		When a wireless relay is in use, module device count must be limited to 109 modules per loop. This includes wired and wireless modules that are on the same loop. The module address must be within 1-109.

9.5.3 Point Programming For Internal or External Power Module

To program for an internal or external power module points:

1. Enter the installer code. The panel will automatically go to the main menu.
2. Select 7 for Program Menu.
3. Press 4 to enter point menu.
4. Press the up or down arrows to select the desired module. Refer to Section 9.5.3 for available choices, then press ENTER.
5. Enter the number of the circuit or point you wish to edit. Refer to Table 9-5 for available selections, then press ENTER.
6. Select the type by pressing the up or down arrows, then press ENTER.
7. Select the function by pressing the up or down arrows, then press ENTER.
8. Select the group by pressing the up or down arrows, then press ENTER.
9. Edit point name. See Section Appendix B. Or, press the right arrow to skip point name edit.

10. Repeat steps 1 through 9 for all circuits.

Table 9-5: Menu choices for Internal/External Power Module

Choices	Type Selections	Function Selections for each Type	Comments	
Enter Point				
Select Type	UNUSED			
	B NOTIF	NOTIF Output		
	A NOTIF	Control Circuit		
	AUX_PWR	CONSTANT		Constant auxiliary power.
		AUX RESET		Resettable auxiliary power.
		AUX DOOR		Door holder auxiliary power.
		Aux SYNC		Aux Power for System Sensor
	B SWITCH	MANUAL PULL		Refer to comments column of Table 9-3 for description of these options. Latch or Non-latching feature only appears for WATERFLOW, FIRE SUPERVISORY, FIRE TAMPER, ZONE AUX1, ZONE AUX2, SYSTEM AUX1, SYSTEM AUX2, EVS INPUT, EVS TAMPER, and EVS SUPERVISORY.
		WATERFLOW		
		FIRE SUPERVISORY		
		FIRE TAMPER		
		FIRE DRILL		
		SILENCE		
		RESET		
		P.A.S. ACK		
		ZONE AUX1		
		ZONE AUX2		
		SYSTEM AUX1		
		SYSTEM AUX2		
		MANUAL RELEASE		
		INTERLOCK		
		STATUS POINT		
	A SWITCH	EVS INPUT		User also has EVS Event Number 1-8 option for EVS INPUT. Only available when an EVS-VCM is installed in the system.
		EVS TAMPER		
		EVS SUPERVISORY		
	A SWITCH	Same as B SWITCH		
		B DETECT	2-WIRE SMOKE	Used for Class B, 2-wire detectors.
			4-WIRE SMOKE	Used for Class B, 4-wire detectors.
			CO 4-WIRE DET	Used for Class B, 4-wire CO detectors.
	CO 4-WIRE SUP DET		Latching or Non-latching used for Class B, 4-wire CO Supervisory detectors	
A DETECT	2-WIRE SMOKE	Used for Class A, 2-wire detectors.		
	4-WIRE SMOKE	Used for Class A, 4-wire detectors.		
	CO 4-WIRE DET	Used for Class A, 4-wire CO detectors.		
	CO 4-WIRE SUP DET	Latching or Non-latching used for Class A, 4-wire CO Supervisory detectors		

9.5.4 Point Programming For 5880, 5865, EVS-50W, EVS-INT50W, EVS-100W, EVS-125W and EVS-CE4 Modules

To program 5880, 5865, EVS-50W, EVS-INT50W, EVS-100W, EVS-125W, or EVS-CE4 module points:

1. Enter the installer code. The panel will automatically go to the main menu.
2. Select 7 for Program Menu.
3. Press 4 to enter point menu.
4. Press the up or down arrows to select the desired module. Refer to Section 8.5 for available choices. Then press ENTER.

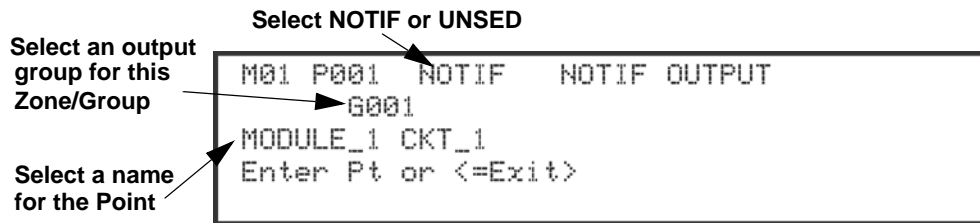

Figure 9-5 Programming Points as Outputs for the 5880 Module
 Select Switch or Unused Select Function

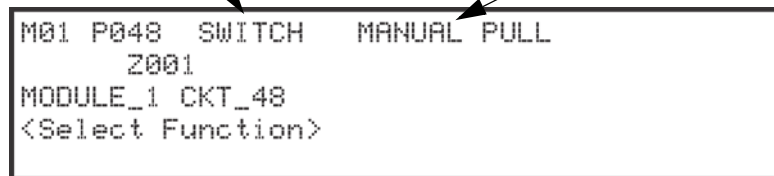

Figure 9-6 Programming Points as Inputs for the 5880 Module

5. Enter the point number, then press ENTER.
6. Press the up or down arrows to select the type (notification or unused). Press ENTER.
7. Press the up or down arrows to select the desired group.
8. Press ENTER.
9. Edit point name. See Section 9.6. Or, press the right arrow to skip module name edit.
10. Repeat Steps 1 through 9 for all points.

9.5.5 Point Programming For EVS-VCM and EVS-RVM Modules

To program EVS-VCM and EVS-RVM module points:

1. Enter the installer code.
2. Select 7 for Program Menu.
3. Press 4 to enter point menu.
4. Press the up or down arrows to select the desired module. Refer to Section 8.5 for available choices. Press ENTER.
5. Enter the point number. Press ENTER.
6. Press the up or down arrows to select the type (Switch or unused). Press ENTER.
7. Press the up or down arrows to select the function. Press ENTER.

8. Use the up or down arrows to modify and remaining options and use ENTER to move to the next field.
9. Edit module name. See Section 9.2.1.2. or, Press the right arrow to skip module name edit.
10. Repeat Steps 1 through 9 for all points.

Table 9-6: Point Programming Options for EVS-VCM and EVS-RVM

Choices	Type Selections	Function Selections for each Type	Comments
EVS-VCM/EVS-RVM	UNUSED		
	SWITCH	MANUAL PULL	Refer to comments column of Table 9-5 for description of these options. Latch or Non-latching feature only appears for waterflow, supervisory, tamper, zone aux1, zone aux2, system aux1, and system aux2.
		WATERFLOW	
		FIRE SUPERVISORY	
		TAMPER	
		FIRE DRILL	
		SILENCE	
		RESET	
		PAS_ACK	
		ZONE AUX1	
		ZONE AUX2	
		SYSTEM AUX1	
		SYSTEM AUX2	
		MANUAL RELEASE	
		INTERLOCK	
		STATUS POINT	
		VOICE AUX STATUS 1-2	
		VOICE AUX EVS 1-4	
		Background Music	
		EVS INPUT	
EVS TAMPER	Only available when an EVS-VCM is installed in the system to the EVS-VCM / EVS-RVM choice part.		
EVS SUPERVISORY			

9.6 System Options

This section of the manual explains how to customize software options that affect general operation of the system. This includes such items as: Communication Options, Time Options, Miscellaneous Options, Daylight Saving Options, Edit Banner, and SLC Family. Refer to each individual subsection for complete instructions.

9.6.1 Communication Options

9.6.1.1 Auto Test Time

To access the Auto Test Time screen:

1. Enter the installer code. The panel will automatically go to the main menu.
2. Select 7 for Panel Programming.
3. Select 5 for System Options.

4. From the next menu, select 1 for Communication Options.
5. Select 1 for Auto Test Time.
6. Enter the hour you desire the control panel to send an automatic test report (or press the up or down arrow key), then press ENTER.
7. Enter the minutes (or press the up or down arrow key), then press ENTER.
8. Select AM or PM by pressing the up or down arrow key, then press ENTER.
9. Select Report Time Interval by pressing the up or down arrow key, then press ENTER. Time Interval selections are 24hr, 12hr, 6hr and 4 hr.

Note: AM and PM are only available if the panel "Clock Options" are set for AM/PM mode. Otherwise the clock is in military time and AM/PM is not selectable.

9.6.1.2 Phone Lines

To access the phone lines screen:

1. Enter the installer code. The panel will automatically go to the main menu.
2. Select 7 for Panel Programming.
3. Select 5 for System Options.
4. From the next menu, select 1 for Communication Options.
5. Select 2 for the Phone Lines.
6. Select Phone Line to be edited (1 or 2) by pressing the up or down arrow key, then press ENTER.

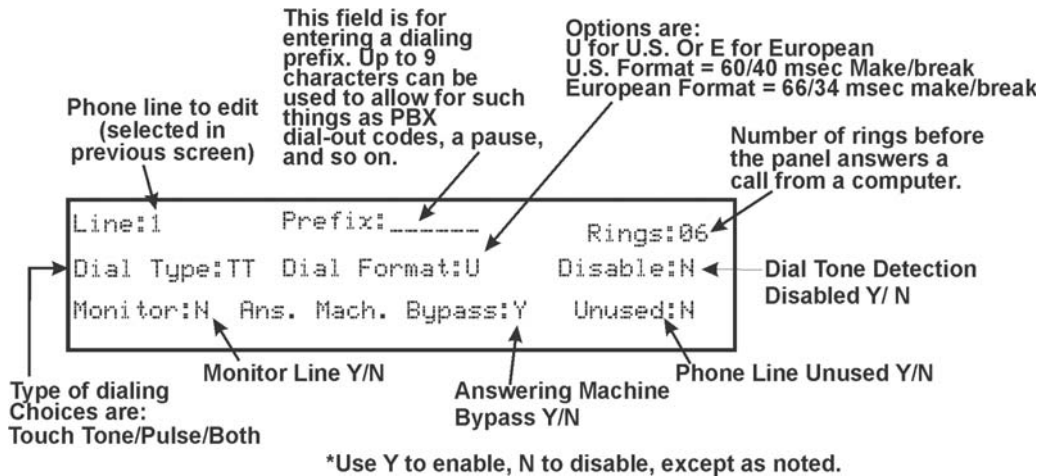

Figure 9-7 Phone Lines Editing Screen

Dialing Prefix

Enter up to 9 characters to be used for such things as PBX dial-out codes, a pause, and so on. The following special characters are available:

#	Pound (or number) key on the telephone
*	Star key on the telephone
,	Comma (character for 2-second pause)

Use the number buttons on the annunciator or the up- and down-arrow keys to select special characters. Special characters begin displaying after “9”.

7. Enter a dialing prefix (if needed), then press ENTER. Or Press the right arrow to bypass the dialing prefix option.

Number of Answer Rings

This option is used in conjunction with the HFSS Honeywell Fire Software Suite. Use this option to determine the number of rings before the panel answers a call from the computer. Range is 00-15 rings. This option is factory-programmed as 06 rings, which should be compatible for most installations where the answering machine bypass feature is used. You may need to adjust it depending on the installation’s telephone system.

The selection made here must match the programming for this option in the Communication Configuration dialog box of HFSS Honeywell Fire Software Suite.

8. Enter the desired number of answer rings, then press ENTER.

Dial Option (TouchTone or Pulse, or TT/PL)

9. Press the up or down arrow key to select the dial option, then press ENTER.

Dial Option	Description
PULSE	If this option is selected, only pulse dialing will be used for this phone line.
TT	TouchTone dialing. If this option is selected, only TouchTone dialing will be used for this phone line.
TT/PL	TouchTone alternating with pulse. If this option is selected, the communicator will first attempt to use TouchTone. It will switch to pulse if TouchTone is not successful on the first attempt. It will continue to alternate between TT and pulse for additional attempts.

Dial Format

10. Press the up or down arrow key to select the pulse ratio for rotary dialing option, then press ENTER.

Options are:

U	U.S. standard format. Uses the 60 msec / 40 msec make/break ratio.
E	European format. Uses the 66 msec / 34 msec make/break ratio.

Dial Tone Detection Disabled

11. Select Y (do disable) or N (don’t disable) by pressing the up or down arrow key, then press ENTER.

Monitor Line

Enable the line monitor for each phone line that will be used. When the phone line monitor has been enabled for a phone line, a trouble condition will occur if the line is not connected. If a phone line will not be used, it must be disabled.

12. Select Y (monitor line) or N (don’t monitor line) by pressing the up or down arrow key, then press ENTER.

Answering Machine Bypass

This option is used in conjunction with HFSS Honeywell Fire Software Suite. This feature ensures that an answering machine will not interfere with communication between the panel and the computer. If an answering machine is used at the panel site, enable this feature; if an answering machine is not used, disable the feature.

This option is factory-programmed as No (disabled).

The selection made here must match the programming for this option in the Communication Configuration dialog box of HFSS Honeywell Fire Software Suite.

13. Select Y (answering machine bypass enabled) or N (answering machine bypass disabled) by pressing the up or down arrow key, then press ENTER.

Phone Line Unused

This option is used so that you can set unused phones lines to “Yes”, so no auto-test will be sent through that line. This option is factory programmed as No.

14. Select Y or N by pressing the up or down arrow key, then press ENTER.

9.6.1.3 Edit Ethernet

1. Enter the installer code. The panel will automatically go to the main menu.
2. Select 7 for Panel Programming.
3. Select 5 for System Options.
4. From the next menu, select 1 for Communication Options.
5. Select 3 for Edit Ethernet.

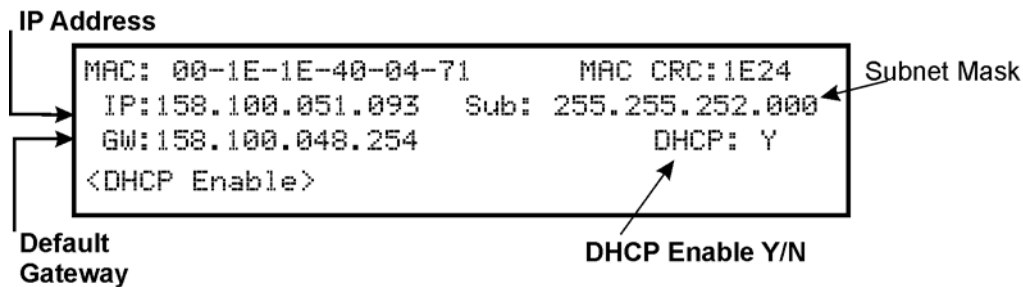

Figure 9-8 Edit Ethernet Message screen

9.6.1.4 AlarmNet Timers

1. Enter the installer code. The panel will automatically go to the main menu.
2. Select 7 for Panel Programming.
3. Select 5 for System Options.
4. From the next menu, select 1 for Communication Options.
5. Select 4 for AlarmNet Timers.
6. The available options for AlarmNet Timers are as follows: *default
 - Ethernet: None, 75 seconds, 90 seconds, 3 minutes, *5 minutes, 1 hour, 24 hours,30 days.
 - Cellular: None, *24 hours, 30 days
 - Old Alarm: None, 10 minutes, 15 Minutes,*30 Minutes, 1 Hour, 2 Hours, 4 Hours, 6 Hours, 12 Hours, 24 Hours

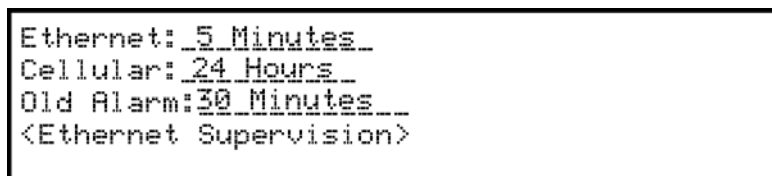

Figure 9-9 AlarmNet Timers

9.6.1.5 Phone Line Gains

1. Enter the installer code. The panel will automatically go to the main menu.
2. Select 7 for Panel Programming.
3. Select 5 for System Options.
4. From the next menu, select 1 for Communication Options.
5. Select 5 for Phone Line Gains
6. The available options: *default
 - Dialing Gain:
 - Low = 9 DB Attenuation
 - Normal = 6 DB Attenuation
 - *High = 3 DB Attenuation
 - Reporting Gain:
 - *Low = 9 DB Attenuation
 - Normal = 6 DB Attenuation
 - High = 3 DB Attenuation

9.6.2 Time Options

Through this programming option you can set the water flow delay time, alarm verification time, AC report delay, AC-Frequency, Auto-Resound, and Clock Format.

9.6.2.1 Water Flow Delay

You can program a delay of 0-90 seconds (zero means no delay) to be used in conjunction with a water flow switch. The delay is system-wide. All water flow switches on the system will use the same delay period.

To access the screen for programming water flow delay, follow these steps:

1. Enter the installer code. The panel will automatically go to the main menu.
2. Select 7 for Program Menu.
3. Select 5 for System Options.
4. Select 4 for Time Options.

A screen similar to the one shown in Figure 9-10 will display.

Water Flow Delay:01s	Alarm Verify:060s	Delay in seconds before waterflow alarm occurs. (00 - 90)
AC Report Delay:06h	AC-Frequency:60Hz	
Clock Format: AMPM	Auto-Resound: 24hr	
<Water Flow Delay (0-90s)>		

Figure 9-10 Water Flow Delay Programming Screen

5. Enter the number of seconds (0 to 90) to delay an a water flow switch alarm, then press ENTER.

9.6.2.2 Alarm Verify

You can set the alarm verification time from 60 to 250 seconds (default is 60 seconds).

To set the alarm verification:

6. Enter the desired number of seconds for the alarm verification time.
7. Press the right arrow or ENTER to make your selection and move to the next programming option.

9.6.2.3 AC Report Delay

Note: You must select 1-3 hours in UL central station installations and UL remote signaling installations.

You can adjust the number of hours before a low AC report will be sent to the central station.

To program low AC report delay, follow these steps:

8. Enter the number of hours (0-30) before a low AC report will be sent to the central station, then press ENTER.

9.6.2.4 Change AC Line Frequency

The panel's AC line frequency is selectable for 50, 60 Hz, or Internal. AC Frequency feature dictates how the control panel will calculate time based on the AC line frequency used in the installation site. The "Neither" option can be used in areas where the AC line frequency is not dependable and you want the panel to calculate time from the internal crystal. The internal crystal is not as accurate as the AC power source and internal 60 Hz or 50 Hz should normally be selected. The panel defaults to the 60 Hz. selection.

To change the AC line frequency, continue programming from step 9 above:

9. Select 50, 60 or Intl by pressing the up or down arrow, then press ENTER.

9.6.2.5 Clock Display Format (AM/PM or Military)

To change the system clock display format:

10. Select AMPM (for AM/Pm display format) or MIL (for military or 24 hr display format) by pressing the up or down arrow, then press ENTER.

9.6.2.6 Auto-Resound (4 or 24 hours)

The system resound time period can be modified from the default value 24 hours to 4 hours. This setting adjusts when the FACP will automatically resound events after being silenced. Set this option to 4 hours when using SWIFT devices

9.6.3 Miscellaneous Options

Through this programming option you can turn on or off strobe synchronization during silence and display status at idle (auto display event).

To edit miscellaneous options:

1. Enter the installer code. The panel will automatically go to the main menu.
2. Select 7 for Program Menu.
3. Select 5 for System Options.
4. Select 5 for Miscellaneous Options.

9.6.3.1 Synchronize Strobes Active During Silence

When “SYNC Strbs w/ Sil:” is Selected as Y (Yes) then strobes will continue to flash when the system is silenced and will stop flashing when the system is reset.

Note: The “SYNC Strbs w/ Sil:” only functions with outputs that use a synchronized output pattern.

5. Press the up or down arrow to toggle this selection between Y (Yes) or N (No).
6. Press the right arrow or ENTER to make your selection and move to the next programming option.

Note: See Section 9.6.3.1 for more information about Synchronization protocol choices.

9.6.3.2 Auto Display Event

When this feature is programmed Y (Yes) then the oldest un-acknowledge event will automatically display on the control panel and remote annunciators after there has been no activity on any system touchpad for two minutes.

7. Press the up or down arrow to toggle this selection between Y (Yes) or N (No).
8. Press the right arrow or ENTER to make your selection and move to the next programming option.

9.6.4 Daylight Savings Options

To edit Daylight Savings:

1. Enter the installer code. The panel will automatically go to the main menu.
2. Select 7 for Program Menu.
3. Select 5 for System Options.
4. Select 6 for Daylight Savings.

9.6.4.1 Automatic Daylight Savings Adjustment

The control panel has an automatic DST (Daylight Saving Time) adjustment feature. If this feature is not enabled (set to *No*), the Daylight Saving Time change is not made to the system clock.

To enable or disable DST adjustment continue programming:

5. Select Y (enabled) or N (disabled) by pressing the up or down arrow, then press ENTER.

9.6.4.2 Daylight Saving Time Start and End

This option lets you to adjust the week and month Daylight Saving Time (DST) starts and ends. For this feature to work, you must enable (set to *Yes*) the Automatic Daylight Savings Adjustment option under Daylight Savings Options. The default values for the DST Start and End are:

DST Start: The second Sunday in March

DST End: The first Sunday in November

To set the start and end for Daylight Saving Time:

6. Press the up or down arrow to select the week (1st, 2nd, etc.) Daylight Saving Time starts, then press ENTER to make your selection and move to the month setting.
7. Press the up or down arrow to select the month (January – December) Daylight Saving Time starts, then press ENTER to make your selection and move to the DST End option.
8. Press the up or down arrow to select the week (1st, 2nd, etc.) Daylight Saving Time ends, then press ENTER to make your selection and move to the month setting.

9. Press the up or down arrow to select the month (January – December) Daylight Saving Time ends, then press ENTER two times to make your selection and exit.

9.6.5 Edit Banner

The banner is the message that displays on the panel LCD when the system is normal, that is, when no alarms or troubles exist and the system menus are not in use. A custom message of up to 40 characters can be created.

If a customize message is not created, the system will use the internal banner. You cannot change the internal banner.

To customize the banner display message:

1. Enter the installer code. The panel will automatically go to the main menu.
2. Select 7 for Program Menu.
3. Select 5 for System Options.
4. Select 7 for Edit Banner. A screen similar to the one shown in 5. will display.

Note: See Appendix B for instructions on how to edit the banner.

5. Select each letter by pressing the up or down arrow, then press the right arrow to move to the next character.
6. When done, press ENTER to move to line two of the custom banner.

9.6.6 SLC Family

The 6820/6820EVS supports SD protocol SLC devices or SK protocol SLC devices. You must configure the 6820/6820EVS to accept the protocol of the devices you are installing. You cannot mix SLC devices of different protocols.

Note: You cannot mix SK and SD protocol SLC devices on the same panel.

1. Enter the installer code. The panel will automatically go to the main menu.
2. Select 7 for Program Menu.
3. Select 5 for System Options.
4. Press 8 for SLC Family.
5. Press Up arrow to select the desired SLC device type.
6. Press ENTER to accept the displayed SLC device type.

Note: When changing SLC type from one protocol to another, the following message will appear:

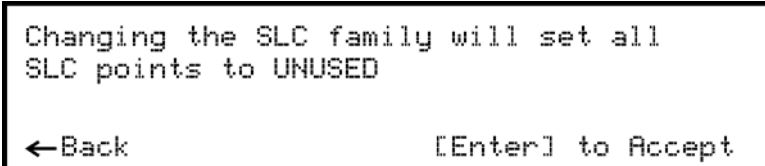

```

Changing the SLC family will set all
SLC points to UNUSED

←Back                               [Enter] to Accept

```

Figure 9-11 SLC family change

Note: Message when changing SLC family from SK to SD: Changing to this SLC family will remove all external 6815's

Note: Message when changing from SD to SK: SLC family will remove all 5815XL's on the system

9.7 JumpStart[®] AutoProgramming

Panels support an incremental JumpStart[®]. For Example: After initial JumpStart[®] & customization, if you add

more devices, when you JumpStart[®] again the additional devices are added but you do not lose any of your previous custom programming

To run JumpStart[®]:

1. Enter the installer code. The panel will automatically go to the main menu.
2. Select 7 for Panel Programming.
3. Select 6 for JumpStart[®].
4. Press ENTER to accept the warning screen.
5. Follow the remaining on screen instructions.
6. Press ENTER to confirm. See Section 8.1.3.

9.8 Restore Defaults

This option allows you to restore the panel back to factory defaults. All programming will be lost.

1. Enter the installer code. The panel will automatically go to the main menu.
2. Select 7 for Panel Programming.
3. Select 7 for Restore Defaults.
4. Press the up or down arrow key to select YES or NO from the warning screen. Then press ENTER.

9.9 VCM Maintenance

Through this programming menu you can modify the messages programmed into an VCM. You can also modify other voice settings.

9.9.1 VCM Maintenance

The VCM Maintenance menu is used to program custom messages into the VCM. Messages can be recorded locally using the microphone.

1. Select 7 for Panel Programming.
2. Select 8 for Voice Options.
3. Select 1 for VCM Maintenance.

Section 10

System Operation

Operation of the control panel is simple. Menus guide you step-by-step through operations. This section of the manual is an overview of the operation menus. Please read this entire section carefully before operating the panel.

Note: See Section 6.2.5.2 for information on how to modify user Access Codes profiles.

10.1 User and Installer Default Codes

Installer Code (factory-programmed as 123456).

Multi-site Installer Code (factory-programmed as 654321).

10.2 Annunciator Description

Figure 10-1 shows the annunciator that is part of the control panel board assembly for 6820.

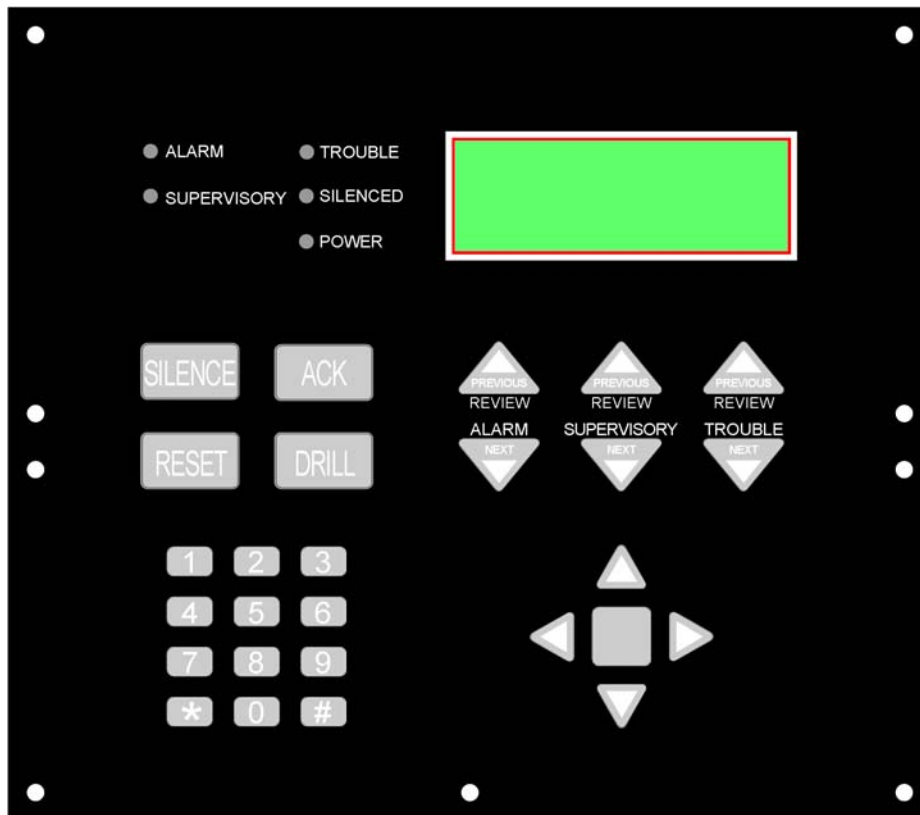

Figure 10-1 Control Panel Annunciator for 6820

Figure 10-2 shows the annunciator that is part of the control panel board assembly for the 6820EVS.

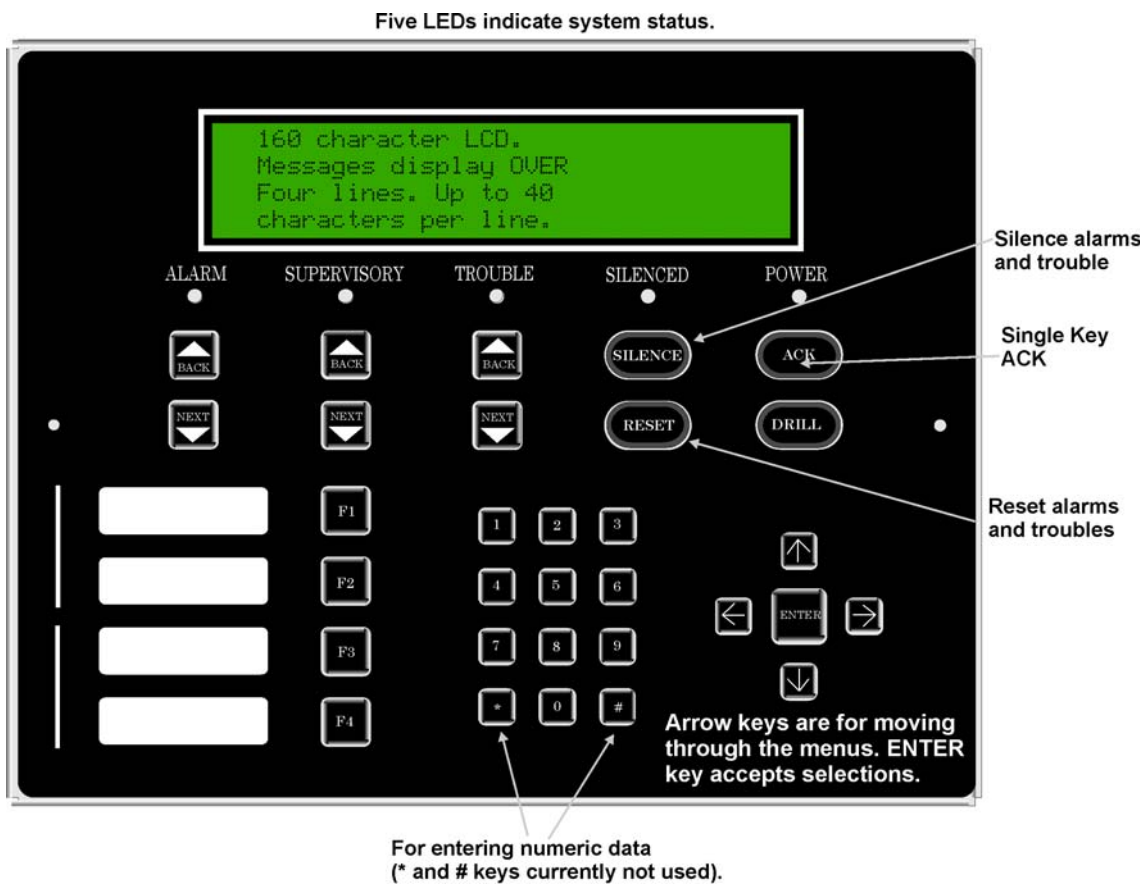

Figure 10-2 Control Panel Annunciator for 6820EVS

10.2.1 LCD Display

The control panel LCD displays system messages, annunciates alarms, supervisories and troubles, provides status information, and prompts for input. Annunciator keys beep when they are pressed.

10.2.2 Banner

The banner is the message that displays on the control panel when the system is in normal mode (no alarm or trouble condition exists and menus are not in use). A custom message can be created that will display instead of the internal (default) message. See Section 9.6.5 for information on customizing the banner.

Text of Internal Banner.

Custom Banner example.

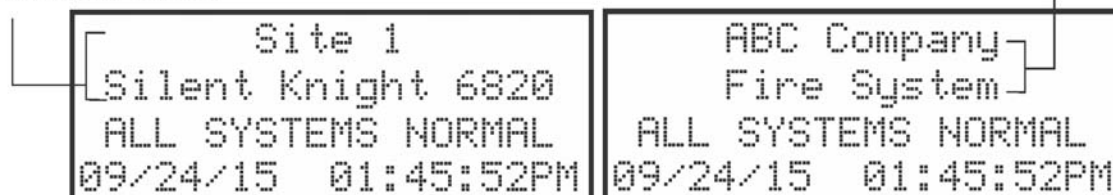

Figure 10-3 Banner Display Examples for 6820

information on editing the banner.

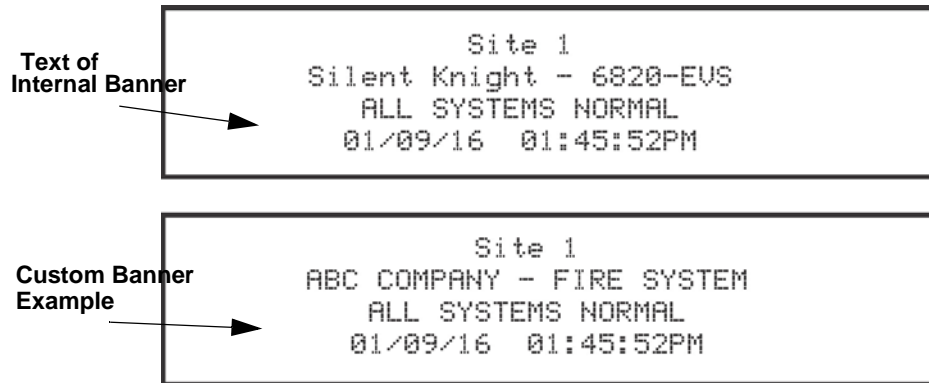

Figure 10-4 Banner Display Examples for 6820EVS

10.3 Menu System

The control panel is easy to operate from the Main Menu. To view the Main Menu press the ENTER or right arrow key on the control panel or remote annunciator. The Main Menu will appear as shown in Section 10.3.1. Select the desired option. You will be prompted for an access code if required.

The control panel supports up to 20 access codes. The profile for each access code (or user) can be modified through the network programming option (see Section 6.2.5 for access code programming).

10.3.1 Main Menu Overview

The chart below is a brief overview of the Main Menu. These options are described in greater detail throughout this section of the manual.

Main Menu Options	Description
1- System Tests	Access to Fire Drill, Indicator Test, Walk Tests, Communicator Test, Clear History Buffer, Manual AlarmNet Registration and Manual Communicator Reset.
2- Point Functions	Enable/disable points, Point Status, Set SLC Address, Device Locator, and I/O Point Control.
3- Event History	Display event history on the LCD. See Section 10.4.4 for more information.
4- Set Time & Date	Set time and date for the system.
5- Network Diagnostics	Ping Panel and Data Network Status
6- Network Programming	Access Learn Network, Edit Network Names, Edit Panel ID, Computer Access, Access Codes, Communicator Options, Voice Options, Sync Network Options.
7- Panel Programming	Brings up a set of menus for programming the panel. These options are described in detail in Section 9.
8- System Information	Menus to view information about the panel such as model, ID, serial number, revision, send or receive firmware updates and feature registration activation.

10.3.2 Using the Menus

To move through the menus:	Use the up or down arrows to move through the options in a menu. Use the left arrow to move to a previous menu.
To select an option:	Enter the number of the option, OR press ENTER if the option has the = symbol next to it.
Exit Menu	Left arrow

10.4 Basic Operation

10.4.1 Setting Time and Date

1. Select 4 for Set Date & Time.
2. Make changes in the fields on the screen. Use right arrow to move through the fields. Use the up or down arrow key to select options in the fields.
3. When the date and time are correct, press ENTER.

10.4.2 Disable / Enable a Point

1. Select 2 for Point Functions.
2. Select 1 for Disable/Enable Point.

10.4.2.1 Disable / Enable NACs by Template

1. Press 1 for Disable NACs by Template, press 2 to Enable NACs by Template.
2. Use the up or down arrow key to move through the list of templates. Press ENTER to select the current template.

10.4.2.2 Disable / Enable NACs by Group

1. Press 3 to Disable NACs by Group, or press 4 to Enable NACs by Group.
2. Use the up or down arrow key to move through the list of groups. Press ENTER to select the group highlighted.

10.4.2.3 Disable / Enable Zone Points

1. Press 5 to Disable Zone Points, or press 6 to Enable Zone Points.
2. Use the up or down arrow key to move through the list of zones. Press ENTER to select the zone highlighted.

10.4.2.4 Disable / Enable Point

1. Press 7 to Disable /Enable Point.
2. Choose Module.
3. Use the up or down arrow key to choose point and press ENTER.
4. Press right arrow to disable or enable point.

10.4.2.5 Inhibit Output Group

Inhibiting an output group prevents the group from being utilized by system mapping. While inhibited no event in the system can activate the output group.

1. Press 8 to inhibit output group.
2. Use the up or down arrow key to select the group to be inhibited.
3. Press right arrow to inhibit the group.
4. Press right arrow again to enable the group.

10.4.3 View Event History

Use the View Event History feature to display events on LCD. From the Main Menu, press 3 to select Event History. Events will begin displaying with most recent events first.

The panel can store up to 1000 events. When it reaches its 1000-event capacity, it will delete the oldest events to make room for the new events as they occur. In networked setups, each panel stores up to 1000 of its own events. When using HFSS Honeywell Fire Software Suite, all 1000 events from every panel in the network will be uploaded.

On multi-site displays, pressing ENTER or right arrow brings you directly into View Event History and allows you to view the Event History from every panel in each of the sites that the multi-site display is assigned to.

10.4.3.1 To clear the event history

From the Installer menu select 1 for System Tests. From the test menu select 6 Clear History Buffer.

10.4.3.2 Single Key Acknowledge

This feature allows the user to press the ACK and display the oldest un-acknowledged event in the system. Pressing ACK again will acknowledge the event, then display the next oldest un-acknowledged event without pressing the arrow keys.

10.4.4 Conduct a Fire Drill

This system test initiates a Fire Drill alarm and activates Fire Drill mapping for 10 minutes or until a user manually exits the fire drill.

1. From the Main Menu, press 1 for System Tests.
2. Press 1 for Fire Drill. You will be prompted to press ENTER.
3. The drill will begin immediately after you press ENTER.
4. Press any key to end the drill. (If you do not press any key to end the fire drill manually, it will time out automatically after ten minutes.)

If a fire drill switch has been installed, activating the switch will begin the drill; deactivating the switch will end the drill.

10.4.5 Conduct an Indicator Test

The indicator test checks the annunciator LEDs, PZT, and LCD display.

1. From the Main Menu, press 1 for System Tests.

- Press 2 for Indicator Test. The system turns on each LED several times, beeping the PZT as it does so. At the same time it scrolls each available character across the LCD. A problem is indicated if any of the following occurs:

- An LED does not turn on.
- You do not hear a beep.
- All four lines of the LCD are not full.

This test will run for approximately 15 minutes or until the user manually exits. You can press any key to end manually while the test is still in progress. When the test ends, you will be returned to the <Test Menu>.

10.4.6 Conduct a Walk Test

Walk Test is a feature which allows one person to test the fire alarm system. The Walk Test will run for 4 hours or until the user manually exits. If an alarm or pre-alarm condition is occurring in the system, you will not be able to enter the walk test. A walk test may only be initiated if the test is enabled in the user profile.

- From the Main Menu, press 1 for System Tests.

IMPORTANT!

If any alarm verification zones are being used, the user will be asked if they wish to disable alarm verification during walk test. This occurs for either walk test option.

- Select 3 for Walk Test-No Rpt. Enter the time period you wish the NAC circuit to be active for each alarm (06 to 180 seconds). The LCD will display “WALK TEST STOPPED” on Line 1 and “ENTER = start test” on Line 3. By selecting this option, central station reporting is disabled while the test is in progress.

Select 4 for Walk Test-with Rpt. Enter the time period you wish the NAC circuit to be active for each alarm (06 to 180 seconds). The LCD will display “WALK TEST STOPPED” on Line 1 and “ENTER = start test” on Line 3. By selecting this option, central station reporting will occur as normal during the walk test.

The panel generates a TEST report to the central station when the walk test begins. During a walk test, the panel’s normal fire alarm function is completely disabled, placing the panel in a local trouble condition. All zones respond as 1-Count zones (respond when a single detector is in alarm) during a walk test. Each alarm initiated during the walk test will be reported and stored in the event history buffer.

- To End the Walk test, go to the main menu. Select 1 for System Test, then press 3 or 4. Press ENTER to end the walk test. The system will reset. The panel will send a “TEST RESTORE” report to the central station.

If you do not end the walk test manually within four hours, it will end automatically. If an alarm or pre-alarm condition is occurring in the system, you will not be able to enter the walk test.

Note: The panel does not do a full 30 second reset on resettable power outputs. As soon as the device is back to normal, the panel is ready to go to the next device.

10.4.7 Conduct a Communicator Test

- From the Main Menu, press 1 for System Tests.
- Select 5 for Communicator Test. The screen will display “Manual Communicator Test started”. When the test is completed, you will be returned to the <Test Menu>. A manual communicator test requires that at least one daily test in the network be enabled in communicator programming.
- The Manual communicator test will be communicated out both Phone Lines and Ethernet/Cellular paths if they are all programmed. Each manual communicator test will alternate between one of the Phone Line paths and one of the AlarmNet paths.

10.4.8 Manual AlarmNet Registration

1. From the Main Menu, press 1 for System Tests.
2. Select 8 for Register AlarmNet. The screen will display and ask for confirmation. Feedback will be given if the command was sent or not.

10.4.9 Silence Alarms or Troubles

Press SILENCE to turn off silenceable outputs and annunciator PZTs. If an external silence switch has been installed, activating the switch will silence alarms or troubles. If you are already using system menus when you press SILENCE, you will not need to enter your code.

Note: Alarm and trouble signals that have been silenced, but the detector remains un-restored, will un-silence every 4 or 24 hours depending on user selection (see section 9.6.2.6) until the detector is restored.

Note: Multi-Site displays do not allow for silencing multiple sites. Pressing SILENCE will only locally silence the PZT built into the annunciator.

Note: For EVS systems, pressing silence at an LOC will only silence the System in Control. See Section 10.5.1.

10.4.10 Reset Alarms

Press RESET to perform a control panel reset. If an external reset switch has been installed, activating the switch will reset fire alarms.

Note: Multi-Site displays do not allow for resetting multiple sites.

Note: For EVS systems, pressing reset at an LOC will prompt the user for which system they desire to reset. See Section 10.5.1.

10.4.10.1 Reset Communicator

This options allows the user to Reset the communicator. The LCD will display:

“Resetting Communicator... Please Wait“

You will be returned to the Main Menu when the reset is complete.

The communicator is not allowed to be reset when alarms or supervisories are active. Communicator reset is not allowed if any of the following are active:

- Fire Alarm
- Fire Supervisory
- Fire Pre-Alarm
- CO Alarm
- CO Supervisory
- EVS Alarm
- EVS Supervisory

10.4.11 Check Detector Sensitivity Through Point Status

The control panel constantly monitors smoke detectors to ensure that sensitivity levels are in compliance with NFPA 72. Detectors are sampled every three hours.

If sensitivity for a detector is not in compliance, the panel goes into trouble, generating a Calibration Trouble condition. A detector enters a Calibration Maintenance state to indicate that it is approaching an out of compliance condition (but is currently still in compliance).

When a Calibration Trouble condition occurs, the central station receives a detector trouble report (“373” + Zone

for Contact ID format; "FT" + Zone # in SIA format).

To check sensitivity for an individual detector, follow the steps below.

1. From the Main Menu, press 2 for Point Functions.
2. Press 2 for Point Status.
3. Select the module where the point you want to check is located.
4. Enter the number of the point you want to check and press ENTER.

A screen similar to those shown in Figure 10-5 will display for 6820 and Figure 10-6 for 6820EVS.

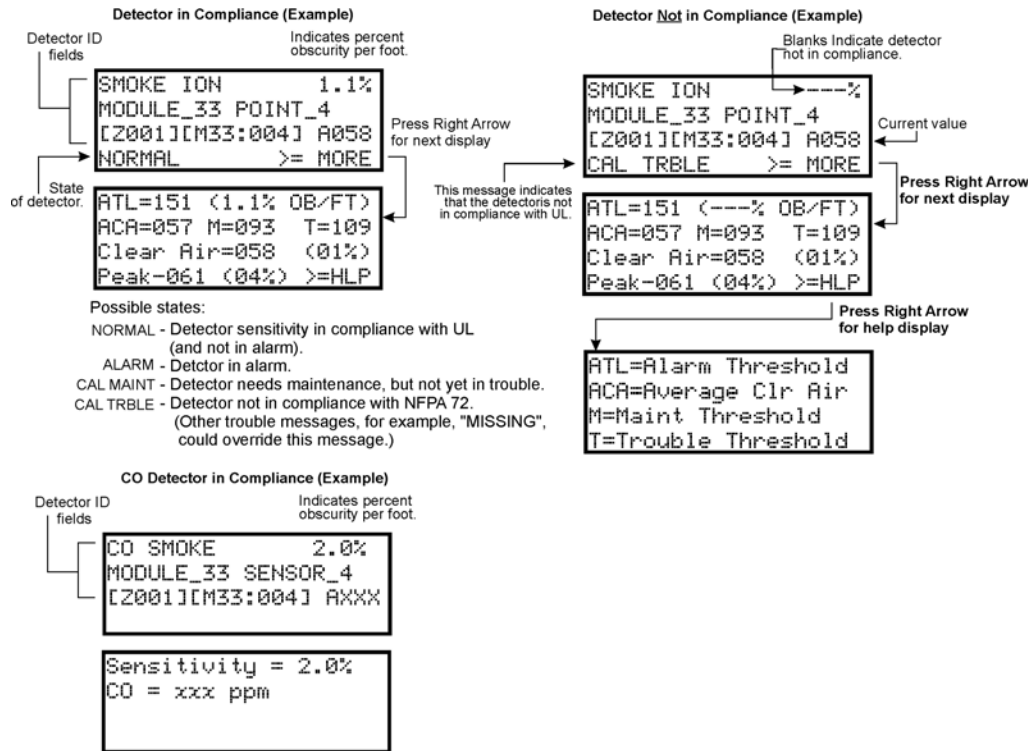

Figure 10-5 Checking Detector Sensitivity Compliance 6820 4x20 display

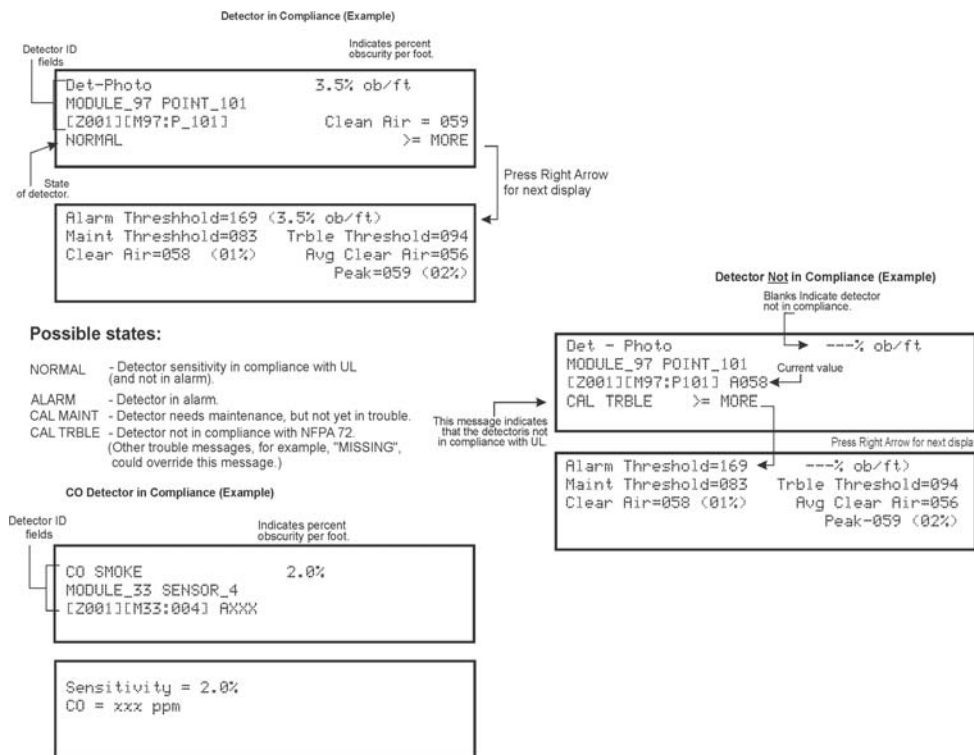

Figure 10-6 Checking Detector Sensitivity Compliance 6820EVS 4x 40 display

You can print detector status by uploading the detector status to and printing from HFSS Honeywell Fire Software Suite.

10.4.12 View Status of a Point

1. From the Main Menu, select 2 for Point Status.
2. From the list that displays, press ENTER to select the module where this point is located. Next, enter the point to display. The screen that displays will show you if the point has a trouble and will provide sensitivity compliance information. (See Section 10.4.11 for complete information about detector sensitivity compliance.)

10.4.13 View Alarms or Troubles

When the system is in alarm or trouble, you can press down arrow to view the location of an alarm or trouble.

10.4.14 System Information

Press 8 from the Main Menu to view the panel model and serial number and system version number and date. Press the left arrow to return to the main menu.

About Panel

Press 1 to access About Panel to view the panel model, serial number and system version number and date.

Send/Receive firmware updates

The 6820 or 6820EVS has the ability to be updated in the field. The latest 6820 or 6820EVS Firmware Update Utility can be downloaded from www.silentknight.com. Once a panel has been updated using the Firmware

Update Utility, you can use Send/Receive firmware updates to propagate the firmware to the other panels in the network.

1. Press 2 to send a firmware update or press 3 to receive a firmware update from the System Information menu. Available panels are listed in the menu.
2. Use the up or down arrow key to select a panel to send/receive an update to/from. Press ENTER to start the update process.

Ethernet Info

1. Press 5 from the System Information menu for Ethernet Information.

```

>Ethernet Info>
MAC Address 00-D0-2D-20-68-94 MAC CRC0000
IP:000.000.000.000   Sub: 000.000.000.000
GW:000.000.000.000   DHCP: Y

```

AlarmNet Info

1. Press 6 from the System Information menu for AlarmNet Info
2. Cell Strength: 0 to 100%
3. Status: Registered/Not Registered

AlarmNet Temporary PIN

Press 7 from the System Information menu for AlarmNet Temporary PIN. This is used in case the FACP is replaced on the CCP.

10.5 Event Priority

This section goes over how event activations are handled by the control panel with regards to priority.

10.5.1 System Control

The 6820 or 6820EVS control panel integrates both a fire and emergency system into one. When events are active from both systems the control panel makes intelligent decisions to determine which system should be controlling outputs. This is called System Control. This manual will refer to the fire or emergency systems having System Control, this means that the system has an active alarm or supervisory event that has a higher event priority than an active alarm or supervisory event from the other system. For this consideration, the control panel looks at the highest priority event active on each system. When both systems are active, the system with control will activate System Override. System Override is activated on the lower priority, non-System Control panel system (fire or emergency system.)

10.5.2 System Override

System Override temporarily disengages output group activations from the system being overridden. This is done to not provide conflicting messages and signaling and help with reducing confusion of the building occupants.

When output groups are supposed to be active but are not because System Control has activated System Override, they are re-activated every 30 seconds for 2-3 seconds to indicate to the building occupants that there is

still an event active. This will only occur when the system with System Control is not using the output group. The System Override option is programmable for non-voice output groups on a per output group basis through the panel output group programming menus and in HFSS Honeywell Fire Software Suite. In these places the option is called Allow System Override and defaults to YES. It is also possible to not reactivate the output groups every 30 seconds when System Override is active on a per system basis. This option is programmable in HFSS Honeywell Fire Software Suite.

There are times when you would not want to allow System Override for an output group. For example: fire is programmed to an elevator relay to bring the elevator to the bottom floor for fire only. If fire and EVS are active with EVS being the higher priority event, you still need the elevator to move to the bottom floor and only audible and visual notification appliances must be overridden. In this case, the output group assigned to the relay would be set to NO on the Allow System Override setting. See Section 9.4.1.2 to edit group properties.

10.5.3 Event Priority

Each event type (see Table 10-1) has a priority level assigned to it. When more than one event type is active, the panel uses the Event Priority Table to determine which event mapping to use to control output groups. The Event Priority Table can be modified using HFSS Honeywell Fire Software Suite. It is strongly recommended that before each installation a risk analysis is done by the stake holders (property owners, AHJ, occupants, etc.) to determine which events take precedence over others.

The Emergency LOC Alarm entry in the Event Priority Table encompasses all EVS Alarm Events that can be activated from an LOC (LOC Mic Triggered EVS Alarm and LOC EVS 1 Alarm through LOC EVS 8 Alarm). By default, these events do not have a priority - they can be activated in any order. A programming option in HFSS Honeywell Fire Software Suite exists to force a priority scheme for the LOC EVS Alarm Events. When this option is enabled, the lower numbered the EVS event is, the higher priority it has (e.g. LOC EVS 1 Alarm is higher priority than LOC EVS 8 Alarm). With this priority scheme, once a higher priority EVS Event has been activated, an EVS reset must be performed before a lower priority EVS Event can be activated.

The Event Priority Table contains the following events for modification:

Table 10-1: Event Priority Table

Fire System	Emergency System
Fire Manual Pull Alarm	Emergency LOC Alarm
Fire Detector Alarm	Emergency 1 Point Alarm
Fire Water Flow Alarm	Emergency 2 Point Alarm
Fire Interlock Release Alarm	Emergency 3 Point Alarm
Fire Zone Aux 1 Alarm	Emergency 4 Point Alarm
Fire Zone Aux 2 Alarm	Emergency 5 Point Alarm
Fire System Aux 1 Alarm	Emergency 6 Point Alarm
Fire System Aux 2 Alarm	Emergency 7 Point Alarm
	Emergency 8 Point Alarm
	Emergency Voice Aux 1 Alarm
	Emergency Voice Aux 2 Alarm
	Emergency Voice Aux 3 Alarm
	Emergency Voice Aux 4 Alarm
CO Alarm	
Fire Pre-Alarm	
Fire Interlock Alert	
	Emergency Supervisory
Fire Supervisory	

Table 10-1: Event Priority Table

CO Supervisory	
Trouble	
Site F Key Status	
System Status	

Note: Status Points, Status Voice Aux 1, Status Voice Aux 2, and Background Music are contained within the System Status event priority.

Note: All fire, emergency and system troubles are prioritized into the Trouble event priority.

10.5.4 Priority Rules

1. Event priorities can be changed only within, not between, priority levels (defined by bold lines in Table 10-1).
2. Emergency LOC Alarm must always higher than Emergency 1-8 Point Alarm and Emergency Voice Aux 1-4 Alarm.
3. EVS events do not need to be in order by EVS number.

10.5.5 Other Priority Considerations

There are other considerations to take into account when the same event is acting on the same output group (an event being mapped to an output group.) These are prioritized in order of appearance:

- Event priority is considered here based on the Event Priority Table.
- If an output group is mapped both directly and through an output group template to an event, the direct map gets priority. Example: Template 1 Contains Group 1. Zone 1 Manual Pull is mapped to Template 1 and Group 1 using constant and ANSI patterns respectively. If Zone 1 Manual Pull is active, Group 1 will output ANSI.
- When an event is mapped to an output group from multiple zones, the lower numbered zone gets priority. Example: Zone 1 Manual Pull and Zone 2 Manual Pull are mapped to Group 1 using constant and ANSI patterns respectively. If Zone 1 and Zone 2 Manual Pull events are active, Group 1 will output constant.

10.6 Operation Mode Behavior

The control panel can be in one or more of seven conditions at any given moment: Normal, Alarm, Prealarm, Supervisory, Trouble, Silenced, and Reset. Table 10-2 describes the behavior of the panel in each of these modes.

When looking at the LCD, the screen will display FIRE for the “Fire System”, CO for the “CO System” and EMGY for “Emergency Communication System”. The highest priority event will display first and include the event count.

Press the down arrow to view the location and type of alarm, supervisory, or trouble. If the panel is programmed to Auto Display Event, information describing the highest priority active event will display on the first two lines. The 3 and 4th line will show the status of which event types are active for each system (fire, CO and emergency

systems). Auto Display Event activates after two minutes of annunciator inactivity.

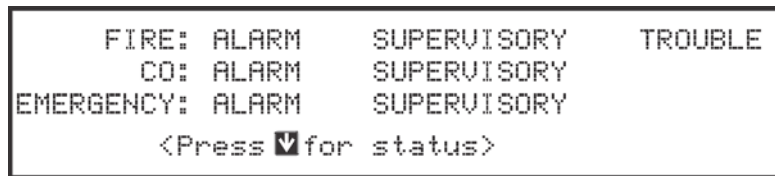

Figure 10-7 Highest Priority Event Display



Figure 10-8 Event Display after Two Minutes Sitting idle

Table 10-2: Operation Mode Behavior

Operation Mode	Occurs When	System Behavior	In This Mode You Can
Normal	No alarm or trouble condition exists and menus are not in use.	SYSTEM POWER LED is on. The All Systems Normal display indicates that the system is in normal mode. The current date and time display on the last line of the LCD.	Enter the appropriate code to activate the User or Installer Menu, or rotate the key to activate the User Menu.
Alarm	A smoke detector goes into alarm or a pull station is activated. EVS LOC or point alarm CO Detector goes into Alarm. If more than 3 categories are active at a single time.	The communicator seizes control of the phone line and calls the central station. The on-board annunciator sounds a loud, steady beep (any notification devices attached to the system will also sound). GENERAL ALARM LED flashes. The LCD displays a screen similar to this one.   Press the down arrow to view the type and location of alarm. (Message alternates with the date/time display) 	Press the down arrow to view the alarm. A screen similar to this one displays.  Press SILENCE and enter an access code (or activate the key) to silence the annunciator (and any notification devices attached to the system). When the alarm condition clears, press RESET and enter a code (or activate the key) to restore the panel to normal.

Table 10-2: Operation Mode Behavior



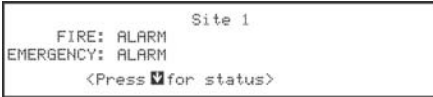
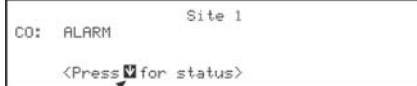
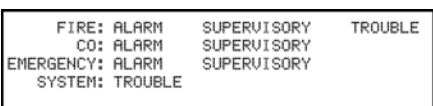
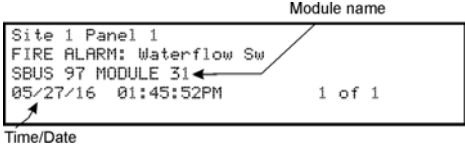

Operation Mode	Occurs When	System Behavior	In This Mode You Can
Supervisory	<p>The system detects a supervisory condition.</p> <p>The system detects a supervisory condition with a CO detector.</p>	<p>The communicator seizes control of the phone line and calls the central station.</p> <p>The on-board annunciator sounds a loud, pulsing beep in the sequence one second on, one second off.</p> <p>SUPERVISORY LED flashes.</p> <p>The LCD displays a screen similar to this one.</p> <div data-bbox="496 562 906 655" style="border: 1px solid black; padding: 5px; margin: 10px 0;"> <p style="text-align: right;">Site 1</p> <p>FIRE: SUPERVISORY</p> <p><Press  for status></p> </div> <div data-bbox="487 743 906 835" style="border: 1px solid black; padding: 5px; margin: 10px 0;"> <p style="text-align: right;">Site 1</p> <p>CO: SUPERVISORY</p> <p><Press  for status></p> </div>	<p>Press down arrow to view the supervisory condition. A screen similar to this one displays.</p> <div data-bbox="967 386 1399 504" style="border: 1px solid black; padding: 5px; margin: 10px 0;"> <p style="text-align: right;">Device type</p> <p>Site 1 Panel 1 FIRE SUPERVISORY: Supervisory Sw SBUS 97 MODULE 32 6/17/16 12:54:10PM 1 of 1</p> </div> <p>Press SILENCE and enter an access code (or activate the key) to silence the annunciator.</p> <p>Once the supervisory condition has been corrected, the system will restore itself automatically.</p>
Trouble	<p>A system trouble condition occurs.</p> <p>A trouble condition with a CO detector.</p>	<p>The communicator seizes control of the phone line and calls the central station.</p> <p>The on-board annunciator sounds a loud, pulsing beep in the sequence one second on, nine seconds off.</p> <p>SYSTEM TROUBLE LED flashes.</p> <p>The LCD displays a screen similar to this one.</p> <div data-bbox="480 1129 915 1222" style="border: 1px solid black; padding: 5px; margin: 10px 0;"> <p style="text-align: right;">Site 1</p> <p>FIRE: TROUBLE</p> <p><Press  for status></p> </div> <p style="text-align: center; margin: 5px 0;">Press the down arrow to view the type and location of fire trouble condition. (This message alternates with the date / time display.)</p> <div data-bbox="480 1352 915 1444" style="border: 1px solid black; padding: 5px; margin: 10px 0;"> <p style="text-align: right;">Site 1</p> <p>CO: TROUBLE</p> <p><Press  for status></p> </div> <p style="text-align: center; margin: 5px 0;">Press the down arrow to view the type and location of fire trouble condition. (This message alternates with the date / time display.)</p>	<p>Press down arrow to view the trouble. A screen similar to this one displays.</p> <div data-bbox="971 1003 1406 1096" style="border: 1px solid black; padding: 5px; margin: 10px 0;"> <p>Site 1 Panel 1 FIRE TROUBLE: Supervisory Sw SBUS 97 MODULE 32 06/17/16 01:16:15PM</p> </div> <p>Press SILENCE and enter an access code (or activate the key) to silence the annunciator.</p> <p>Once the trouble condition has been fixed, the system will restore itself automatically.</p>
Prealarm	<p>A single detector trips in a 2-Count zone. (2-Count means two detectors must trip before an alarm is reported.)</p>	<p>Touchpad PZT beeps.</p> <p>The LCD displays a screen similar to this one.</p> <div data-bbox="480 1646 915 1738" style="border: 1px solid black; padding: 5px; margin: 10px 0;"> <p style="text-align: right;">Site 1</p> <p>FIRE: PREALARM</p> <p><Press  for status></p> </div> <p style="text-align: center; margin: 5px 0;">Press the down arrow to view the type and location of prealarm. (This message alternates with the date / time display.)</p>	<p>Press down arrow to view the Prealarm. A screen similar to this one displays.</p> <div data-bbox="967 1646 1399 1738" style="border: 1px solid black; padding: 5px; margin: 10px 0;"> <p>Site 1 Panel 2 FIRE PREALARM: Det-Photo SBUS_97 SENSOR_33 06/13/16 12:54:10PM 1 of 1</p> </div> <p>All system operations are available in this mode.</p>

Table 10-2: Operation Mode Behavior

Operation Mode	Occurs When	System Behavior	In This Mode You Can
Reset	The RESET button is pressed followed by a valid code or rotation of the key.	All LEDs are on briefly then the LCD displays "RESET IN PROGRESS". If the reset process completes normally, the date and time normal mode screen displays.	Menus are not available during the reset process.
Silenced	An alarm or trouble condition has been silenced but still exists. To silence alarms and troubles, press SILENCE followed by the Installer or User Code or rotate the key.	SYSTEM SILENCE LED is on. SYSTEM TROUBLE, SUPERVISORY or GENERAL ALARM LED (depending on condition) is on. The annunciator (and any notification devices attached to the system) will be silenced.	Press down arrow to view the location of the alarm or trouble. When the condition no longer exists, the SYSTEM SILENCED and SYSTEM TROUBLE LED, SUPERVISORY or GENERAL ALARM LEDs turn off.

10.6.1 Multi-Site Annunciator and Multi-Site User Access

Multi-site Annunciators are unique as they can display the status and event history of all sites they are assigned to. These displays can be especially useful in guard shacks or security centers. A multi-site display is indicated by the words "Multi-Site Display" at the top of the idle screen.

1. The F-Macro key is disabled until a multi-site user access code has been entered and a specific site has been selected.
2. Multi-site Annunciator silencing rules:
 - If any new troubles, supervisory, pre-alarms, or alarms are triggered in any assigned sites, Locally Silenced annunciator will resound.
 - If a multi-site annunciator is locally silenced for 4 or 24 hours depending on user selection (see section 9.6.2.6), the locally silenced annunciator will resound.
3. The 6820 or 6820EVS menu system is disabled on a multi-site annunciator. Pressing the Right or Enter keys will bring you straight into event history for assigned sites. To get into the menu system, a multi-site user password must be entered and then a site must be selected from the site selection menu. Once this is done you will have access to the idle screen of that site and the annunciator will temporarily act like a single site annunciator.
4. A multi-site annunciator will sound the highest priority tone from the sites it is assigned to.

Note: A multi-site display is created in Module programming in the edit properties menu for an 6860, 5860 or 6855 See section 9.2.1.

Note: An annunciator cannot be programmed as a multi-site display when it is associated with an VCM or RVM in a EVS system.

Note: Status Points, Status Voice Aux 1, Status Voice Aux 2, and Background Music are contained within the System Status event priority.

Note: All fire, emergency and system troubles are prioritized into the Trouble event priority.

10.7 Releasing Operations

The control panel supports two types of releasing: Double Interlock Zone, and Single Interlock Zone. The Double Interlock Zone operation requires an interlock switch input in the system, and the Single Interlock Zone does not. An interlock switch is typically a dry-contact pressure switch.

When Single or Double Interlock Zone releasing is selected using HFSS Honeywell Fire Software Suite software, the software suite will automatically default the following system parameters:

Note: The defaults created can be modified through programming if desired.

- Output Group 2 is created. Output Group 2 will be defaulted as a “Detector Alarm” output group for all releasing zones. NAC [98:001] is assigned to Output Group 2.
- Output Group 3 is created. Output Group 3 will be defaulted as a “Interlock Release Alert” output group for all releasing zones. NAC [98:002] is assigned to Output Group 3.
- Output Group 4 is created. Output Group 4 will be defaulted as “Interlock Release Alarm” output group for all releasing zones. NAC circuit [98:003] is assigned to Output Group 4.

Note: The installer must define which input points will be used for detectors, manual release switches, or interlock/pressure switches.

Note: For manual release operation, Installer must use an FM approved/ UL listed releasing manual station.

Table 10-3: Approved Releasing Solenoids

Manufacturer	Part Number	Rated Voltage, DC	Rated Current, Milliamp
Asco	T8210A107	24 VDC	700
	8210G207	24 VDC	442
	HV2740607	24 VDC	375
	HV2838521	24 VDC	375
	HV2740608	24 VDC	375
Honeywell/Skinner	701X7028	24 VDC	917
Barnbrook System	EA45	24 VDC	200
Kidde Fenwal	890181	24 VDC	2000
	486500	24 VDC	290
	895630	24 VDC	2000
	897494	24 VDC	1500
Minimax	88 7363	24 VDC	1040
	88 5738	24 VDC	1040
	88 9323	24 VDC	500
Nohmi Bosai	R85M10	24 VDC	1200
Parker Hannifin	70610006	24 VDC	417
	10610707	24 VDC	417
Snap-tite	2823A-2NB-A4F6	24 VDC	458
	2823A-2NB-A4F5	12 VDC	917
TLX	PA0036-A	24 VDC	600
Versa Valves	CGS-4232-NB3-S2	24 VDC	438
Victaulic	753E	24 VDC	364
	767	24 VDC	364

Table 10-3: Approved Releasing Solenoids

Manufacturer	Part Number	Rated Voltage, DC	Rated Current, Milliamp
Viking	11591	24 VDC	417
	11595	24 VDC	417
	11592NC	24 VDC	416
	16360	24 VDC	500

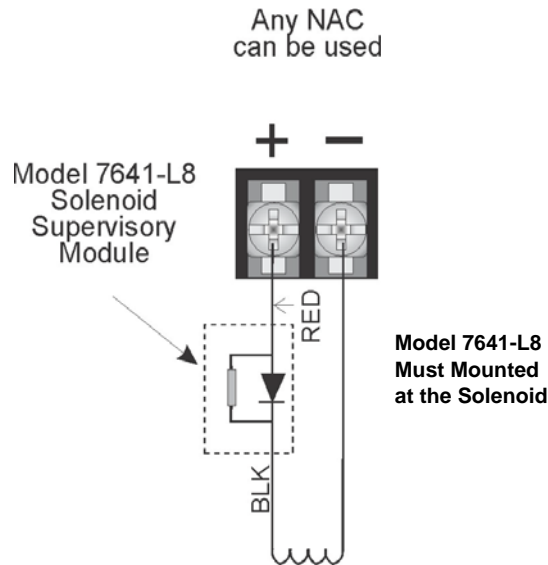

Figure 10-9 Wiring Configuration for Solenoid

* When ordering, order as P/N 7641-L8

10.7.1 Single Interlock Zone Releasing

A single interlock zone utilizes a minimum of two addressable detectors and a designated manual release switch.

Important!
Only addressable detectors can be used. No conventional detectors can be used.
Each Single Interlock Zone input requires at least one manual release switch.

Conditions Required for an Pre-Alarm Output Activation

If any single addressable detector is activated, the “Pre-Alarm” output will activate. This alerts the user that the initial stages required for a release condition are present. (Also refer to Table 10-4.)

Conditions required for an General Alarm and Release Output Activation

If two or more addressable detectors, or a manual release switch activate, the “Alarm” and the “Release” outputs

will activate and the “Pre-Alarm” output will deactivate. (Also refer to Table 10-4.)

Table 10-4: Single Interlock Zone Operation

Inputs	Output Results							
1st Addressable Detector		x		x		x		x
2nd Addressable Detector			x	x			x	x
Manual Release Station					x	x	x	x
	Normal	Pre-Alarm	Pre-Alarm	Release and General Alarm	Release and General Alarm	Release and General Alarm	Release and General Alarm	Release and General Alarm

10.7.2 Double Interlock Zone Releasing

A Double Interlock Zone uses a minimum of two addressable detectors, a designated manual release switch, and an interlock switch input. An interlock switch is typically a dry-contact pressure switch and will be referred to as an interlock/pressure switch in this document.

Important!
Only addressable detectors can be used. No conventional detectors can be used.
Each Double Interlock Zone input requires at least one Interlock/pressure switch and at least one manual release switch.

Conditions Required for a Pre-Alarm Output Activation

If any single addressable detector is activated, the “Pre-Alarm” output will activate. This alerts the user that the initial stages required for a release condition are present. (Also refer to Table 10-4.)

Conditions Required for a General Alarm Output Activation

If two addressable detectors, a manual release switch is activated, or an interlock switch is active, the “Pre-Alarm”, and “General Alarm” outputs will activate.

Conditions Required for a Release Output Activation

Any release requires the activation of an interlock switch, and either a manual release switch or 2 activated addressable detectors. When these conditions are met, the “Release” and “General Alarm” outputs will activate,

and the “Pre-Alarm” output will deactivate.

Table 10-5: Double Interlock Zone Operation

Inputs	Output Results																
	1	2	3	4	5	6	7	8	9	10	11	12	13	14	15		
1st Addressable Detector	x		x		x		x		x		x		x		x		
2nd Addressable Detector		x	x			x	x			x	x			x	x		
Manual Release Station				x	x	x	x					x	x	x	x		
Interlock/Pressure Switch								x	x	x	x	x	x	x	x		
	Normal	Pre-Alarm	Pre-Alarm	Pre-Alarm and General Alarm	Pre-Alarm and General Alarm	Pre-Alarm and General Alarm	Pre-Alarm and General Alarm	Pre-Alarm and General Alarm	Pre-Alarm and General Alarm	Pre-Alarm and General Alarm	Pre-Alarm and General Alarm	Pre-Alarm and General Alarm	Release and General Alarm	Release and General Alarm	Release and General Alarm	Release and General Alarm	Release and General Alarm

10.8 Smoke Alarm Verification

Figure 10-10 illustrates how the Smoke Alarm Verification cycle operates.

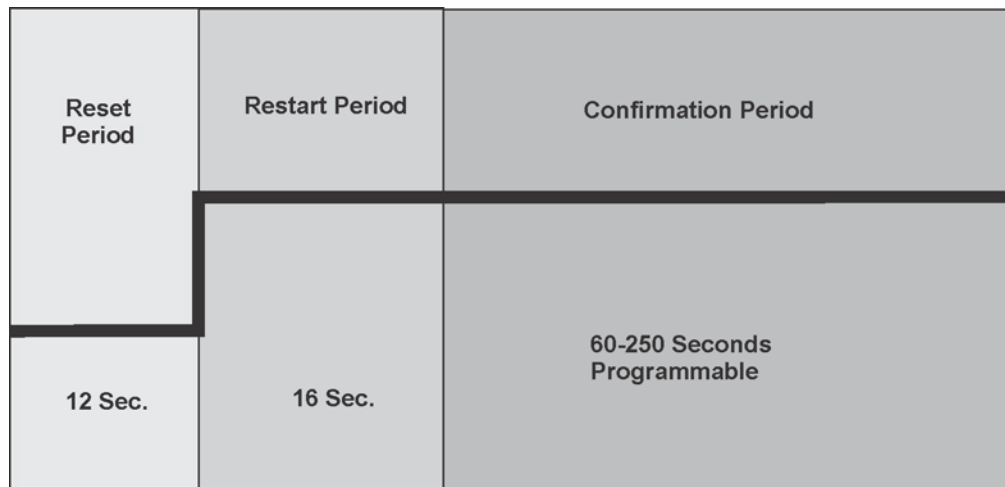

Figure 10-10 Smoke Verification Cycle

During the Confirmation Period if there is no alarm indication then the system will return to normal operation.

10.9 Function Keys

The function keys (on the 6860 only) have multiple features. Their macro key functionality can simplify the disabling, activating, or inhibiting points or groups respectively. They can also be used as a status type activation event and for activating Map Inhibit. Each F-Key macro can hold 50 events.

To access the F-Key Recording menu:

1. From the idle screen, press and hold the F-Key for 5 seconds.
2. Enter a PIN with F-Key macro recording privileges, if prompted.

10.9.1 Recording an F-Key Macro

1. Access the F-Key Recording menu and select the 'Start F-KEY Recording' option.
2. The panel will return to the idle screen. Notice the 4th line on the display now alternates with <F# Key Recording>, where # is the number of the F-Key being recorded.
3. Any Disabling or Activating of points, output groups, or templates from the site at this point will be programmed into the macro. Do this by going to any annunciator within the site and entering Main Menu -> Point Functions and use Disable/Enable Point or use I/O Point Control to: disable output groups or individual points, or activate individual points.
4. Once you are finished with disabling or activating points/output groups, enter the F-Key Recording Menu again and select the 'End F-KEY Recording' option.
5. The panel will return to the idle screen.

10.9.2 Aborting an F-Key Macro Recording Session

1. After an F-Key macro recording session has been started, the session can be canceled at any time by accessing the F-Key Recording menu and selecting 'Abort F-KEY Recording' option.
2. The panel will return to the idle screen.

10.9.3 Erasing an F-Key Macro

1. If an F-Key macro has already been recorded, you can erase it by accessing the F-Key Recording menu and selecting the 'Erase F-KEY Macro' option.
2. The panel will return to the idle screen.

10.9.4 Using a Recorded F-Key Macro

1. From the idle screen on any annunciator in the site, press the F-Key you want to activate.
2. Once finished, to de-activate the macro press the F-Key again.

10.9.5 F-Key Status Event

When an F-Key is enabled, it activates its corresponding F-Key Active event. This is a status type event that can activate outputs without showing any status on annunciator displays. This should be used for ancillary purposes only.

10.9.6 F-Key Map Inhibit

The F-Keys have the ability to disable event - output group mapping for the purpose of simulating that the map doesn't exist. This can be setup to allow for testing purposes where notification of an entire building is not desired during the test. This option is programmable for each output group map through HFSS Honeywell Fire Software Suite.

When an F-Key is active and a map in the system is set to be disable by Map Inhibit, the system will show a trouble event indicating it as such.

Section 11

Emergency Voice System Operation

11.1 Overview

The EVS series control panels and accessories provide features to meet the requirements for Mass Notification Systems as described in NFPA 72 and is compliant with the UL 2572 standard. EVS (Emergency Voice System) is integrated with the fire alarm and voice evacuation functions of the control panel. In a networked panel system, only one panel can be chosen to be the voice evacuation/EVS panel for the site.

There are two ways for activating EVS in the 6820EVS panel:

EVS Point Activations

EVS Point Activation involves using pre-determined EVS Alarm input points to activate EVS Alarm events. These events cause output areas to activate based on mapping that is programmed into the system at installation. This is very similar to the traditional mapping that the fire system has utilized to date.

Manual LOC Activations

Manual LOC Activation involves using the LOC EVS interface to activate EVS Events, choose output areas, and speak through a microphone. These selections are not pre-determined and allow the user to make system functionality decisions when the event is actually happening. This requires the activation of Manual EVS State which bypasses EVS Point Activations. See section 11.2.3.

11.2 LOC Functionality

An LOC consists of either the EVS Series panel (EVS-VCM Voice Control Module and the Fire Alarm Control Panel), or the EVS-LOC Remote Command Unit (EVS-RVM Remote Voice Module and its associated 6860 keypad). An LOC is created by adding a VCM or RVM to the system and associating a keypad to it. The LOC provides eight buttons for activating the EVS messages, a button to gain and relinquish EVS Control, and a microphone for live EVS paging. There can be up to five LOC devices in the system. In a networked panel system, all of the LOCs must be connected through SBUS to the panel that includes the VCM.

11.2.1 Keys and LEDs

This section outlines the functionality of the keys and LEDs on the EVS-VCM and EVS-RVM expander modules.

11.2.1.1 EVS Control Key

Pressing the EVS Control Key will do one of two things:

1. Enter Message Mode of the LOC EVS interface (including trying to gain EVS Control if the user doesn't have it already).
2. Relinquish EVS Control if pressed while in Message Mode.

11.2.1.2 EVS Control LED

The EVS Control LED is used to indicate the status of EVS Control in the system. When the LED is on solid, the LOC has EVS Control within the system. When the LED is blinking, another LOC has gained EVS Control in

the system.

11.2.1.3 EVS Message Keys

EVS Message Keys are used in Message Mode to select which EVS Message is to be played. If pressed when the LOC does not have EVS Control, the system will automatically try to gain EVS Control before allowing the EVS Event to be activated. See section 11.2.2.

11.2.1.4 EVS Message LEDs

The red EVS Message LEDs indicate the active EVS Message and any previously active EVS messages. The green LEDs indicate the EVS Message was selected in message mode and that the LOC has EVS control.

1. For EVS Point Activation, the red EVS Message LEDs will illuminate on each LOC to indicate which EVS messages have been activated in automatic EVS state.
2. In Manual EVS State, the red EVS Message LEDs will indicate which EVS message has been activated at an LOC. See section 11.2.3.
3. The green EVS Message LEDs will activate for the LOC that activated the EVS Message.

11.2.1.5 Select Keys

The Select Keys are used to toggle which output areas are active.

1. If Message Mode is active (see Section 11.2.3), the Select Keys will toggle which areas the active message is distributed to (also toggles the red Select Key LED).

Note: For LOC activated emergency alarm events, if an area is programmed through mapping to be active that area is automatically selected and can not be deactivated using the Select Keys.

2. If Microphone Mode is active (see Section 11.2.3), the Select Keys will toggle which areas the microphone audio is distributed to (also toggles the green Select Key LED).

11.2.1.6 Select Key LEDs

The Select Key LEDs are used to indicate which output areas are active for a microphone page (see Section 11.7.5) or system events.

1. Green LEDs: active areas for microphone paging.

Note: These are only active when the microphone PTT (Push To Talk) is engaged.

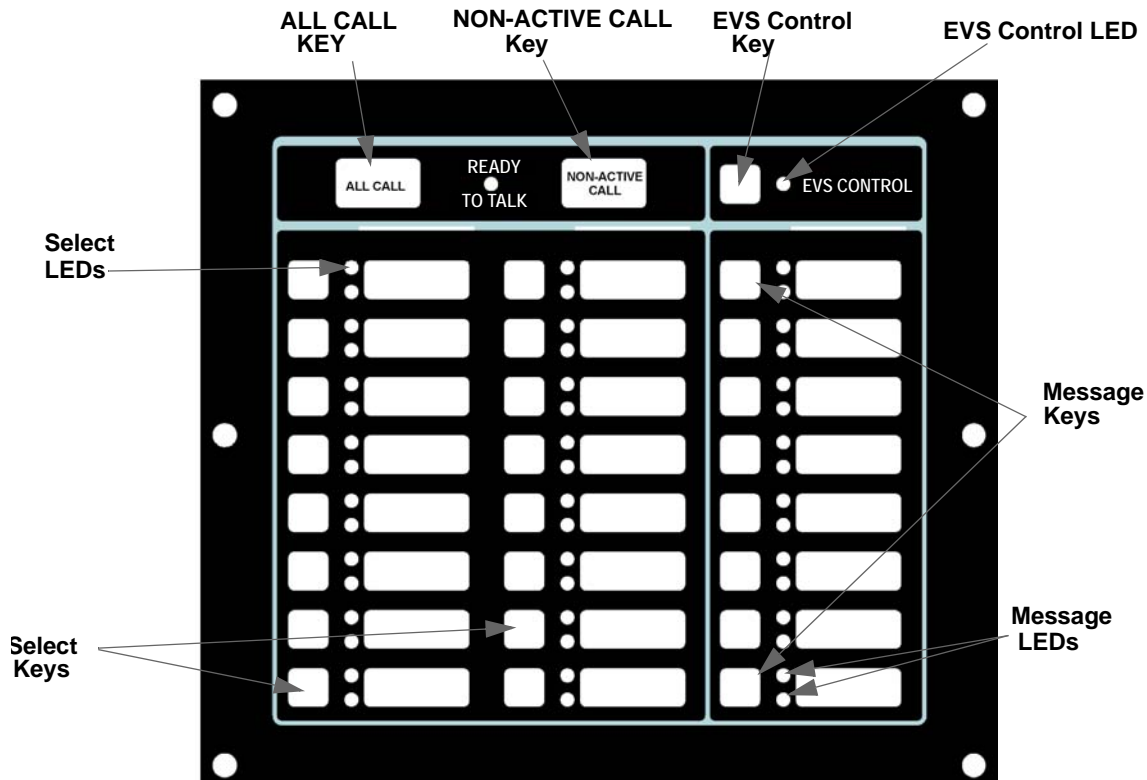

Figure 11-1 EVS-VCM / EVS-RVM Front View

11.2.2 Gaining EVS Control

When attempting to gain EVS Control, there are three things that govern whether or not EVS Control can be obtained:

1. LOC Priority.
2. LOC Lockout.
3. User profile access control.

11.2.2.1 LOC Priority

LOCs are assigned (through panel or HFSS Honeywell Fire Software Suite programming of the EVS-VCM or EVS-RVM) an LOC priority of low, normal, or high. LOCs with a higher priority are always able to gain control from a lower priority LOC.

11.2.2.2 LOC Lockout

When LOCs are programmed to the same priority, the setting LOC lockout applies. LOC lockout will not allow an LOC to gain EVS Control from the LOC with EVS Control until one of three things happen:

1. The LOC lockout timer expires. Once the LOC lockout timer expires, an attempt to gain EVS Control can be made again.

Note: The lockout timer must be programmed to expire sometime other than Never.

2. The user at the second LOC requests EVS Control from the LOC with EVS Control and that LOC grants the request. (See Section 11.2.7). If the EVS lockout timer expires while an EVS Control request is in progress, the system will automatically pass EVS Control to the requesting LOC.
3. The user at the second LOC enters an access code with the EVS Super User profile option.

The LOC lockout timer can be set between immediate and 12 hours in increments of 1 second or it can be set to never expire. The default setting is 30 seconds. The LOC lockout timer is restarted upon any key press at the LOC with EVS control. The LOC lockout timer is cleared when EVS Control is relinquished.

11.2.2.3 User Profile Access Control

The user will need to enter an access code containing the EVS Control Request or EVS Super User profile option to gain EVS Control. EVS Control Request and EVS Super User profile options will be mutually exclusive to the system. If the access code has EVS Super User, the EVS Control Request is ignored and activations by that user are always as EVS Super User.

11.2.3 Manual EVS

After gaining EVS Control the system enters the LOC EVS interface which allows you to activate the Emergency System and allows for Emergency Paging. Once an emergency event has been activated the panel enters a Manual EVS State. In this state, all EVS Alarm programmed points that are currently in alarm in the system are changed to an active state. The display status screen reflects this when viewing the system for status. Any outputs that were activated by the EVS Alarm programmed points are deactivated until Manual EVS state is exited. Only an EVS Reset can exit the Manual EVS State. If a user gains EVS Control at an LOC and does not activate an EVS message, the system will automatically generate an EVS Supervisory indicating such. This prevents an LOC from being in an undesired state of EVS Control when an actual event emerges.

There are two modes for interacting with the LOC EVS interface when in Manual EVS State:

1. Message Mode
2. Microphone Mode

These two modes allow you to quickly toggle areas of output for a desired message or to speak to a microphone for EVS Paging.

After gaining EVS Control, the system is in Message Mode of the Manual EVS State.

11.2.3.1 Switching between Microphone Mode and Message Mode

At any time while in EVS Control, you can switch between Microphone Mode and Message Mode. Microphone Mode is entered by simply engaging the microphone.

1. Message Mode: Use the EVS Message keys to toggle which message/event to output to the system. Use the Select Keys to toggle output areas to play the current EVS Message in. The Select Key's red LED will toggle on/off with the activation/deactivation of the area is now receiving the message. Any non-voice groups assigned to this Select Key will also toggle with their Activation Cadence. See Section 11.2.3.2.
2. Microphone Mode: Use the Select Keys while the microphone is active to toggle which areas to do an EVS Microphone Page to. The Select Key's green LED will toggle on/off with the activation/deactivation of the EVS Microphone Page to the area.

11.2.3.2 Activating Output Groups Dynamically

This method allows the system to be setup with minimal or no system mapping. When in Manual EVS State and operating in Message Mode the user can dynamically activate/deactivate output areas for system notification to take place in. The Select Key red LED will become lit and the circuits in the output group(s) will become active

and play the currently active EVS event message when activated. When deactivated, the Select Key red LED will become unlit and the circuits in the output group(s) will become inactive. Non-voice output groups can also be assigned to Select Keys and will toggle on/off using the activation cadence assigned to it in output group programming. This is available in the panel and in HFSS Honeywell Fire Software Suite. See Section 9.4.1.2.

11.2.4 Microphone Mode

Microphone Mode allows the user to press the Select Keys to toggle which output areas to speak to over the microphone. The green LEDs next to the Select Keys will activate or deactivate.

```

MICROPHONE MODE
SELECT KEYS: Toggle Output Areas
Microphone Active
Release Microphone for MESSAGE MODE

```

11.2.5 Message Mode

In Message Mode, the user is able to press the EVS Message Keys to choose a message and press the Select Keys to activate or deactivate which output areas the message will be played. This will activate or deactivate the green and red LEDs next to the EVS Message Keys and the red LEDs next to the Select Keys.

11.2.6 Custom EVS Event

Custom EVS events allows the user to generate an EVS event and speak a custom message using the microphone. Once the user is done speaking the message, the tone and any associated strobes will continue to be active in the output areas.

To generate a Custom EVS Event:

1. Gain EVS Control using the EVS Control Key when there is not an active Manual EVS State Event.
2. Activate the microphone.
3. Choose desired output areas using the Select Keys.
4. Speak custom message into microphone.

11.2.7 Passing EVS Control

Passing of EVS Control is allowed when two LOCs have the same priority. When it is possible to pass control, a prompt (similar to Figure 11-2) will display in which the user can: request control from the LOC with EVS Control, enter an access code with the EVS Super User profile option to override the other LOC, or wait for the lockout timer to expire (if applicable).

```

GAIN EVS CONTROL OPTIONS MENU
1=Request EVS Control From LOC
2 Gain EVS Control as EVS Super User
3 Wait for Lockout Timer to Expire 10:25

```

Figure 11-2 Request EVS Control with Lockout Timer Active

When passing EVS Control between two EVS Super Users, the user is not shown the prompt screen. Instead, a request for EVS Control is automatically made. Additionally, the lockout timer does not apply for EVS Super User.

When a request for EVS Control is made, the LOC with EVS Control will be shown a screen (similar to Figure 11-3), even when in another menu, except programming menus, indicating that another LOC is requesting EVS Control. The piezo buzzer on the LOC with EVS Control sound when an EVS Control request is active to alert a

nearby operator of the request.

```

Another LOC is Requesting EVS Control:
      EVS-LOC 01
1=Grant, Pass EVS Control
2 Deny, Keep EVS Control

```

Figure 11-3 EVS Control Request on LOC with EVS Control

Once EVS Control is passed to another LOC, the new user will assume the system AS IS. This means that the event that was set to be playing at the previous LOC and all output areas it was playing in do not change.

11.2.8 Exit EVS Control Menu

The user can exit the LOC EVS interface by pressing the left arrow. The user will be returned to the idle screen which indicates that the LOC still has EVS control.

11.2.9 Relinquish EVS Control

Relinquishing EVS Control is accomplished by pressing the EVS Control Key from within Message Mode. A screen will be displayed to ensure the user wants to relinquish EVS Control. EVS Control will be automatically relinquished after a time-out on this screen. When EVS Control is relinquished, the system stays in the Manual EVS State. EVS Control can then be gained by another LOC or again at the same LOC.

```

Relinquish EVS Control
Automatic EVS Timer: 30
1=Cancel, Keep EVS Control
2 Accept, Relinquish EVS Control

```

Figure 11-4 Relinquish EVS Control Screen

11.2.10 EVS Reset

An EVS reset is accomplished by pressing the RESET button from an LOC. The user will be prompted to reset either the fire system or emergency system. After an EVS reset, the LOC will automatically exit the LOC EVS interface.

Note: In order to perform an EVS reset, the display must be associated with the EVS-VCM / EVS-RVM. See Section 11.6.2.2.

11.3 EVS Super User

The EVS Super User access code profile function provides the ability to override all EVS Control rules and gain EVS Control. The EVS Super User is the highest priority user in the system. The EVS Super User has several features that differ from the normal user:

1. Any alarm activated while under EVS Super User Control needs to be reset using an EVS Super User function enabled access code.
2. LOC priority and LOC lockout timer are ignored when passing EVS Control between EVS Super Users at LOCs. If another EVS Super User attempts to gain EVS Control from an LOC, an EVS Control request is presented to the EVS Super User at the LOC that currently has EVS Control.

11.4 EVS Point Functionality

Any input point in the system can be configured as an EVS input. The Point EVS 1-8 Alarm input types can be used to trigger predetermined EVS events for output areas. EVS-VCM, or EVS-RVM points can be programmed

to trigger Voice Aux events that can allow external audio to be played through the emergency system.

11.4.1 EVS Point Activations

EVS points can only activate outputs and be placed into an alarm state if the system is not in Manual EVS State. EVS points have no priority and all are allowed to be activated. If the EVS point is a higher priority than the Fire System, then the system will play the highest event message through all EVS mapped outputs.

For example: Emergency 1 Point Alarm is higher priority than Emergency 2 Point Alarm. Emergency 1 Point Alarm has message 1 mapped to through groups 1 and 2. Emergency 2 Point Alarm has message 2 playing through groups 2 and 3. If a point for Emergency 1 Point Alarm and a point for Emergency 2 Point Alarm are both active, the system will play message 1 through groups 1, 2, and 3.

Once Manual EVS State is active, points in Alarm state switch to an Active state. When the points are changed to the Active state, they do not activate any system mapping or turn any outputs on. Any points that are activated while in Manual EVS are also placed into the Active state and are not allowed to activate any mapping. The system idle screen will show an EVS Alarm for any points in the Active state, and the detailed description of the point will show the point as Active.

After an EVS Reset, any EVS points that are still active will again be put into Alarm.

11.4.2 EVS-VCM & EVS-RVM Points

The EVS-VCM and EVS-RVM modules contain two programmable input points. These also have the ability to be programmed as a trigger for bringing external audio into the system. These special point types are: Voice Aux EVS and Voice Aux Status. When activated, if the event has the highest Event Priority of all activated events, these points will activate the Aux In input to all outputs defined by the respective event program mapping.

Note: Background Music is only allowed to be mapped to circuit 8 of the EVS-100W amplifiers to ensure correct active supervision.

11.5 Amplifier Programming

11.5.1 Adding an Amplifier

To add a new amplifier to the system, follow these steps:

1. Enter the installer code. The panel will automatically go to the main menu.
2. Select 7 for Program Menu.
3. Press 1 to enter Module menu.
4. Press 2 to add a module.
5. From the next screen, select desired amplifier.

The screen will display “Adding module [#]...” for a few moments. You will be returned to the <New Module Type> screen where you can select another module if desired.

You must save changes when you exit the Program Menu or the new module will not be added. For more information see section 9.2.2.

If you Add a Module that has not been physically connected, the panel will go into trouble after it re-initializes (when you exit the Program Menu with changes accepted). When the new module is attached, the trouble will restore automatically the next time you power up the FACP.

11.5.2 Editing an Amplifier

When editing amplifiers, the features that may be edited are (dependent upon amplifier model): module ID, module name, EVS-CE4 Exp installed (Yes or No), output voltage, and amp mode. To edit an existing module:

1. Enter the installer code. The panel will automatically go to the main menu.
2. Select 7 for Program Menu.
3. Press 1 to enter Module menu.
4. Press 1 to edit a module.
5. Use the up or down arrow to select the module you wish to edit.
6. Press the right arrow or ENTER to move to the next selection.

11.6 LOC Programming

Device Priority is a programmable option for each of the EVS devices:

- EVS-VCM
- EVS-RVM

Each device is assigned a Priority level: Low, Normal, or High.

11.6.1 Adding an LOC

To add new LOCs to the system, follow these steps:

1. Enter the installer code. The panel will automatically go to the main menu.
2. Select 7 for Panel Program Menu.
3. Press 1 to enter Module menu.
4. Press 2 to add a module.
5. From the next screen, add either an *EVS-VCM or **EVS-RVM.

*Note: * Only 1 EVS-VCM may be installed per site.*

*Note: ** Up to 4 EVS-RVMs may be installed per site.*

The screen will display “Adding module [#]...” for a few moments. You will be returned to the <New Module Type> screen where you can select a name for the module if desired.

6. Add a compatible LCD Annunciator, if desired, to associate with each EVS-VCM or EVS-RVM

You must save changes when you exit the Program Menu or the new module(s) will not be added. For more information see section 9.2.2.

Note: If you Add a Module that has not been physically connected, the panel will go into trouble after it re-initializes (when you exit the Program Menu). When the new module is attached, the trouble will restore automatically the next time you power up the system.

11.6.2 Editing an LOC

When editing EVS LOCs, the features that may be edited are: module ID, module name, number of switch expanders installed, extended features, microphone type, microphone gain, auxiliary gain, tone gain, message gain, keypad priority, and associated keypad

To edit an existing module:

1. Enter the installer code.
2. Select 7 for Program Menu.
3. Press 1 to enter module menu.
4. Press 1 to edit a module.
5. Use the up or down arrow to select the module you wish to edit.

6. Press the right arrow or ENTER to move to next selection.

11.6.2.1 LOC Priority

Each device is assigned a Priority level: Low, Normal, or High. This is modified by editing the LOC's EVS-VCM or EVS-RVM module. By default, the EVS-VCM has a high LOC priority. The EVS-RVM is defaulted to normal LOC priority.

11.6.2.2 LOC Association

In order to create an LOC, an annunciator must be associated to an EVS-VCM or EVS-RVM. This is done by editing the EVS-VCM or EVS-RVM module and selecting the correct annunciator for the associated device. During JumpStart, the EVS-VCM is automatically associated with the internal annunciator. The association for other LOCs in the system must be performed in programming.

11.7 Using the Microphone

11.7.1 Microphone Functionality

Each microphone in the system is capable of providing live fire system or EVS paging.

The microphones are housed within the EVS-Series panel enclosure and the EVS-LOC cabinets. A maximum of five microphones can be installed in the system.

11.7.2 Custom EVS Event

This event is activated by gaining EVS control at an LOC and using the microphone without any EVS event already active. In this case, the custom EVS mapping and general EVS mapping will be activated and stay activated until a different EVS event is activated at the LOC or the user resets the Emergency Voice System.

11.7.3 Fire Page

A fire page can only occur when:

1. Only the fire system is active.
2. Both fire and EVS are active and the fire alarm is programmed to be of higher priority than the active EVS alarm.
 - If the fire alarm has the highest active priority and EVS is also active, any LOC can do a fire page given LOC device priority rules are followed. If the user is at the LOC with EVS Control, and the fire page is of higher priority than the EVS event, the LOC will automatically relinquish EVS Control to do the fire page when the user engages the microphone.
3. Only the fire system is active, the user has gained EVS Control and custom EVS event is a lower priority than the fire alarm.
 - In this case, if any LOC has EVS Control, the LOC will automatically relinquish control to allow for the fire page.
4. If both the fire alarm and EVS are active and the active EVS event is programmed for higher priority than fire alarm; the user must also have gained EVS control.
 - In this case a fire page is NOT allowed at all and the LOC must gain EVS control in order to do any live voice.

11.7.4 Emergency Page

An emergency page can occur when:

1. Only the emergency system is active and the user has gained EVS Control.
2. Only fire alarm is active, custom EVS is higher priority than fire alarm and the user has gained EVS Control.
 - This will trigger the EVS system and enable mapping for 'Custom EVS' and 'General EVS'.

11.7.5 Paging

If there are no active emergency or fire system events, the microphone at an LOC can be used for paging by following these steps:

1. Remove the microphone from its cradle.
2. Press the push-to-talk button on the microphone.
3. Use the Select Keys on the LOC to toggle the output areas to page to with the microphone (illuminates the green LEDs).

Note: The Ready to Talk LED will illuminate after an output area has been activated.

4. Speak into the microphone.
5. Release PTT button when finished.

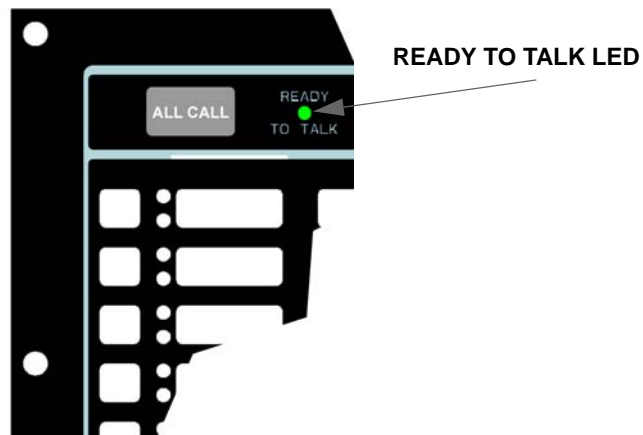

11.8 Recording Custom Messages

The EVS-Series controls come with 15 recordable message slots. Message 1-15 can be recorded from the microphone, Aux Input or by using the HFSS Honeywell Fire Software Suite message management utility. All messages can be a maximum of one minute.

When in the record mode the EVS-VCM switches will function as follows:

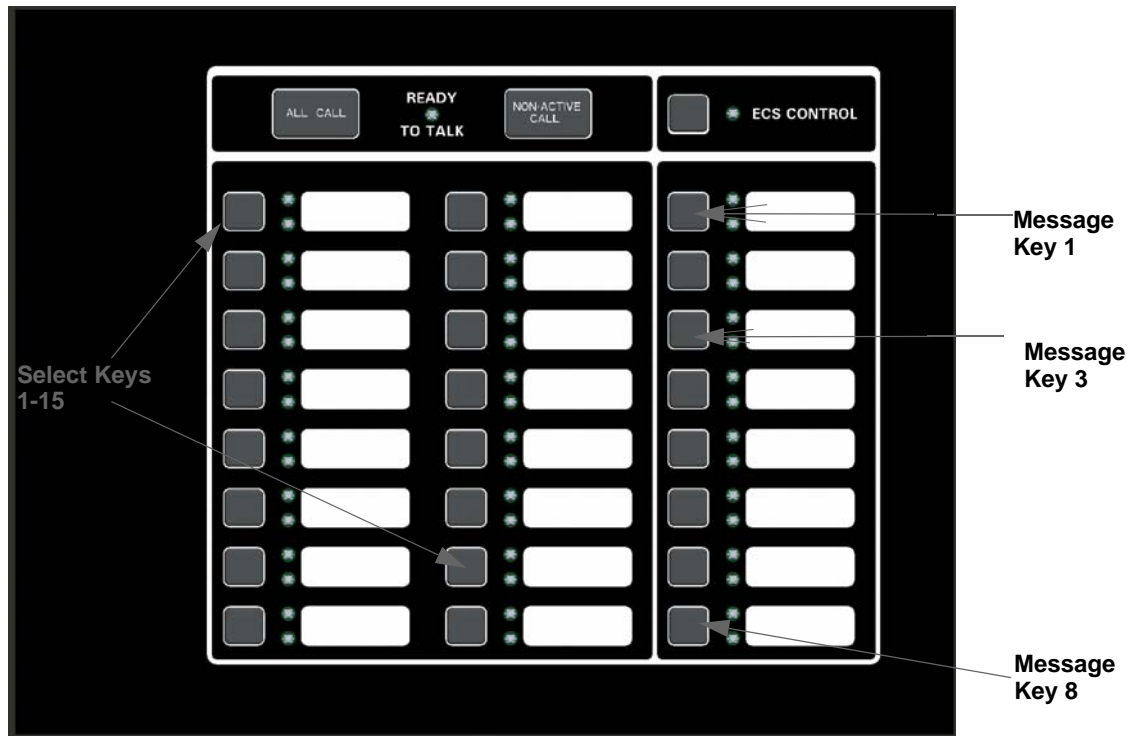

Key	Function
EVS Message Key 1	Select message slot to record to
EVS Message Key 3	Start and stop recording from Aux Audio Input
EVS Message Key 8	Erase user message 1-15
Select Keys 1-15	Message slot 1-15

While in the Local Record mode, select keys 1-15 will be used to reference message slots 1-15. The associated green Select Key will indicate that a message is currently programmed in the corresponding slot. When there is no message recorded (or the message is erased), the associated green Select Key LED will be off. While recording a particular message, the red Select Key will turn on until recording is completed. The Select Key 1-15 will be used to playback a recorded message or to select a message slot to record to or erase.

When in the Local Record mode, the EVS-VCM LEDs will function as follows:

Table 11-1: LED Functions During Programming

Switch LED	Active LED Status	Meaning
Select Key 1-15 Green LED	On	Message is currently programmed in this slot
Select Key 1-15 Red LED	On	Message recording is in progress
Select Key 1-15 Green/Red LED	Off/Off	Message slot is empty

Table 11-1: LED Functions During Programming

Switch LED	Active LED Status	Meaning
Select Key 1-15 Red LED	Flashing	Message is being played back or message is selected for recording

11.8.1 Recording Messages 1-15 Using Aux Audio Input

Recording messages from the Aux Audio Input enables you to load customized, pre-recorded messages into an EVS message location.

Follow these steps to record user message using Aux Audio Input:

Note: Refer to the Section 7 for detailed programming information.

1. Wire a speaker cable with 1/8" mini plug (Radio Shack Cat. No. 42-2454) to the Aux AUDIO GND and IN terminals. Refer to Figure 11-5.

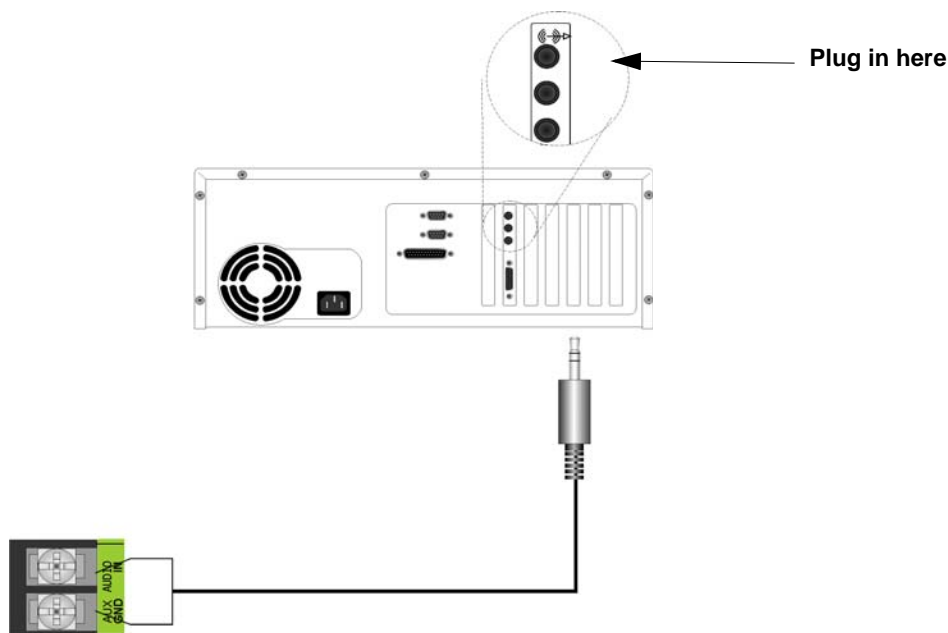

Figure 11-5 AUX Audio Connection for Recording

2. Plug the mini plug into the Line Out/Headphone jack on a PC or laptop. See Figure 11-5.
3. Enter programming mode at main control panel.
4. Select option 8 VCM Maintenance.
5. Select option 2 Local Recording.

Note: The VCM will light the green Select Key LED for message slots that are occupied. If a message is already stored in the desired slot, then you must erase the message first. (see 11.8.3).

6. Select the amplifier and circuit for the audio to play through during programming. A user would generally pick the audio circuit that is in closest proximity to them.
7. Press EVS Message Key 1 to enter the message slot selection mode. Then, press the Select Key 1-15 that corresponds to the message slot that you wish to record to. The associated Select Key red LED will begin flashing, indicating that the message slot is ready for recording.
8. Simultaneously press EVS Message Key 3 and start playing the audio source on the PC or laptop.

9. When the audio file from the PC is finished playing, press EVS Message Key 3 again to stop the recording. The Select Key green LED will come on.
10. To playback the recorded message, press the Select Key 1-15 that was just recorded to.

Recording with Aux Audio Input Example:

The user wants to record into memory slot 2 via the Aux Audio Input channel.

Upon entering the Local Recording mode via the keypad menu, the VCM will light the Select Key green LEDs 1-15 for each occupied message slot.

If a message already exists in message slot 2, it must first be erased. Press EVS Message Key 8, then press Select Key 2, (see Section 11.8.3). When the message has been erased Select Key 2's green LED will turn off.

To record a message, press EVS Message Key 1, then press Select Key 2 (this will use message slot 2 for the recording). Select Key 2's red LED will begin flashing.

Press EVS Message Key 3 while simultaneously pressing play on the PC to start recording the Aux Audio Input. When the PC message is done, press EVS Message Key 3 to stop recording. Select Key 2's red LED will stay on until processing is completed. Select Key 2's green LED comes on after the recording is completed.

Pressing Select Key 2 will start a playback of the recorded message.

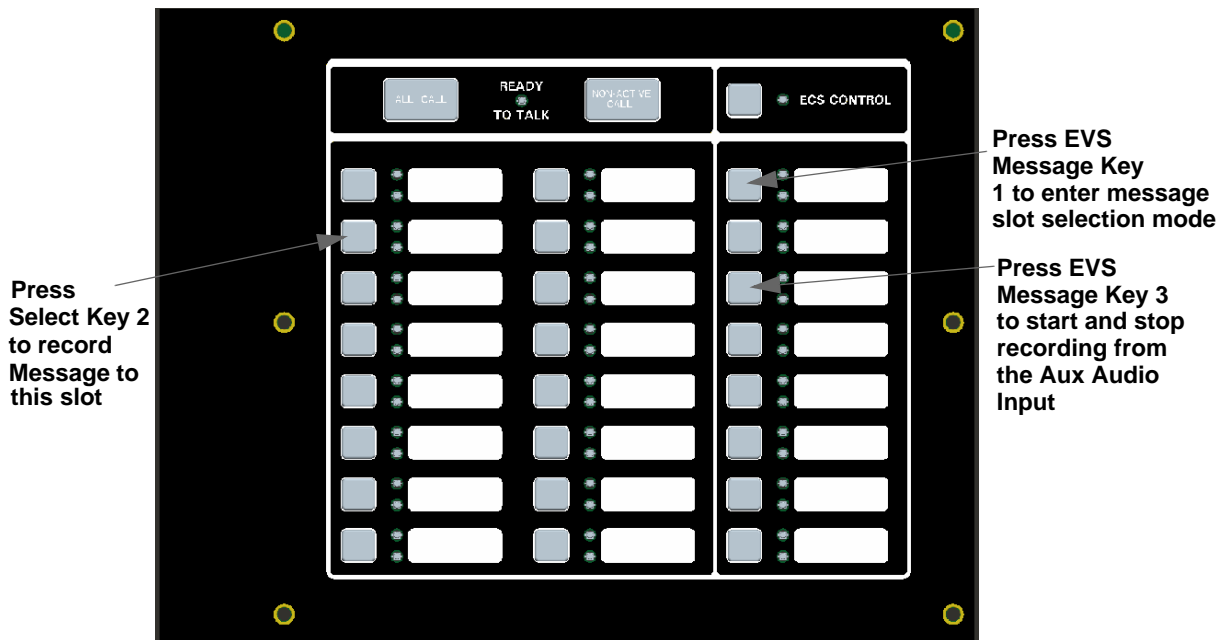

Figure 11-6 Aux Audio Input Example

11.8.2 Recording Messages 1-15 Using the Microphone

Messages can be recorded into the EVS system by using the on board microphone.

Follow these steps to use the microphone to record your message:

1. Enter programming mode at main control panel.
2. Select option 8 Voice Options.
3. Select 1 for VCM Maintenance.
4. Select option 2 Local Recording.

Note: The VCM will light the green Select Key LED for message slots that are occupied. If a message is already

stored in the desired slot, then you must erase the message first. (see Section 11.8.3).

5. Select the amplifier and circuit for the audio to play through during programming. A user would generally pick the audio circuit that is in closest proximity to them.
6. Press EVS Message Key 1 to enter the message slot selection mode. Then, press the Select Key 1-15 that corresponds to the message slot that you wish to record to. The associated Select Key red LED will begin flashing, indicating that the message slot is ready for recording.
7. Press the push-to-talk (PTT) button on the microphone and speak your message.
8. Release the PTT button on the microphone to save your message. The Select Key green LED for this location will turn on.
9. To playback the recorded message, press the Select Key 1-15 that was just recorded to.
10. If you are not satisfied with the recorded message, erase it (see Section 11.8.3) and then repeat steps 1 through 7.

Recording with Microphone Example:

User wants to record a message to message slot 5 via the microphone.

Upon entering the Local Recording mode via the keypad menu, the VCM will light the Select Key green LEDs for 1-15 for each occupied message slot.

If a message already exists in message slot 5, it must first be erased. Press EVS Message key 8, then press Select Key 5, (see Section 11.8.3). When the message has been erased Select Key 5's green LED will turn off.

To record a message, press EVS Message Key 1, press Select Key 5 (this will use message slot 5 for the recording). Select Key 5's red LED will begin flashing.

Press the push-to-talk button on the microphone and speak your message. Release the PTT button to save your message. Select Key 5's red LED stays on until processing is completed. Select Key 5's green LED comes on after the recording is completed.

Pressing Select Key 5 will start a playback of the recorded message.

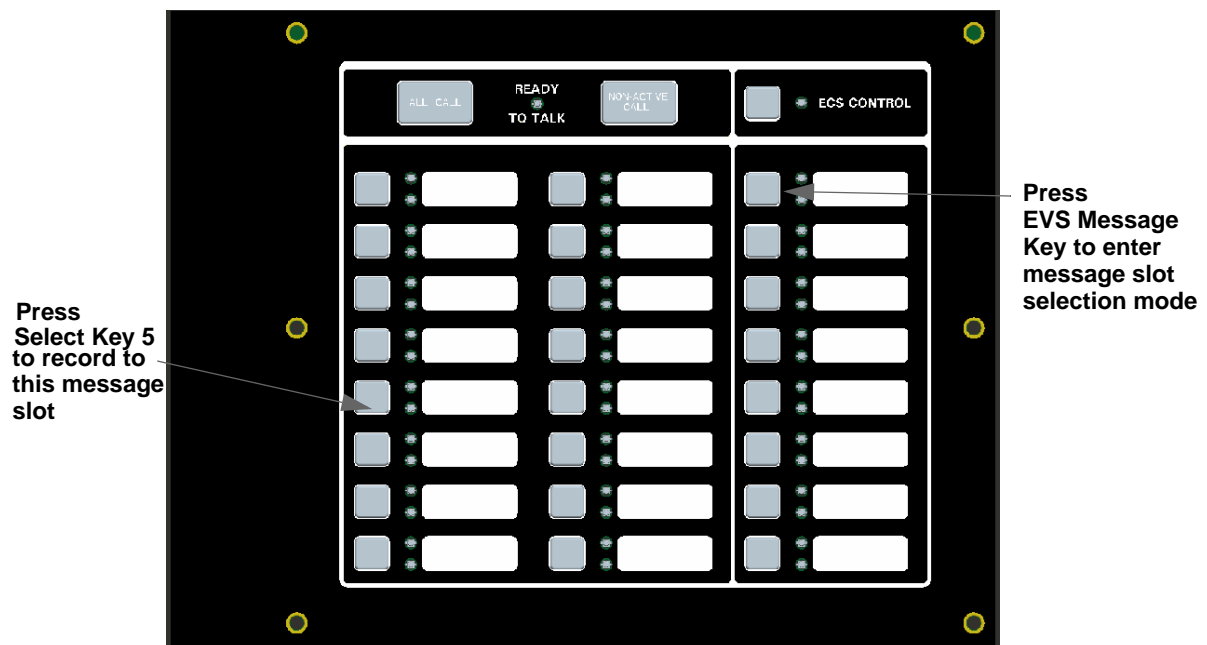

Figure 11-7 Recording with Microphone Example

11.8.3 Erasing User Message

To erase the message stored in switch 1-15 memory location follow these steps:

1. Enter programming mode at main control panel.
2. Select option 9 Voice Options.
3. Select option 1 VCM Maintenance.
4. Select option 2 Local Recording. Once in this mode, the VCM/RVM will light all the green LEDs for switches 1-15 indicating which message slots are occupied.
5. Select the amplifier and circuit for the audio to play through during programming. A user would generally pick the audio circuit that is in closest proximity to them
6. Press EVS Message Key 8 on the EVS-VCM, press the Select Key 1-15 that you wish to erase. The Select Key red LED will stay on until the erase is done. When erased, the Select Key green LED by corresponding to the message slot you erased will go off.

11.8.4 Using HFSS Voice Message Load Software

The HFSS Voice Message Load Software is a software support utility that is used to download recorded messages (in .SKE1 format stored on your PC hard drive) to the various message locations of the EVS-Series controls. Messages can be uploaded from the EVS-Series control, stored, and used again in similar installations.

To read/write .SKE1 formatted messages to and from the main panel, follow these steps:

1. Make sure that panel is in Normal mode.
2. Connect the PC to the VCM using a standard USB cable. See Figure 11-8.

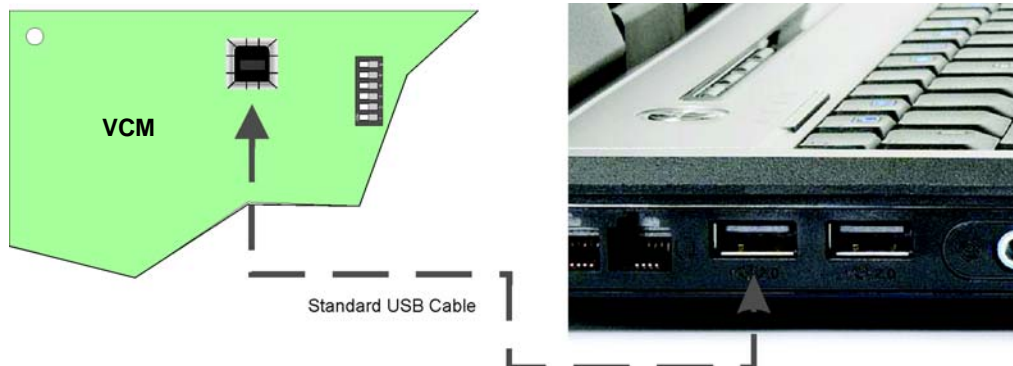

Figure 11-8 USB Cable Connections

3. Run the Voice Message Load software.
4. Select “Read from Panel” to read a message and store onto your hard drive, or “Write to Panel” to transfer a .SKE1 formatted message to the panel.
5. Select the appropriate message location you wish to read/write.
6. Enter the file name you wish to transfer (Press “Browse” to display a list of files.)
7. Press “Start” to start the transfer.

Section 12

Reporting

This section lists receivers that are compatible with this control panel, and the reporting codes sent by the control panel for SIA and Contact ID formats.

12.1 Receivers Compatible with the Control Panel

Table 12-1 shows receivers compatible with the control panel.

Table 12-1: Receivers Compatible with the Control Panel

Manufacturer	Model	Format
Honeywell	Model 9800	SIA and Contact ID
	Model 9000 (SIA formats)	SIA
Honeywell Security	AlarmNet 7810-ir	IP and Cellular Receiver, Contact ID only
Ademco	MX8000	SIA and Contact ID
Ademco	Model 685 (Contact ID)	Contact ID
Sur-Gard	SG-MLR2-DG (V. 1.64 or higher)	SIA and Contact ID
Osborne Hoffman	Quickalert	SIA and Contact ID

Table 12-2: Reporting Formats Table

Event Description	SIA Reporting Format				Contact ID Reporting Format			
	Module ID # (If Any)	SIA Event Codes	Parameter	SIA	Qualifier	Event Code	Group #	Contact #
				Fixed Length Format NN - panel ID XX- SBUS ID ZZZ- Zone # PPPP- Point # GGG- Group # E- Emergency # RRRR-Receiver #				
System Events	Note: System Events are reported when either "Report by Point" or Report by Zone is selected							
AC power low trouble		AT	0	ATNN000000	1	301	00	000
AC power low trouble restore		AR	0	ARNN000000	3	301	00	000
Auto dialer test communications trouble line 1		YC	1	YCNN000001	1	350	Receiver #	001
Auto dialer test communications trouble line 1 restore		YK	1	YKNN000001	3	350	Receiver #	001
Auto dialer test communications trouble line 2		YC	2	YCNN000002	1	350	Receiver #	002
Auto dialer test communications trouble line 2 restore		YK	2	YKNN000002	3	350	Receiver #	002
Automatic test normal		RP	0	RPNN000000	1	602	00	000

Table 12-2: Reporting Formats Table

Event Description	SIA Reporting Format			Contact ID Reporting Format				
	Module ID # (If Any)	SIA Event Codes	Parameter	Fixed Length Format NN - panel ID XX- SBUS ID ZZZ- Zone # PPPP- Point # GGG- Group # E- Emergency # RRRR-Receiver #	Qualifier	Event Code	Group #	Contact #
Automatic test off normal		RY	0	RYNN000000	1	608	00	000
Battery voltage trouble		YT	Exp. ID	YTNNXX0000	1	302	Exp. ID	000
Battery voltage trouble restore		YR	Exp. ID	YRNNXX0000	3	302	Exp. ID	000
Date changed event		JD	0	JDNN000000	1	625	00	000
EVS Reset		OR	1	ORNN000001	1	401	00	001
Emergency System Overridden		QS	0	QSNN000000	1	244	00	000
Emergency System Overridden Restore		QR	0	QRNN000000	3	244	00	000
Fire drill has begun		FI	0	FINN000000	1	604	00	000
Fire drill has ended		FK	0	FKNN000000	3	604	00	000
F1 Mapping Inhibited		FT	2001	FTNN002001	1	570	00	001
F1 Mapping Inhibited Restoral		FJ	2001	FJNN002001	3	570	00	001
F2 Mapping Inhibited		FT	2002	FTNN002002	1	570	00	002
F2 Mapping Inhibited Restoral		FJ	2002	FJNN002002	3	570	00	002
F3 Mapping Inhibited		FT	2003	FTNN002003	1	570	00	003
F3 Mapping Inhibited Restoral		FJ	2003	FJNN002003	3	570	00	003
F4 Mapping Inhibited		FT	2004	FTNN002004	1	570	00	004
F4 Mapping Inhibited Restoral		FJ	2004	FJNN002004	3	570	00	004
Fire Reset		OR	0	ORNN000000	1	401	00	000
Fire System Overridden		FS	0	FSNN000000	1	245	00	000
Fire System Override Restore		FR	0	FRNN000000	3	245	00	000
Ground fault condition trouble		YP	Exp. ID	YPNNXX0000	1	310	Exp. ID	000
Ground fault condition trouble restore		YQ	Exp. ID	YQNNXX0000	3	310	Exp. ID	000
Initial power up		RR	0	RRNN000000	1	305	00	000
Local programming aborted or ended with errors		LU	0	LUNN000000	1	628	00	000
Local programming begin		LB	0	LBNN000000	1	627	00	000
Local programming ended normally		LS	0	LSNN000000	1	628	00	000
Network node trouble (panel missing)		EM	Panel ID	EMNNNN0000	1	334	Panel ID	000
Network node trouble restore (panel no longer missing)		EN	Panel ID	ENNNNN0000	3	334	Panel ID	000
OPG Inhibit Trouble		FT	Group # + 1000	FTNN001GGG	1	320	00	Group #

Table 12-2: Reporting Formats Table

Event Description	SIA Reporting Format			Contact ID Reporting Format				
	SIA pi Modifier	SIA	Parameter	Fixed Length Format NN - panel ID XX- SBUS ID ZZZ- Zone # PPPP- Point # GGG- Group # E- Emergency # RRRR-Receiver #	Qualifier	Event Code	Group #	Contact #
OPG Inhibit Trouble Restore		FJ	Group # + 1000	FJNN001GGG	3	320	00	Group #
OPG Inhibit of Releasing Group		SS	Group # + 1000	SSNN001GGG	1	203	00	Group #
OPG Inhibit of Releasing Group Restore		SR	Group # + 1000	SRNN001GGG	3	203	00	Group #
Phone line 1 trouble detected		LT	1	LTNN000001	1	351	00	000
Phone line 1 trouble restore		LR	1	LRNN000001	3	351	00	000
Phone line 2 trouble detected		LT	2	LTNN000002	1	352	00	000
Phone line 2 trouble restore		LR	2	LRNN000002	3	352	00	000
Printer is off-line trouble		VZ	Exp. ID	VZNNXX0000	1	336	Exp. ID	000
Printer is off-line trouble restore		VY	Exp. ID	VYNNXX0000	3	336	Exp. ID	000
Printer is out of paper trouble		VO	Exp. ID	VONNXX0000	1	335	Exp. ID	000
Printer is out of paper trouble restore		VI	Exp. ID	VINNXX0000	3	335	Exp. ID	000
Releasing Notif/Control Circuit Disabled	pi Exp. ID	SS	Point #	SSNNXXPPPP	1	203	Exp. ID	Point #
Releasing Notif/Control Circuit enabled	pi Exp. ID	SR	Point #	SRNNXXPPPP	3	203	Exp. ID	Point #
Remote programming aborted or ended with errors		RU	0	RUNN000000	1	413	00	000
Remote programming ended normally		RS	0	RSNN000000	1	412	00	000
Repeater ground fault trouble		EM	0103	EMNN000103	1	334	Panel ID	103
Repeater ground fault trouble restore		EN	0103	ENNN000103	3	334	Panel ID	103
Repeater missing trouble		EM	0100	EMNN000100	1	334	Panel ID	100
Repeater missing trouble restore		EN	0100	ENNN000100	3	334	Panel ID	100
Repeater Rx1 communication trouble		EM	0101	EMNN000101	1	334	Panel ID	101
Repeater Rx1 communication trouble restore		EN	0101	ENNN000101	3	334	Panel ID	101
Repeater Rx2 communication trouble		EM	0102	EMNN000102	1	334	Panel ID	102
Repeater Rx2 communication trouble restore		EN	0102	ENNN000102	3	334	Panel ID	102
SBUS Class A supervision lost		ET	Exp. ID	ETNNXX0000	1	333	Exp. ID	000
SBUS Class A supervision restore		ER	Exp. ID	ERNNXX0000	3	333	Exp. ID	000

Table 12-2: Reporting Formats Table

Event Description	SIA Reporting Format				Contact ID Reporting Format			
	Module ID # (If Any)	SIA Event Codes	Parameter	SIA	Qualifier	Event Code	Group #	Contact #
SBUS expander trouble		ET	Exp. ID	ETNNXX0000	1	333	Exp. ID	000
SBUS expander trouble restore		ER	Exp. ID	ERNXX0000	3	333	Exp. ID	000
SLC class A supervision trouble		ET	Exp. ID	ETNNXX0000	1	331	Exp. ID	000
SLC class A supervision trouble restore		ER	Exp. ID	ERNXX0000	3	331	Exp. ID	000
SLC programming ended, system active		TE	0	TENN000000	3	607	00	000
SLC programming started, system shut down		TS	0	TSNN000000	1	607	00	000
SLC short circuit trouble		ET	Exp. ID	ETNNXX0000	1	332	Exp. ID	000
SLC short circuit trouble restore		ER	Exp. ID	ERNXX0000	3	332	Exp. ID	000
Time changed event		JT	0	JTNN000000	1	625	00	000
Unable to report to account trouble		RT	Receiver #	RTNN00RRRR	1	354	00	Receiver #
Unable to report to account trouble restore		YK	Receiver #	YKNN00RRRR	3	354	00	Receiver #
User access code changed		JV	0	JVNN000000	1	602	00	000
User initiated manual dialer test		RX	0	RXNN000000	1	601	00	000
Walk test begin		TS	0	TSNN000000	1	607	00	000
Walk test end		TE	0	TENN000000	3	607	00	000
Zone Events	Note: Zone events are reported only when "Report by Zone" is selected							
Auxiliary power trouble		FT	0000	FTNN000000	1	320	00	000
Auxiliary power trouble restore		FJ	0000	FJNN000000	3	320	00	000
CO Detector Alarm		GA	Zone #	GANN00ZZZ	1	162	00	Zone #
CO Detector Alarm Restore		GH	Zone #	GHNN00ZZZ	3	162	00	Zone #
CO Detector Supervisory Alarm		GS	Zone #	GSNN00ZZZ	1	200	00	Zone #
CO Detector Supervisory Alarm Restore		GR	Zone #	GRNN00ZZZ	3	200	00	Zone #
CO Detector Trouble		GT	Zone #	GTNN00ZZZ	1	373	00	Zone #
CO Detector Trouble Restore		GJ	Zone #	GJNN00ZZZ	3	373	00	Zone #
Detector Alarm		FA	Zone #	FANN00ZZZ	1	110	00	Zone #
Detector Alarm Restore		FH	Zone #	FHNN00ZZZ	3	110	00	Zone #
Detector trouble		FT	Zone #	FTNN00ZZZ	1	373	00	Zone #
Detector trouble restore		FJ	Zone #	FJNN00ZZZ	3	373	00	Zone #
EVS Switch Trouble		QT	0	QTNN000000	1	242	00	000
EVS Switch Trouble Restore		QJ	0	QJNN000000	3	242	00	000

Table 12-2: Reporting Formats Table

Event Description	SIA Reporting Format				Contact ID Reporting Format			
	Module ID # (If Any)	SIA Event Codes	Parameter	SIA	Qualifier	Event Code	Group #	Contact #
EVS Supervisory/Tamper Alarm		QS	0	Fixed Length Format NN - panel ID XX- SBUS ID ZZZ- Zone # PPPP- Point # GGG- Group # E- Emergency # RRRR-Receiver #	1	241	00	000
EVS Supervisory/Tamper Alarm Restore		QR	0		3	241	00	000
EVS Output Group Trouble		QT	Group # +1000		1	320	00	Group #
EVS Output Group Trouble Restore		QJ	Group # +1000		3	320	00	Group #
External Reset/Silence/Fire Drill switch trouble		UT	0000		1	373	00	000
External Reset/Silence/Fire Drill switch trouble restore		UJ	0000		3	373	00	000
LOC Mic Activated EVS Alarm		QA	0		1	220	00	000
LOC Mic Activated EVS Alarm Restore		QH	0		3	220	00	000
LOC/Point EVS # Alarm		QA	Emergency #		1	220 + Emergency #	00	000
LOC/Point EVS # Alarm Restore		QH	Emergency #		3	220 + Emergency #	00	000
Manual pull switch alarm		FA	Zone #		1	115	00	Zone #
Manual pull switch alarm restore		FH	Zone #		3	115	00	Zone #
Manual pull switch trouble		FT	Zone #		1	373	00	Zone #
Manual pull switch trouble restore		FJ	Zone #		3	373	00	Zone #
Notification output trouble		FT	Group # + 1000		1	320	00	Group #
Notification output trouble restore		FJ	Group # + 1000		3	320	00	Group #
Positive Alarm Sequence acknowledge switch trouble		FT	Zone #		1	373	00	Zone #
Positive Alarm Sequence acknowledge switch trouble restore		FJ	Zone #		3	373	00	Zone #
SLC LED Module trouble		ET	0000		1	333	00	000
SLC LED Module trouble restore		ER	0000		3	333	00	000
Status Point Types Trouble		UT	0		1	379	00	000
Status Point Types Trouble Restore		UJ	0		3	379	00	000
Supervisory Detector Alarm		FS	Zone #		1	200	00	Zone #

Table 12-2: Reporting Formats Table

Event Description	SIA Reporting Format				Contact ID Reporting Format			
	Module ID # (If Any)	SIA Event Codes	Parameter	SIA Fixed Length Format NN - panel ID XX- SBUS ID ZZZ- Zone # PPPP- Point # GGG- Group # E- Emergency # RRRR-Receiver #	Qualifier	Event Code	Group #	Contact #
Supervisory Detector Alarm Restore		FR	Zone #	FRNN000ZZZ	3	200	00	Zone #
Supervisory/Tamper Alarm		FS	Zone #	FSNN000ZZZ	1	200	00	Zone #
Supervisory/Tamper alarm condition restore		FR	Zone #	FRNN000ZZZ	3	200	00	Zone #
Supervisory/Tamper switch trouble		FT	Zone #	FTNN000ZZZ	1	373	00	Zone #
Supervisory/Tamper switch trouble restore		FJ	Zone #	FJNN000ZZZ	3	373	00	Zone #
System-based AUX1 switch alarm		UA	1000	UANN001000	1	140	01	000
System-based AUX1 switch alarm restore		UH	1000	UHNN001000	3	140	01	000
System-based AUX1 switch trouble		UT	1000	UTNN001000	1	373	01	000
System-based AUX1 switch trouble restore		UJ	1000	UJNN001000	3	373	01	000
System-based AUX2 switch alarm		UA	2000	UANN002000	1	140	02	000
System-based AUX2 switch alarm restore		UH	2000	UHNN002000	3	140	02	000
System-based AUX2 switch trouble		UT	2000	UTNN002000	1	373	02	000
System-based AUX2 switch trouble restore		UJ	2000	UJNN002000	3	373	02	000
Voice Aux EVS 1 Alarm		UA	3	UANN003000	1	171	00	000
Voice Aux EVS 1 Alarm Restore		UH	3	UHNN003000	3	171	00	000
Voice Aux EVS 2 Alarm		UA	4	UANN004000	1	172	00	000
Voice Aux EVS 2 Alarm Restore		UH	4	UHNN004000	3	172	00	000
Voice Aux EVS 3 Alarm		UA	5	UANN005000	1	173	00	000
Voice Aux EVS 3 Alarm Restore		UH	5	UHNN005000	3	173	00	000
Voice Aux EVS 4 Alarm		UA	6	UANN006000	1	174	00	000
Voice Aux EVS 4 Alarm Restore		UH	6	UHNN006000	3	174	00	000
Water flow switch alarm		SA	Zone #	SANN000ZZZ	1	113	00	Zone #
Water flow switch alarm Restore		SH	Zone #	SHNN000ZZZ	3	113	00	Zone #
Water flow switch trouble		ST	Zone #	STNN000ZZZ	1	373	00	Zone #
Water flow switch trouble Restore		SJ	Zone #	SJNN000ZZZ	3	373	00	Zone #

Table 12-2: Reporting Formats Table

Event Description	SIA Reporting Format				Contact ID Reporting Format			
	SIA pi Modifier		SIA		Qualifier	Event Code	Group #	Contact #
Module ID # (If Any)	SIA Event Codes	Parameter	Fixed Length Format NN - panel ID XX- SBUS ID ZZZ- Zone # PPPP- Point # GGG- Group # E- Emergency # RRRR-Receiver #					
Zone-based AUX1 switch alarm		UA	Zone # + 1000	UANN001ZZZ	1	140	01	Zone #
Zone-based AUX1 switch alarm restore		UH	Zone # + 1000	UHNN001ZZZ	3	140	01	Zone #
Zone-based AUX1 switch trouble		UT	Zone # + 1000	UTNN001ZZZ	1	373	01	Zone #
Zone-based AUX1 switch trouble restore		UJ	Zone # + 1000	UJNN001ZZZ	3	373	01	Zone #
Zone-based AUX2 switch alarm		UA	Zone # + 2000	UANN002ZZZ	1	140	02	Zone #
Zone-based AUX2 switch alarm restore		UH	Zone # + 2000	UHNN002ZZZ	3	140	02	Zone #
Zone-based AUX2 switch trouble		UT	Zone # + 2000	UTNN002ZZZ	1	373	02	Zone #
Zone-based AUX2 switch trouble restore		UJ	Zone # + 2000	UJNN002ZZZ	3	373	02	Zone #
Point Events	For SK devices, sensors 1–159 are reported as Points 1–159, modules 1–159 are reported as Points 201–359.							
An unexpected SLC device has been detected	pi Exp. ID	XE	Point #	XENNXPPPP	1	380	Exp. ID	Point #
An unexpected SLC device has been removed	pi Exp. ID	XI	Point #	XINNXPPPP	3	380	Exp. ID	Point #
Auxiliary power disabled	pi Exp. ID	FB	Point #	FBNXXPPPP	1	571	Exp. ID	Point #
Auxiliary power enabled	pi Exp. ID	FU	Point #	FUNNXPPPP	3	571	Exp. ID	Point #
Auxiliary power Trouble	pi Exp. ID	FT	Point #	FTNXXPPPP	1	320	Exp. ID	Point #
Auxiliary power trouble restore	pi Exp. ID	FJ	Point #	FJNXXPPPP	3	320	Exp. ID	Point #
Background Music Switch is Trouble	pi Exp. ID	UT	Point #	UTNXXPPPP	1	379	Exp. ID	Point #
Background Music Switch is Trouble Restored	pi Exp. ID	UJ	Point #	UJNXXPPPP	3	379	Exp. ID	Point #
Background Music Switch is Disabled	pi Exp. ID	UB	Point #	UBNXXPPPP	1	580	Exp. ID	Point #
Background Music Switch is Enabled	pi Exp. ID	UU	Point #	UUNXXPPPP	3	580	Exp. ID	Point #
CO Detector Trouble	pi Exp. ID	GT	Point #	GTNXXPPPP	1	373	Exp. ID	Point #
CO Detector Trouble Restore	pi Exp. ID	GJ	Point #	GJNXXPPPP	3	373	Exp. ID	Point #
CO Detector Disabled	pi Exp. ID	GB	Point #	GBNXXPPPP	1	571	Exp. ID	Point #
CO Detector Enabled	pi Exp. ID	GU	Point #	GUNXXPPPP	3	571	Exp. ID	Point #
Detector Alarm	pi Exp. ID	FA	Point #	FANXXPPPP	1	110	Exp. ID	Point #

Table 12-2: Reporting Formats Table

Event Description	SIA Reporting Format			Contact ID Reporting Format				
	SIA pi Modifier	SIA Event Codes	SIA Parameter	Fixed Length Format NN - panel ID XX- SBUS ID ZZZ- Zone # PPPP- Point # GGG- Group # E- Emergency # RRRR-Receiver #	Qualifier	Event Code	Group #	Contact #
Detector Alarm restore	pi Exp. ID	FH	Point #	FHNNXXPPPP	3	110	Exp. ID	Point #
Detector Disabled	pi Exp. ID	FB	Point #	FBNNXXPPPP	1	571	Exp. ID	Point #
Detector Enabled	pi Exp. ID	FU	Point #	FUNNXXPPPP	3	571	Exp. ID	Point #
Detector Trouble	pi Exp. ID	FT	Point #	FTNNXXPPPP	1	373	Exp. ID	Point #
Detector Trouble restore	pi Exp. ID	FJ	Point #	FJNNXXPPPP	3	373	Exp. ID	Point #
Detector CO Alarm	pi Exp. ID	GA	Point #	GANNXXPPPP	1	162	Exp. ID	Point #
Detector CO Alarm Restore	pi Exp. ID	GH	Point #	GHNNXXPPPP	3	162	Exp. ID	Point #
Detector CO Supervisory Alarm	pi Exp. ID	GS	Point #	GSNNXXPPPP	1	200	Exp. ID	Point #
Detector CO Supervisory Alarm Restore	pi Exp. ID	GR	Point #	GRNNXXPPPP	3	200	Exp. ID	Point #
EVS Alarm # Point Alarm	pi Exp. ID	QA	(EPPP)E - Emergency # PPP - Point #	QANNXXEPPP	1	220 + Emergency #	Exp. ID	Point #
EVS Alarm # Point Alarm Restore	pi Exp. ID	QH	(EPPP)E - Emergency # PPP - Point #	QHNNXXEPPP	3	220 + Emergency #	Exp. ID	Point #
EVS Alarm # Point Trouble	pi Exp. ID	QT	Point #	QTNNXXPPPP	1	242	Exp. ID	Point #
EVS Alarm # Point Trouble Restore	pi Exp. ID	QJ	Point #	QJNNXXPPPP	3	242	Exp. ID	Point #
EVS Alarm # Point Disabled	pi Exp. ID	QB	Point #	QBNNXXPPPP	1	243	Exp. ID	Point #
EVS Alarm # Point Enabled	pi Exp. ID	QU	Point #	QUNNXXPPPP	3	243	Exp. ID	Point #
EVS Supervisory/Tamper Alarm	pi Exp. ID	QS	Point #	QSNNXXPPPP	1	241	Exp. ID	Point #
EVS Supervisory/Tamper Alarm Restore	pi Exp. ID	QR	Point #	QRNNXXPPPP	3	241	Exp. ID	Point #
EVS Supervisory/Tamper Trouble	pi Exp. ID	QT	Point #	QTNNXXPPPP	1	242	Exp. ID	Point #
EVS Supervisory/Tamper Trouble Restore	pi Exp. ID	QJ	Point #	QJNNXXPPPP	3	242	Exp. ID	Point #
EVS Supervisory/Tamper Disabled	pi Exp. ID	QB	Point #	QBNNXXPPPP	1	243	Exp. ID	Point #
EVS Supervisory/Tamper Enabled	pi Exp. ID	QU	Point #	QUNNXXPPPP	3	243	Exp. ID	Point #
EVS NAC Trouble	pi Exp. ID	QT	Point #	QTNNXXPPPP	1	320	Exp. ID	Point #
EVS NAC Trouble Restored	pi Exp. ID	QJ	Point #	QJNNXXPPPP	3	320	Exp. ID	Point #
EVS Control Circuit Trouble	pi Exp. ID	QT	Point #	QTNNXXPPPP	1	320	Exp. ID	Point #

Table 12-2: Reporting Formats Table

Event Description	SIA Reporting Format				Contact ID Reporting Format			
	Module ID # (If Any)	SIA Event Codes	Parameter	Fixed Length Format NN - panel ID XX- SBUS ID ZZZ- Zone # PPPP- Point # GGG- Group # E- Emergency # RRRR-Receiver #	Qualifier	Event Code	Group #	Contact #
EVS Control Circuit Trouble Restored	pi Exp. ID	QJ	Point #	QJNNXXPPPP	3	320	Exp. ID	Point #
EVS Relay Trouble	pi Exp. ID	QT	Point #	QTNNXXPPPP	1	320	Exp. ID	Point #
EVS Relay Trouble Restored	pi Exp. ID	QJ	Point #	QJNNXXPPPP	3	320	Exp. ID	Point #
EVS Notification Trouble	pi Exp. ID	QT	Point #	QTNNXXPPPP	1	320	Exp. ID	Point #
EVS Notification Trouble Restored	pi Exp. ID	QJ	Point #	QJNNXXPPPP	3	320	Exp. ID	Point #
External Reset/Silence/Fire Drill switch disabled	pi Exp. ID	UB	Point #	UBNNXXPPPP	1	571	Exp. ID	Point #
External Reset/Silence/Fire Drill switch enabled	pi Exp. ID	UU	Point #	UUNNXXPPPP	3	571	Exp. ID	Point #
External Reset/Silence/Fire Drill switch trouble	pi Exp. ID	UT	Point #	UTNNXXPPPP	1	373	Exp. ID	Point #
External Reset/Silence/Fire Drill switch trouble restore	pi Exp. ID	UJ	Point #	UJNNXXPPPP	3	373	Exp. ID	Point #
Interlock switch alarm (Water Release Zone)	pi Exp. ID	FA	Point #	FANNXXPPPP	1	110	Exp. ID	Point #
Interlock switch alarm restore (Water Release Zone)	pi Exp. ID	FH	Point #	FHNNXXPPPP	3	110	Exp. ID	Point #
Interlock switch disabled	pi Exp. ID	FB	Point #	FBNNXXPPPP	1	571	Exp. ID	Point #
Interlock switch enabled	pi Exp. ID	FU	Point #	FUNNXXPPPP	3	571	Exp. ID	Point #
Interlock switch trouble (Water Release Zone)	pi Exp. ID	FT	Point #	FTNNXXPPPP	1	373	Exp. ID	Point #
Interlock switch trouble restore (Water Release Zone)	pi Exp. ID	FJ	Point #	FJNNXXPPPP	3	373	Exp. ID	Point #
LOC Mic Activated EVS Alarm	pi Exp. ID	QA	0	QANNXX0000	1	220	Exp. ID	000
LOC Mic Activated EVS Alarm Restore	pi Exp. ID	QH	0	QHNNXX0000	3	220	Exp. ID	000
LOC EVS # Alarm	pi Exp. ID	QA	Emergency #	QANNXXE000	1	220 + Emergency #	Exp. ID	000
LOC EVS # Alarm Restore	pi Exp. ID	QH	Emergency #	QHNNXXE000	3	220 + Emergency #	Exp. ID	000
Manual pull switch alarm	pi Exp. ID	FA	Point #	FANNXXPPPP	1	115	Exp. ID	Point #
Manual pull switch alarm restore	pi Exp. ID	FH	Point #	FHNNXXPPPP	3	115	Exp. ID	Point #
Manual pull switch disabled	pi Exp. ID	FB	Point #	FBNNXXPPPP	1	571	Exp. ID	Point #
Manual pull switch enabled	pi Exp. ID	FU	Point #	FUNNXXPPPP	3	571	Exp. ID	Point #
Manual pull switch trouble	pi Exp. ID	FT	Point #	FTNNXXPPPP	1	373	Exp. ID	Point #

Table 12-2: Reporting Formats Table

Event Description	SIA Reporting Format				Contact ID Reporting Format			
	SIA pi Modifier		SIA		Qualifier	Event Code	Group #	Contact #
Module ID # (If Any)	SIA Event Codes	Parameter	Fixed Length Format NN - panel ID XX- SBUS ID ZZZ- Zone # PPPP- Point # GGG- Group # E- Emergency # RRRR-Receiver #					
Manual pull switch trouble restore	pi Exp. ID	FJ	Point #	FJNNXXPPPP	3	373	Exp. ID	Point #
Manual release switch alarm (Water Release Zone)	pi Exp. ID	FA	Point #	FANNXXPPPP	1	110	Exp. ID	Point #
Manual release switch alarm restore (Water Release Zone)	pi Exp. ID	FH	Point #	FHNNXXPPPP	3	110	Exp. ID	Point #
Manual release switch disabled	pi Exp. ID	FB	Point #	FBNNXXPPPP	1	571	Exp. ID	Point #
Manual release switch enabled	pi Exp. ID	FU	Point #	FUNNXXPPPP	3	571	Exp. ID	Point #
Manual release switch trouble (Water Release Zone)	pi Exp. ID	FT	Point #	FTNNXXPPPP	1	373	Exp. ID	Point #
Manual release switch trouble restore (Water Release Zone)	pi Exp. ID	FJ	Point #	FJNNXXPPPP	3	373	Exp. ID	Point #
Notification output point disabled	pi Exp. ID	FB	Point #	FBNNXXPPPP	1	571	Exp. ID	Point #
Notification output point enabled	pi Exp. ID	FU	Point #	FUNNXXPPPP	3	571	Exp. ID	Point #
Notification output point trouble	pi Exp. ID	FT	Point #	FTNNXXPPPP	1	320	Exp. ID	Point #
Notification output point trouble restore	pi Exp. ID	FJ	Point #	FJNNXXPPPP	3	320	Exp. ID	Point #
Positive Alarm Sequence acknowledge switch disabled	pi Exp. ID	FB	Point #	FBNNXXPPPP	1	571	Exp. ID	Point #
Positive Alarm Sequence acknowledge switch enabled	pi Exp. ID	FU	Point #	FUNNXXPPPP	3	571	Exp. ID	Point #
Positive Alarm Sequence acknowledge switch trouble	pi Exp. ID	FT	Point #	FTNNXXPPPP	1	373	Exp. ID	Point #
Positive Alarm Sequence acknowledge switch trouble restore	pi Exp. ID	FJ	Point #	FJNNXXPPPP	3	373	Exp. ID	Point #
Status Point Trouble	pi Exp. ID	UT	Point #	UTNNXXPPPP	1	379	Exp. ID	Point #
Status Point Trouble Restored	pi Exp. ID	UJ	Point #	UJNNXXPPPP	3	379	Exp. ID	Point #
Status Point is Disabled	pi Exp. ID	UB	Point #	UBNNXXPPPP	1	580	Exp. ID	Point #
Status Point is Enabled	pi Exp. ID	UU	Point #	UUNNXXPPPP	3	580	Exp. ID	Point #
Supervisory/Tamper Alarm	pi Exp. ID	FS	Point #	FSNNXXPPPP	1	200	Exp. ID	Point #
Supervisory/Tamper Alarm Restore	pi Exp. ID	FR	Point #	FRNNXXPPPP	3	200	Exp. ID	Point #
Supervisory/Tamper point disabled	pi Exp. ID	FB	Point #	FBNNXXPPPP	1	571	Exp. ID	Point #
Supervisory/Tamper point enabled	pi Exp. ID	FU	Point #	FUNNXXPPPP	3	571	Exp. ID	Point #
Supervisory/Tamper point trouble	pi Exp. ID	FT	Point #	FTNNXXPPPP	1	373	Exp. ID	Point #
Supervisory/Tamper point trouble restore	pi Exp. ID	FJ	Point #	FJNNXXPPPP	3	373	Exp. ID	Point #

Table 12-2: Reporting Formats Table

Event Description	SIA Reporting Format			Contact ID Reporting Format				
	SIA pi Modifier	SIA	Parameter	Fixed Length Format NN - panel ID XX- SBUS ID ZZZ- Zone # PPPP- Point # GGG- Group # E- Emergency # RRRR-Receiver #	Qualifier	Event Code	Group #	Contact #
System-based AUX1 switch alarm	pi Exp. ID	UA	Point #	UANNXXPPPP	1	140	Exp. ID	Point #
System-based AUX1 switch alarm restore	pi Exp. ID	UH	Point #	UHNNXXPPPP	3	140	Exp. ID	Point #
System-based AUX1 switch disabled	pi Exp. ID	UB	Point #	UBNNXXPPPP	1	571	Exp. ID	Point #
System-based AUX1 switch enabled	pi Exp. ID	UU	Point #	UUNNXXPPPP	3	571	Exp. ID	Point #
System-based AUX1 switch trouble	pi Exp. ID	UT	Point #	UTNNXXPPPP	1	373	Exp. ID	Point #
System-based AUX1 switch trouble restore	pi Exp. ID	UJ	Point #	UJNNXXPPPP	3	373	Exp. ID	Point #
System-based AUX2 switch alarm	pi Exp. ID	UA	Point #	UANNXXPPPP	1	140	Exp. ID	Point #
System-based AUX2 switch alarm restore	pi Exp. ID	UH	Point #	UHNNXXPPPP	3	140	Exp. ID	Point #
System-based AUX2 switch disabled	pi Exp. ID	UB	Point #	UBNNXXPPPP	1	571	Exp. ID	Point #
System-based AUX2 switch enabled	pi Exp. ID	UU	Point #	UUNNXXPPPP	3	571	Exp. ID	Point #
System-based AUX2 switch trouble	pi Exp. ID	UT	Point #	UTNNXXPPPP	1	373	Exp. ID	Point #
System-based AUX2 switch trouble restore	pi Exp. ID	UJ	Point #	UJNNXXPPPP	3	373	Exp. ID	Point #
Voice Aux EVS 1 Point Alarm	pi Exp. ID	UA	(3PPP) PPP - Point #	UANNXX3PPP	1	171	Exp. ID	Point #
Voice Aux EVS 1 Point Alarm Restore	pi Exp. ID	UH	(3PPP) PPP - Point #	UHNNXX3PPP	3	171	Exp. ID	Point #
Voice Aux EVS 2 Point Alarm	pi Exp. ID	UA	(4PPP) PPP - Point #	UANNXX4PPP	1	172	Exp. ID	Point #
Voice Aux EVS 2 Point Alarm Restore	pi Exp. ID	UH	(4PPP) PPP - Point #	UHNNXX4PPP	3	172	Exp. ID	Point #
Voice Aux EVS 3 Point Alarm	pi Exp. ID	UA	(5PPP) PPP - Point #	UANNXX5PPP	1	173	Exp. ID	Point #
Voice Aux EVS 3 Point Alarm Restore	pi Exp. ID	UH	(5PPP) PPP - Point #	UHNNXX5PPP	3	173	Exp. ID	Point #

Table 12-2: Reporting Formats Table

Event Description	SIA Reporting Format				Contact ID Reporting Format			
	Module ID # (If Any)	SIA Event Codes	Parameter	Fixed Length Format NN - panel ID XX- SBUS ID ZZZ- Zone # PPPP- Point # GGG- Group # E- Emergency # RRRR-Receiver #	Qualifier	Event Code	Group #	Contact #
Voice Aux EVS 4 Point Alarm	pi Exp. ID	UA	(6PPP) PPP - Point #	UANNXX6PPP	1	174	Exp. ID	Point #
Voice Aux EVS 4 Point Alarm Restore	pi Exp. ID	UH	(6PPP) PPP - Point #	UHNNXX6PPP	3	174	Exp. ID	Point #
Voice Aux EVS Point Trouble	pi Exp. ID	UT	Point #	UTNNXXPPPP	1	379	Exp. ID	Point #
Voice Aux EVS Point Trouble Restore	pi Exp. ID	UJ	Point #	UJNNXXPPPP	3	379	Exp. ID	Point #
Voice Aux EVS Point Disabled	pi Exp. ID	UB	Point #	UBNNXXPPPP	1	580	Exp. ID	Point #
Voice Aux EVS Point Enabled	pi Exp. ID	UU	Point #	UUNNXXPPPP	3	580	Exp. ID	Point #
Voice Aux Status 1 Switch is Trouble	pi Exp. ID	UT	Point #	UTNNXXPPPP	1	379	Exp. ID	Point #
Voice Aux Status 1 Switch is Trouble Restored	pi Exp. ID	UJ	Point #	UJNNXXPPPP	3	379	Exp. ID	Point #
Voice Aux Status 1 Switch is Disabled	pi Exp. ID	UB	Point #	UBNXXPPPP	1	580	Exp. ID	Point #
Voice Aux Status 1 Switch is Enabled	pi Exp. ID	UU	Point #	UUNXXPPPP	3	580	Exp. ID	Point #
Voice Aux Status 2 Switch is Trouble	pi Exp. ID	UT	Point #	UTNNXXPPPP	1	379	Exp. ID	Point #
Voice Aux Status 2 Switch is Trouble Restored	pi Exp. ID	UJ	Point #	UJNNXXPPPP	3	379	Exp. ID	Point #
Voice Aux Status 2 Switch is Disabled	pi Exp. ID	UB	Point #	UBNNXXPPPP	1	580	Exp. ID	Point #
Voice Aux Status 2 Switch is Enabled	pi Exp. ID	UU	Point #	UUNNXXPPPP	3	580	Exp. ID	Point #
Water flow switch alarm	pi Exp. ID	SA	Point #	SANNXXPPPP	1	113	Exp. ID	Point #
Water flow switch alarm restore	pi Exp. ID	SH	Point #	SHNNXXPPPP	3	113	Exp. ID	Point #
Water flow switch disabled	pi Exp. ID	SB	Point #	SBNNXXPPPP	1	571	Exp. ID	Point #
Water flow switch enabled	pi Exp. ID	SU	Point #	SUNNXXPPPP	3	571	Exp. ID	Point #
Water flow switch trouble	pi Exp. ID	ST	Point #	STNNXXPPPP	1	373	Exp. ID	Point #
Water flow switch trouble restore	pi Exp. ID	SJ	Point #	SJNNXXPPPP	3	373	Exp. ID	Point #
Zone-based AUX1 switch alarm	pi Exp. ID	UA	Point #	UANNXXPPPP	1	140	Exp. ID	Point #
Zone-based AUX1 switch alarm restore	pi Exp. ID	UH	Point #	UHNNXXPPPP	3	140	Exp. ID	Point #
Zone-based AUX1 switch disabled	pi Exp. ID	UB	Point #	UBNNXXPPPP	1	571	Exp. ID	Point #

Table 12-2: Reporting Formats Table

Event Description	SIA Reporting Format			Contact ID Reporting Format				
	SIA pi Modifier	SIA Event Codes	SIA Parameter	Fixed Length Format NN - panel ID XX- SBUS ID ZZZ- Zone # PPPP- Point # GGG- Group # E- Emergency # RRRR-Receiver #	Qualifier	Event Code	Group #	Contact #
Zone-based AUX1 switch enabled	pi Exp. ID	UU	Point #	UUNNXXPPPP	3	571	Exp. ID	Point #
Zone-based AUX1 switch trouble	pi Exp. ID	UT	Point #	UTNNXXPPPP	1	373	Exp. ID	Point #
Zone-based AUX1 switch trouble restore	pi Exp. ID	UJ	Point #	UJNNXXPPPP	3	373	Exp. ID	Point #
Zone-based AUX2 switch alarm	pi Exp. ID	UA	Point #	UANNXXPPPP	1	140	Exp. ID	Point #
Zone-based AUX2 switch alarm restore	pi Exp. ID	UH	Point #	UHNNXXPPPP	3	140	Exp. ID	Point #
Zone-based AUX2 switch disabled	pi Exp. ID	UB	Point #	UBNNXXPPPP	1	571	Exp. ID	Point #
Zone-based AUX2 switch enabled	pi Exp. ID	UU	Point #	UUNNXXPPPP	3	571	Exp. ID	Point #
Zone-based AUX2 switch trouble	pi Exp. ID	UT	Point #	UTNNXXPPPP	1	373	Exp. ID	Point #
Zone-based AUX2 switch trouble restore	pi Exp. ID	UJ	Point #	UJNNXXPPPP	3	373	Exp. ID	Point #
System-based Wireless Gateway Trouble	pi Exp. ID	UT	Point #	UTNNXXPPPP	1	373	Exp. ID	Point #
System-based Wireless Gateway Trouble - restore	pi Exp. ID	UJ	Point #	UJNNXXPPPP	3	373	Exp. ID	Point #
Wireless Gateway Trouble	pi Exp. ID	UT	Point #	UTNNXXPPPP	1	373	Exp. ID	Point #
Wireless Gateway Trouble restore	pi Exp. ID	UJ	Point #	UJNNXXPPPP	3	373	Exp. ID	Point #

12.2 SIA / Panels PI Modifier Reporting:

Events are sent to the central station as a variable length string:

The event format is:

EEZZZZ

Where:

EE Event code (2 characters)

ZZZZ Event parameter (up to four digits – not zero filled)

1. The account number is sent using an account block that is separate from the event block
2. Multiple events can be sent within a single event block. Events are separated by a “/” character.
3. Event parameter can be either a zone, point or module number.

4. When reporting by point is enabled, the communicator uses a “pi” event to supersedes the actual point event to report the module the point is linked to.
5. Panel ID is not sent in the SIA event parameters.

For Example see Table 12-3:

Table 12-3: SIA- Panels - PI Modifier Reporting Examples

Event	Report Zone/ Point	Panel ID	Module	Zone ZZZZ	Point ZZZZ	Fields Sent	SIA Event Data
Fire Alarm-Zone	Zone	n/a	n/a97	15	n/a	EE-ZZ	FA15
Fire Alarm-Zone	Zone	n/a	n/a	05	n/a	EE-Z	FA5
Fire Alarm-Point	Point	n/a	01	n/a	123	EE-ZZ /EE-ZZZ	pi01/FA123
Fire Alarm-Point	Point	n/a	33	n/a	203	EE-ZZ /EE-ZZZ	pi11/FA203
Expander Trouble	n/a	n/a	11	n/a	n/a	EE-ZZ	ET11
Auto Test	n/a	n/a	n/a	n/a	n/a	EE-Z	RP0
Battery Trouble-Panel 32	n/a	n/a	98	n/a	n/a	EE-ZZ	YT98
Battery Trouble-Expander 18	n/a	n/a	18	n/a	n/a	EE-ZZ	YT18
SLC Loop Shorted	n/a	n/a	44	n/a	n/a	EE-ZZ	ET44
Program Begin Panel ID=32	n/a	n/a	n/a	n/a	n/a	EE-Z	LB0
Program Begin Panel ID=22	n/a	n/a	n/a	n/a	n/a	EE-Z	LB0
AC Power Loss - Panel 22	n/a	n/a	98	n/a	n/a	EE-Z	AT0
Fire Trouble	Point	n/a	97	n/a	200	EE-ZZ /EE-ZZZ	pi97/FT200
Fire Trouble	Zone	n/a	97	01	n/a	EE-Z	FT1
Fire Trouble-Nac	Point	n/a	98	n/a	Nac Circuit 7	EE-ZZ /EE-Z	pi98/FT7 Z=Pt. #
Fire Trouble-Nac	Zone	n/a	98	n/a	Nac Circuit 7	EE-ZZZ	FT400 ZZZ=OPG#

12.3 SIA – Panel Communicator:

(Differences/additional features are underlined>)

Events are sent to the Central Station Receiver as a fixed length string:

The event format is:

EEPPMMZZZZ

Where

EE Event code (2 characters)

PP Panel number (2 digits – Zero Filled) (valid range from 1 to 64)

MM Module number (2 digits – Zero Filled) (valid range from 1 to 98, typically Module information)

ZZZZ Event parameter (4 digits – Zero Filled) (typically Point, Zone or Circuit information)

1. The Event field will contain 10 digits including the 2 digit event code (EE), 2 digit panel ID (PP), 2 digit Module Number (MM) and a 4 digit Event Parameter (ZZZZ).
2. Based on the actual Event Code, the Module Number or Event Parameter fields might not contain pertinent information. In that case the field will contain zeros.
3. The account number is sent using an account block that is separate from the event block.
4. Multiple events can be sent within a single event block. Events are separated by a “/” character.
5. Event parameter can be a Zone, Point or Circuit Number.
6. “pi” modifier event is not used.
7. Panel can be set to report by either Point or Zone.

For examples see Table 12-4.

Table 12-4: SIA REPORTING EXAMPLES

Event	Report Zone/Point	Panel ID PP	Module MM	Zone ZZZZ	Point ZZZZ	Fields Sent	SIA Event Data
Fire Alarm-Zone	Zone	32	n/a	15	n/a	EE-PP-MM-ZZZZ	FA32000015
Fire Alarm-Zone	Zone	32	n/a	05	n/a	EE-PP-MM-ZZZZ	FA32000005
Fire Alarm-Point	Point	32	01	n/a	123	EE-PP-MM-ZZZZ	FA32010123
Fire Alarm-Point	Point	21	33	n/a	203	EE-PP-MM-ZZZZ	FA21330203
Expander Trouble	n/a	15	11	n/a	n/a	EE-PP-MM-ZZZZ	ET15110000
Auto Test	n/a	32	n/a	n/a	n/a	EE-PP-MM-ZZZZ	RP32000000
Battery Trouble-Panel 32	n/a	32	98	n/a	n/a	EE-PP-MM-ZZZZ	YT32980000
Battery Trouble-Expander 18	n/a	32	18	n/a	n/a	EE-PP-MM-ZZZZ	YT32180000
SLC Loop Shorted	n/a	01	44	n/a	n/a	EE-PP-MM-ZZZZ	ET01440000
Program Begin	n/a	32	n/a	n/a	n/a	EE-PP-MM-ZZZZ	LB32000000
Program Begin	n/a	22	n/a	n/a	n/a	EE-PP-MM-ZZZZ	LB22000000
AC Power Loss- Panel 22	n/a	22	98	n/a	n/a	EE-PP-MM-ZZZZ	AT22980000 MM = 00
Fire Trouble	Point	22	97	n/a	200	EE-PP-MM-ZZZZ	FT22970200
Fire Trouble	Zone	22	97	1	n/a	EE-PP-MM-ZZZZ	FT22970001 MM = 00
Fire Trouble-Nac	Point	22	98	n/a	Nac Circuit 7	EE-PP-MM-ZZZZ	FT22980007 ZZZZ=Pt. #
Fire Trouble-Nac	Zone	22	98	n/a	Nac Circuit 7	EE-PP-MM-ZZZZ	FT22980007 ZZZZ=OPG #

Section 13

Testing and Troubleshooting

13.1 Troubleshooting

This section of the manual offers suggestions for troubleshooting hardware problems. Please read this section if you encounter a problem when installing the control panel. If these suggestions do not solve your problem or if you encounter a problem that is not listed here, contact Honeywell Silent Knight Technical Support at 800-446-6444 for assistance.

13.2 Common Problems

Problem	Possible Cause / Suggested Actions
Trouble message "DBL ADDR" (Double Address) displays on LCD.	An address has been assigned to more than one detector. Correct the address following the procedure described in Section 7.9 if using SD devices or Section 7.7 if using SK devices.
Auxiliary power or notification circuits have incorrect polarity.	Correct polarity. For notification and auxiliary power circuits: When in alarm or powered, terminals labeled "X" are positive, terminals labeled "O" are negative.
SLC devices are not being recognized (trouble message "Missing" displays).	<p>Check hardware connections.</p> <p>If devices are physically connected, make sure wiring is correct (see Section 7.8 if using SD devices or Section 7.6 if using SK devices). For the main panel, the positive side of device must be connected to terminal 34; the negative side must be connected to Terminal 33. For 5815XL devices, make sure the device connects to the 5815XL via the SLC OUT terminals.</p> <p>There can be only one SLC loop on the main panel and on each 5815XL module. Do not connect devices to terminals labeled SLC IN.</p> <p>Make sure SLC devices have been addressed properly following the procedure described in Section 7.9 if using SD devices or Section 7.7 if using SK devices.</p> <p>For contact monitor modules, which are addressed using DIP switches, the DIP switch must be set to the correct address before power is applied to the SLC loop. If this procedure is not followed, the device will have an incorrect address.</p> <p>Make sure correct polarity has been observed for SLC device wiring. See Section 7.8 if using SD devices or 7.6 if using SK devices.</p>
SLC devices are not being recognized (trouble message "Missing" displays on the annunciator).	<p>Check that SLC loop impedance is within the required range.</p> <p>To measure impedance, use the following procedure:</p> <ol style="list-style-type: none"> 1. Disconnect both wires from the terminal block at the panel (SLC devices can remain connected). 2. Measure the impedance from positive to negative and from negative to positive. Both measurements should be greater than 500 K ohms. If the installation uses T-taps, test each T-tap individually. 3. Temporarily connect the positive wire to the negative wire of the SLC loop at the point farthest from the panel (SLC devices can remain connected). 4. Measure the impedance from positive to negative and from negative to positive wires that were disconnected from the panel in step 1. Both measurements must be less than 50 ohms.

Problem	Possible Cause / Suggested Actions
The panel indicates a ground fault trouble condition (trouble message "GROUND FAULT" displays).	<p>An earth ground fault occurs when the panel senses an unexpected flow of current from one or more of its terminals to the earth connection (Terminal 2). Isolate the wiring that is causing the fault by removing wiring connections one at a time until the earth fault is no longer present. Pause at least five seconds after removing a wire before removing the next one.</p> <p>The panel will also go into ground fault if a computer is connected to the panel via a serial cable attached to the panel's 9-pin connector. This is a correct method for on-site communication between a panel and a computer. Ignore the ground fault message in this case. The trouble will clear automatically when you disconnect the computer from the cable</p>
5815XL module that has been physically connected to the panel but is not being recognized.	<p>Check the status of the 5815XL green LED. If it flashes in the pattern .5 sec. on / .5 sec. off, it is likely that the 5815XL has not been added to the system through programming. JumpStart will add any 5815XLs connected to the panel. If you have already run JumpStart, 5815XLs can be added manually (see Section 9.2.2).</p> <p>Check that the correct ID for the 5815XL module has been set through the DIP switches. Assign ID#1 to the first 5815XL and ID#2 to the second 5815XL. See Section 4.13.1 for complete details.</p> <p>If the wiring between the 5815XL and the panel is correct, measure the voltage from 5815XL Terminal (+) to Terminal (-). Voltage should be in the range 27.2-27.4V when AC power is present.</p> <p>If the green LED is not flashing, the likely cause is incorrect wiring from between the 5815XL and the panel. See Section 4.8.1 for wiring details.</p>
6815 module that has been physically connected to the panel but is not being recognized.	<p>Check the status of the 6815 green LED. If it flashes in the pattern .5 sec. on / .5 sec. off, it is likely that the 6815 has not been added to the system through programming. JumpStart will add any 6815s connected to the panel. 6815s can be added manually (see Section 9.2.2).</p> <p>Check that the correct ID for the 6815 module has been set through the DIP switches. Assign ID#1 to the first 6815 and ID#2 to the second 6815. See Section 4.13.1 for complete details.</p> <p>If the wiring between the 6815 and the panel is correct, measure the voltage from 6815 Terminal (+) to Terminal (-). Voltage should be in the range 27.2-27.4V when AC power is present.</p> <p>If the green LED is not flashing, the likely cause is incorrect wiring from between the 6815 and the panel. See Section 4.8.1 for wiring details.</p>

13.3 Periodic Testing and Maintenance

To ensure proper and reliable operation, it is recommended that system inspection and testing be scheduled monthly or as required by national and/or local fire codes. Testing should be done by a qualified service representative if a malfunction is encountered.

Before testing:

1. Notify the fire department and/or central alarm receiving station.
2. Notify facility personnel of a test so that alarm sounding devices are ignored during the test period.
3. When necessary, activation of Notification Appliances can be prevented by the DISABLE function.

Testing:

1. Activate a input via an alarm initiating device and check that the correct outputs activate (Notification Appliances sound/flash, relays activate, alarm indicator lights). Reset system. Repeat for each alarm initiating device.

2. Momentarily open the following circuits one at a time and check for a trouble sign:
 - Notification Appliance Circuits
 - Initiating devices
3. If new batteries were installed, wait 48 hours before completing this step. Remove AC power, activate initiating device and check that:
 - The alarm indicator lights
 - All active Notification Appliances sound

Measure battery voltage while the Notification Appliances are sounding. Replace any battery with terminal voltage less than 85% of rating. Reapply AC power and reset the system.

13.4 Event History

The event history can be useful for tracking or recalling a trouble condition.

To view event history:

1. Press 3 to select Event History.
2. Press the up or down arrow key to view events in the history buffer.

13.5 Built-in Troubleshooting and Testing Tools

The fire control panel has several built-in testing and troubleshooting tools that can be utilized to save time while testing and troubleshooting points and SLC devices.

13.5.1 SLC Device Locator

SLC device locator can be used to locate a device on a SLC loop.

Follow these steps to locate a particular SLC device:

1. Select 2 for Point Functions from the Main Menu.
2. Select 4 for SLC Single Device Locator.

A message similar to the one shown in Figure 13-1 will display.

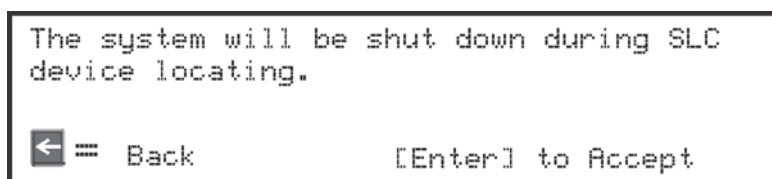

Figure 13-1 Shut Down Warning

3. Press the up or down arrow to toggle NO to YES then press ENTER.
 - If NO is chosen you will exit back to the Point Function menu.
 - If Yes is chosen the system will cease normal operation leaving the premise unprotected.
4. Select the SLC loop.
5. Enter the SLC address of the device you wish to locate.
 - The LED on the selected device will start flashing.
6. Press the left arrow to exit the SLC Device Locator.

Note: Once you exit, the system will resume normal operation.

13.5.2 SLC Multiple Locator

This feature is the same as SLC Device Locator, except you can locate up to 8 devices on a single search.

Follow these instructions to locate multiple SLC devices:

1. Select 2 (Point Functions) from the Main Menu.
2. Select 5 (SLC Multiple Device Locator).

A message similar to the one shown in Figure 13-2 will display.

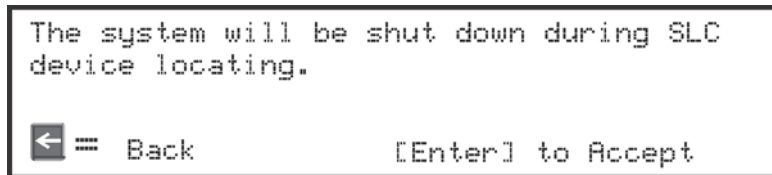

Figure 13-2 Shut Down Warning

3. Press the up or down arrow to toggle **NO** to **YES** then press ENTER.
If NO is chosen you will exit back to the Point Function menu.
If Yes is chosen the system will cease normal operation leaving the premise unprotected.
4. Select the SLC loop.
5. Enter up to 8 SLC addresses for the devices you wish to locate.
The LEDs on the selected devices will start flashing.
6. Press the left arrow to exit SLC Multiple Device Locator.

Note: Once you exit, the system will resume normal operation.

13.5.3 I/O Point Control

This feature allows you to toggle any output on or off and trip any input device. This can be useful to test a point's output mapping.

Follow these steps to control a I/O point:

1. Select 2 for Point Functions from the Main Menu.
2. Select 6 for I/O Point Control.
3. Select the module the point is on.
4. Use the up or down arrow to select the point you wish to test.
5. Press ENTER to generate an alarm for an input point or activate an output point.
6. To exit press the left arrow.

13.5.4 Earth Fault Resistance

Table 13-1 lists the earth fault resistance detection for each applicable terminal on the FACP.

Table 13-1: Earth Fault Resistance Values by Terminal

Function	Terminal Number	Terminal Label		Low Biased		High Biased	
		(Values in Ohms)		High Trip	High Restore	Low Trip	Low Restore
Flexput™ Notification Circuits	4	+	I/O 6	-	-	0	0
	5	-		0	0	-	-
	6	+	I/O 5	-	-	0	0
	7	-		0	0	-	-
Notification Circuits	8	+	NAC 4	-	-	0	0
	9	-		0	0	-	-
	10	+	NAC 3	-	-	0	0
	11	-		0	0	-	-
	12	+	NAC 2	-	-	0	0
	13	-		0	0	-	-
	14	+	NAC 1	-	-	0	0
15	-	0		0	-	-	
SBUS Communication	16	B	SBUS OUT	-	-	0	0
	17	A		-	-	0	0
SBUS Power	18	+		0	0	-	-
	19	-		-	-	0	0
SBUS Communication	20	B	SBUS IN	-	-	0	0
	21	A		-	-	0	0
SBUS Power	22	+		0	0	-	-
	23	-		-	-	0	0
SLC Terminals	33	SC-	SLC OUT	-	-	0	0
	34	S+		0	0	-	-
	35	SC-	SLC IN	-	-	0	0
	36	S+		0	0	-	-
EXT. COMM		B		-	-	0	0
		A		-	-	0	0
		+		0	0	-	-
		-		-	-	0	0

Section 14

Installation Records

This section of the manual is for you to use if you wish to track of how points, zones, and groups have been programmed.

14.1 Detector and Module Point Record

If installing SK SLC devices, use Table 14-1 to record detector points (up to 99 per SLC loop) installed on the on-board SLC loop and make a copy of Table 14-2 to record installed modules (up to 99 per SLC loop).

Table 14-1: Installation Record of Onboard Devices

Module	Addr	Zone / Group	Description	Module	Addr	Zone/ Group	Description
On-board	1			On-board	25		
On-board	2			On-board	26		
On-board	3			On-board	27		
On-board	4			On-board	28		
On-board	5			On-board	29		
On-board	6			On-board	30		
On-board	7			On-board	31		
On-board	8			On-board	32		
On-board	9			On-board	33		
On-board	10			On-board	34		
On-board	11			On-board	35		
On-board	12			On-board	36		
On-board	13			On-board	37		
On-board	14			On-board	38		
On-board	15			On-board	39		
On-board	16			On-board	40		
On-board	17			On-board	41		
On-board	18			On-board	42		
On-board	19			On-board	43		
On-board	20			On-board	44		
On-board	21			On-board	45		
On-board	22			On-board	46		
On-board	23			On-board	47		
On-board	24			On-board	48		
On-board	49			On-board	89		
On-board	50			On-board	90		
On-board	51			On-board	91		
On-board	52			On-board	92		
On-board	53			On-board	93		
On-board	54			On-board	94		
On-board	55			On-board	95		
On-board	56			On-board	96		

Table 14-1: Installation Record of Onboard Devices

Module	Addr	Zone / Group	Description	Module	Addr	Zone/ Group	Description
On-board	57			On-board	97		
On-board	58			On-board	98		
On-board	59			On-board	99		
On-board	60			On-board	100		
On-board	61			On-board	101		
On-board	62			On-board	102		
On-board	63			On-board	103		
On-board	64			On-board	104		
On-board	65			On-board	105		
On-board	66			On-board	106		
On-board	67			On-board	107		
On-board	68			On-board	108		
On-board	69			On-board	109		
On-board	70			On-board	110		
On-board	71			On-board	111		
On-board	72			On-board	112		
On-board	73			On-board	113		
On-board	74			On-board	114		
On-board	75			On-board	115		
On-board	76			On-board	116		
On-board	77			On-board	117		
On-board	78			On-board	118		
On-board	79			On-board	119		
On-board	80			On-board	120		
On-board	81			On-board	121		
On-board	82			On-board	122		
On-board	83			On-board	123		
On-board	84			On-board	124		
On-board	85			On-board	125		
On-board	86			On-board	126		
On-board	87			On-board	127		
On-board	88						

Additional SLC Devices

Use the table below to record devices installed on additional 5815XLs. Make a copy of this page if additional pages are needed.

Table 14-2: Installation Record of Devices Installed on 5815XLs

Module	Addr	Zone / Group	Description	Module	Addr	Zone/ Group	Description

Appendix A

Compatible Devices

A.1 Notification Appliances

For proper operation, you must use polarized devices with a model 7628 4.7k ohm EOL resistor on each loop. All supervised notification appliances used with the control panel must be polarized.

Note: Not all devices can use the Sync feature, be sure to check Table A-1 to ensure the devices you have chosen will work with this feature. This control is UL listed for panel wide Synchronization.

.Table A-1 below lists notification appliances compatible with the fire alarm control panel. Appliances which can be synchronized indicate the type of SYNC available in the columns marked Audio and Visual

Table A-1 Compatible Notification Appliances

Manufacturer	Model	Audio	Visual	Type
AMSECO	SH24W-153075	X	X	Horn/Strobe
	SAD24-153075		X	Strobe
	SAD24-75110		X	Strobe
	SL24W-75110		X	Strobe
	SL24C-3075110		X	Strobe
	SLB24-75		X	Strobe
	RSD24-153075		X	Strobe
	RSD24-75110		X	Strobe
	SH24W-75110	X	X	Horn/Strobe
	SH24W-3075110	X	X	Horn/Strobe
	SHB24-75	X	X	Horn/Strobe
	SCM24W-153075	X	X	Chimes/Strobe
	SCM24W-75110	X	X	Chimes/Strobe
	SCM24C-3075110	X	X	Chimes/Strobe
	SCM24C-177	X	X	Chimes/Strobe
	H24W	X		Horn
	H24R	X		Horn
	FCI	S2415-FC		X
S241575-FC			X	Strobe
S2430-FC			X	Strobe
130-3117C		X		Mini Horn
130-3147C		X		Mini Horn
BLV-6		X		Vibrating Bell
BLV-10		X		Vibrating Bell
BLVCH		X		Vibrating Chime
H12/24-FC		X		Horn
H12/24W-FC		X		Horn

Table A-1 Compatible Notification Appliances

Manufacturer	Model	Audio	Visual	Type	
FCI (cont.)	H12/24K-FC	X		Horn	
	HC12/24-FC	X		Horn	
	HC12/24W-FC	X		Horn	
	HC12/24K-FC	X		Horn	
	P2415-FC	X	X	Horn/Strobe	
	P2415W-FC	X	X	Horn/Strobe	
	P2415K-FC	X	X	Horn/Strobe	
	P241575-FC	X	X	Horn/Strobe	
	P241575W-FC	X	X	Horn/Strobe	
	P241575F-FC	X	X	Horn/Strobe	
	P241575K-FC	X	X	Horn/Strobe	
	P2430-FC	X	X	Horn/Strobe	
	P2430W-FC	X	X	Horn/Strobe	
	P2430K-FC	X	X	Horn/Strobe	
	P2475-FC	X	X	Horn/Strobe	
	P2475W-FC	X	X	Horn/Strobe	
	P2475K-FC	X	X	Horn/Strobe	
	P24110-FC	X	X	Horn/Strobe	
	P24110W-FC	X	X	Horn/Strobe	
	P24110K-FC	X	X	Horn/Strobe	
	S2430W-FC	X		Strobe	
	S2430K-FC	X		Strobe	
	S2475-FC	X		Strobe	
	S2475W-FC	X		Strobe	
	S2475K-FC	X		Strobe	
	S24110-FC	X		Strobe	
	S24110W-FC	X		Strobe	
	S24110K-FC	X		Strobe	
	Federal Signal	450	X		Horn
		VALS	X	X	Horn/Strobe

Table A-1 Compatible Notification Appliances

Manufacturer	Model	Audio	Visual	Type
Gentex	GEC-24-15	X	X	Horn/Strobe
	GEC-24-30	X	X	Horn/Strobe
	GEC-24-60	X	X	Horn/Strobe
	GEC-24-75	X	X	Horn/Strobe
	GEC-24-177	X	X	Horn/Strobe
	GX91	X		Mini Horn Steady Tone
	GX93	X		Mini Horn Temporal Tone
	HG124	X		Horn
	HS24-15	X	X	Horn/Strobe
	HS24-30	X	X	Horn/Strobe
	HS24-60	X	X	Horn/Strobe
	HS24-75	X	X	Horn/Strobe
	HS24-110	X	X	Horn/Strobe
	HS24-1575	X	X	Horn/Strobe
	GCC24	X	X	Multi Candella Horn/Strobe Ceiling Mount
	GCCR24	X	X	Multi Candella Horn/Strobe Ceiling Mount
	GCS24		X	Multi Candella Strobe Ceiling Mount
	GCSR24		X	Multi Candella Strobe Ceiling Mount
	GECR-24	X	X	Multi Candella Horn/Strobe
	GES24-15		X	Strobe
	GES24-30		X	Strobe
	GES24-60		X	Strobe
	GES24-75		X	Strobe
	GES24-110		X	Strobe
	GES24-15/75		X	Strobe
	GES24-177		X	Strobe
	GES3-24		X	Multi Candella Strobe
	GESR-24		X	Multi Candella Strobe
	GEH-24	X		Horn
	ST24-30		X	Strobe
	ST24-60		X	Strobe
	ST24-75		X	Strobe
	ST24-110		X	Strobe
	ST24-1575		X	Strobe
	WGEC24-75W	X	X	Weatherproof Horn/Strobe
	WGES24-75W		X	Weatherproof Strobe
	WGMS-24-X	X	X	Horn/Strobe
	GEC-24-110	X	X	Horn/Strobe
	GEC-24-15/75	X	X	Horn/Strobe

Table A-1 Compatible Notification Appliances

Manufacturer	Model	Audio	Visual	Type
System Sensor	CHR	X		Chime
	CHW	X		Chime
	CHSR	X	X	2-Wire Chime/Strobe
	CHSW	X	X	2-Wire Chime/Strobe
	HR	X	X	Horn
	HW		X	Horn
	HRK		X	Horn
	HWL		X	Horn WHT Wall 4x4
	HRL		X	Horn Red Wall 4x4
	HGRL		X	Horn Red Wall 2x4
	HGWL		X	Horn WHT Wall 2x4
	CHWL	X		Chime WHT Wall 4x4
	CHRL	X		Chime Red Wall 4x4
	CHSRL	X	X	Chime/Strobe Red Wall 4x4
	CHSWL	X	X	Chime/Strobe WHT Wall 4x4
	CHSCRL	X	X	Chime/Strobe Red Ceil 4x4
	CHSCWL	X	X	Chime/Strobe WHT Ceil 4x4
	P2R	X	X	2-Wire Horn/Strobe
	P2R-P	X	X	2-Wire Horn/Strobe
	PC2R	X	X	2-Wire Horn/Strobe
	PC2R-P	X	X	2-Wire Horn/Strobe
	P2RH	X	X	2-Wire Horn/Strobe High Candela
	P2RH-P	X	X	2-Wire Horn/Strobe High Candela
	PC2RH	X	X	2-Wire Horn/Strobe High Candela
	PC2RH-P	X	X	2-Wire Horn/Strobe High Candela
	P2W	X	X	2-Wire Horn/Strobe
	P2W-P	X	X	2-Wire Horn/Strobe
	PC2W	X	X	2-Wire Horn/Strobe
	PC2W-P	X	X	2-Wire Horn/Strobe
	P2WH	X	X	2-Wire Horn/Strobe High Candela
	P2WH-P	X	X	2-Wire Horn/Strobe High Candela
	PC2WH	X	X	2-Wire Horn/Strobe High Candela
	PC2WH-P	X	X	2-Wire Horn/Strobe High Candela
	P2RK	X	X	2-Wire Horn/Strobe
	PC2RK	X	X	2-Wire Horn/Strobe
	P2RHK	X	X	2-Wire Horn/Strobe High Candela
	PC2RHK	X	X	2-Wire Horn/Strobe High Candela
	P4R	X	X	4-Wire Horn/Strobe
	PC4R	X	X	4-Wire Horn/Strobe

Table A-1 Compatible Notification Appliances

Manufacturer	Model	Audio	Visual	Type
System Sensor (cont.)	P4RH	X	X	4-Wire Horn/Strobe High Candela
	P4W	X	X	4-Wire Horn/Strobe
	PC4W	X	X	4-Wire Horn/Strobe
	P4WH	X	X	4-Wire Horn/Strobe High Candela
	PC4WH	X	X	4-Wire Horn/Strobe High Candela
	P4RK	X	X	4-Wire Horn/Strobe
	PC4RK	X	X	4-Wire Horn/Strobe
	P4RHK	X	X	4-Wire Horn/Strobe High Candela
	PC4RHK	X	X	4-Wire Horn/Strobe High Candela
	PC4RH	X	X	4-Wire Horn/Strobe High Candela
	P2RL, P2RL-P, P2RL-SP*	X	X	Horn/Strobe 2W Red Wall 4x4
	P2WL, P2WL-P, P2WL-SP*	X	X	Horn/Strobe 2W WHT Wall 4x4
	PC2RL	X	X	Horn/Strobe 2W Red Ceil 4x4
	PC2WL	X	X	Horn/Strobe 2W WHT Ceil 4x4
	P2GRL	X	X	Horn/Strobe 2W Red Wall 2x4
	P2GWL	X	X	Horn/Strobe 2W WHT Wall 2x4
	SR		X	Strobe
	SR-P		X	Strobe
	SCR		X	Strobe
	SCR-P		X	Strobe
	SRH		X	Strobe High Candela
	SRH-P		X	Strobe High Candela
	SCRH		X	Strobe High Candela
	SCRH-P		X	Strobe High Candela
	SW		X	Strobe
	SW-P		X	Strobe
	SCW		X	Strobe
	SCW-P		X	Strobe
	SWH		X	Strobe High Candela
	SWH-P		X	Strobe High Candela
	SCWH		X	Strobe High Candela
	SCWH-P		X	Strobe High Candela
	SRK		X	Strobe
SCRK		X	Strobe	
SRHK		X	Strobe High Candela	
SCRHK		X	Strobe High Candela	
SRL, SRL-P, SRL-SP*		X	Strobe Red Wall 4x4	

Table A-1 Compatible Notification Appliances

Manufacturer	Model	Audio	Visual	Type
System Sensor (cont.)	SWL, SWL-P, SWL-ALERT SWL-CLR-ALERT*		X	Strobe White Wall 4x4
	SCRL		X	Strobe Red Ceil 4x4
	SCWL		X	Strobe White Ceil 4x4
	SCWL-CLR-ALERT		X	Strobe WHT Ceil CLR Lens 4x4
	SGRL		X	Strobe Red Wall 2x4
	SGWL		X	Strobe White Wall 2x4
	P2RH-LF	X	X	2-Wire Low Frequency Sounder Strobe
	P2WH-LF	X	X	2-Wire Low Frequency Sounder Strobe
	HR-LF	X		Low Frequency Sounder
	HW-LF	X		Low Frequency Sounder
	* P=Plain, ALERT=Pad Printing ALERT, SP=Fuego			
Wheelock	AH-12	X		Horn
	AH-24	X		Horn
	AH-12WP	X		Horn Weatherproof
	AH-24WP	X		Horn Weatherproof
	AMT-241575W	X	X	Multi-Tone Horn Strobe
	AMT-24MCW		X	Multi-Tone Horn Strobe
	AMT-241575W-NYC	X	X	Multi-Tone Horn Strobe
	AMT-12/24	X		Multi-tone Horn
	AMT-12/24 NYC	X		Multi-tone Horn
	AS-121575W		X	Horn/Strobe
	NH-12/24	X		Horn
	AS-241575W	X	X	Horn/Strobe
	AS-24MCC	X	X	Horn/Strobe
	AS-24MCCH	X	X	Horn/Strobe
	AS-24MCW	X	X	Horn/Strobe
	AS-24MCWH	X	X	Horn/Strobe
	ASWP-2475W	X	X	Horn/Strobe Weatherproof
	ASWP-2475C	X	X	Horn/Strobe Weatherproof
	ASWP-24MCWH	X	X	Horn/Strobe
	ASWP-24MCCH	X	X	Horn/Strobe
	CH-70	X		Chime
	CH-90	X		Chime
	CH70-241575W		X	Chime/Strobe
	CH70-24MCW		X	Chime/Strobe
	CH70-24MCWH		X	Chime/Strobe
	CH90-24MCC		X	Chime/Strobe
	CH90-24MCCH		X	Chime/Strobe
	HS-24	X		Horn
	HS4-241575W	X	X	Horn/Strobe

Table A-1 Compatible Notification Appliances

Manufacturer	Model	Audio	Visual	Type
Wheelock (cont.)	HS4-24MCW	X	X	Horn/Strobe
	HS4-24MCWH	X	X	Horn/Strobe
	HS4-24MCC	X	X	Horn/Strobe
	MIZ-24S	X	X	Mini Horn Strobe
	MT-121575W		X	Multi-tone Horn Strobe
	MT-241575W	X	X	Multi-tone Horn Strobe
	MT-24MCW		X	Multi-tone Horn Strobe
	MTWP-2475W		X	Multi-tone Horn Strobe
	MTWP-2475C		X	Multi-tone Horn Strobe
	MTG-121575W	X	X	Multi-tone Horn Strobe
	MTR-121575W	X	X	Multi-tone Horn Strobe
	MTWPA-2475W	X	X	Multi-tone Horn Strobe
	MTWPB-2475W	X	X	Multi-tone Horn Strobe
	MTWPG-2475W	X	X	Multi-tone Horn Strobe
	MTWPR-2475W	X	X	Multi-tone Horn Strobe
	MTWPA-24MCCH	X	X	Multi-tone Horn Strobe
	ZNH	X		Horn
	NS-121575W	X	X	Horn/Strobe
	NS-241575W	X	X	Horn/Strobe
	NS-24MCW	X	X	Horn/Strobe
	NS-24MCC	X	X	Horn/Strobe
	NS-24MCCH	X	X	Horn/Strobe
	ZNS-MCW	X	X	Horn/Strobe
	ZNS-MCWH	X	X	Horn/Strobe
	ZNS-24MCC	X	X	Horn/Strobe
	ZNS-24MCCH	X	X	Horn/Strobe
	RSS-121575W		X	Strobe
	RSS-241575W		X	Strobe
	RSS-24MCC		X	Strobe
	RSS-24MCCR		X	Strobe
	RSS-24MCCH		X	Strobe
	RSS-24MCCHR		X	Strobe
	RSS-24MCW		X	Strobe
	RSS-24MCWH		X	Strobe
	RSSP-121575W		X	Strobe
	RSSP-241575W		X	Strobe
	RSSR-2415W		X	Strobe
	RSSR-2415C		X	Strobe
	RSSR-2475W		X	Strobe
	RSSR-2475C		X	Strobe

Table A-1 Compatible Notification Appliances

Manufacturer	Model	Audio	Visual	Type
Wheelock (cont.)	RSSR-24110C		X	Strobe
	RSSA-24110W		X	Strobe
	RSSB-24110W		X	Strobe
	RSSG-24110W		X	Strobe
	RSSR-24110W		X	Strobe
	RSSA-24MCC		X	Multi Candela Strobe
	RSSB-24MCC		X	Multi Candela Strobe
	RSSG-24MCC		X	Multi Candela Strobe
	RSSR-24MCC		X	Multi Candela Strobe
	RSSWPA-2475W		X	Strobe Weatherproof
	RSSWPA-24MCCH		X	Strobe Weatherproof
	RSSWPG-24MCCH		X	Strobe Weatherproof
	RSSWPR-24MCCH		X	Strobe Weatherproof
	RSSWP-2475W		X	Strobe Weatherproof
	RSSWP-2475C		X	Strobe Weatherproof
	RSSWP-24MCWH		X	Strobe Weatherproof
	ZRS-MCWH		X	Strobe
	ZRS-24MCC		X	Strobe
	ZRS-24MCCH		X	Strobe
	MB-G6-24			Motor Bell
	MB-G10-24			Motor Bell
	MB-G6-12			Motor Bell
	MB-G10-12			Motor Bell
	MIZ-24-R			Mini Horn
	MT-12/24-R	X	X	Multi-tone Horn
	MT4-12/24	X	X	Multi-tone Horn
	ZRS-MCW		X	Strobe
	MTWPR-24MCCH	X	X	Multi-tone Horn Strobe
	NH-12/24R	X		Horn
	HSR		X	Horn Strobe
	HSW		X	Horn Strobe
	STR		X	Strobe
	STW		X	Strobe
HNR		X	Horn	
HNW		X	Horn	

A.2 Two Wire Detectors

Table A-2 lists two-wire smoke detectors that are compatible with the fire control panel. The table is organized by manufacturer. The columns show the number of detectors per loop that can be used.

	6820/EVS
Identifier	24H
Operating voltage Range	17.1 - 27.3 VDC

Note: The maximum number of smoke detectors per zone is determined by both the current draw and the impedance of the smoke detector. If too many smoke detectors are used on any zone, false alarms could occur.

Do not mix different models of detectors on any zone; false alarms could occur.

Control unit Smoke Reset Time must be programmed for a number greater than or equal to the maximum reset time of the smoke detector.

Table A-2: Compatible Two-Wire Smoke Detectors

Manufacturer	Model Name or Number (Base model name or number in parenthesis.)	Compatibility ID		# per Loop
		Head	Base	
Apollo	55000-350 (45681-200)	55000-350	45681-200	15 / loop
	55000-250 (45681-200)	55000-250	45681-200	24 / loop
	55000-225	55000-225	45681-255, 256	15 / loop for Ion Detectors
	55000-226	55000-226	45681-200, 220, 232, 251, 252	15 / loop for Photo Electric Detectors
	55000-227	55000-227		
	55000-325	55000-325		
	55000-326	55000-326		
	55000-327	55000-327		
	55000-328	55000-328		
Hochiki	SLR-24	HD-3	HSC-220R(HB-72) NS6-220 OR NS4-220 (HB-3)	15 / loop
	SLR-24H			
	SLR-24V			
	SLR-835	HD-3		14 / loop
	SLR-835H	HD-5		

Table A-2: Compatible Two-Wire Smoke Detectors

Manufacturer	Model Name or Number <i>(Base model name or number in parenthesis.)</i>	Compatibility ID		# per Loop
		Head	Base	
System Sensor	1400	A	N/A	16 / loop
	1451 (B401B)	A	N/A	16 / loop
	2100	A	N/A	20 / loop
	2100T	A	N/A	20 / loop
	2151 (B401)	A	N/A	16 / loop
	2151T (B401)	A	N/A	16 / loop
	2400	A	N/A	16 / loop
	2400TH	A	N/A	16 / loop
	2451 (B401B)	A	N/A	16 / loop
	2451TH (B401B)	A	N/A	16 / loop
	2W-B	A	N/A	20 / loop
	2WT-B	A	N/A	20 / loop
	2WTA-B	A	N/A	20 / loop
	2WTR-B	A	N/A	20 / loop

A.3 Four-Wire Smoke Detectors/Devices (UL Listed)

Table A-3 Compatible Four-Wire Smoke Detectors

Smoke Detector/Base	Detector Type	Max Standby Current (mA)	Alarm Current (mA)
Fenwal CPD-7021 (w/70-201000-005 Base)	Ionization	0.10	*
Fenwal PSD-7125	Photoelectric	0.10	*
Fenwal PSD-7126 (w/70-201000-005 Base)	Photoelectric	0.10	*
Fire-Lite BLP-12-4W	Base	*	*
Gentex 824	Photoelectric	0.50	*
Gentex 824T	Photoelectric	0.50	*
Gentex 824CP	Photoelectric	0.50	*
Gentex 824CPT	Photoelectric	0.50	*
Hochiki HSC-4R	Base	*	*
Hochiki SPB-24	Projected Beam	0.25	*
System Sensor B112LP	Base	0.12	36
System Sensor B114LP	Base	*	*
System Sensor B404B	Base	*	*
System Sensor DH100ACDC	Photoelectric	0.15	0.70
System Sensor DH100ACDCLP	Photoelectric	0.15	0.70
System Sensor DH100ACDCLWP	Photoelectric	0.15	0.70
System Sensor DH400ACDCI	Ionization Duct	25	95
System Sensor DH400ACDCP	Photoelectric Duct	25	95
System Sensor 1112/24/D	Ionization	0.05	50
System Sensor 1424	Ionization	0.10	41

Smoke Detector/Base	Detector Type	Max Standby Current (mA)	Alarm Current (mA)
System Sensor 1451 (w/B402B Base)	Ionization	0.10	39
System Sensor 2112/24ATR	Photoelectric	0.50	60/70
System Sensor 2112/24AITR	Photoelectric	0.50	60/70
System Sensor 2112/24/D	Photoelectric	0.05	50
System Sensor 2112/24R	Photoelectric	0.50	60/70
System Sensor 2112/24TR	Photoelectric	0.50	60/70
System Sensor 2112/24T/D	Photoelectric w/135° Thermal	0.05	50
System Sensor 2112/24TSRB	Photoelectric w/135° Thermal Supervisory Relay	15	45
System Sensor 2312/24TB	Photoelectric	0.12	50
System Sensor 2412 (12 volt)	Photoelectric	0.12	77
System Sensor 2412AT (12 volt)	Photoelectric	0.12	58
System Sensor 2412TH (12 volt)	Photoelectric	0.12	77
System Sensor 2424	Photoelectric	0.10	41
System Sensor 2424TH	Photoelectric	0.10	41
System Sensor 2451	Photoelectric	0.10	39
System Sensor 2451TH (with/B402B Base)	Photoelectric	0.10	39
System Sensor 2W-MOD	Loop Test/Maintenance Mod.	30	50
System Sensor 4W-B (12/24 Volt)	Photoelectric I ³	.05	23
System Sensor 4WT-B (12/24 Volt)	Photoelectric I ³ w/Therm	.05	23
System Sensor 4WTA-B (12/24 Volt)	I ³ Photo w/ Therm Sounder	.05	35
System Sensor 4WTR-B (12/24 Volt)	I ³ Photo w/ Therm/Relay	.05	35
System Sensor 4WTAR-B (12/24 Volt)	I ³ Photo w/ Therm/ Sounder/Relay	.05	50
System Sensor 4WITAR-B (12/24 Volt)	I ³ Photo w/ Isolated Therm/ Sounder/Relay	.05	50
System Sensor 2W-MOD2	I ³ Loop Test/Maintenance Mod.	.05	*
System Sensor RRS-MOD	I ³ Reversing Relay/Sync Module	.05	*
System Sensor 6424	Projected Beam	10	28.4
System Sensor Beam 1224(S)	Projected Beam	17	38.5
* Contact manufacturer for current draws			

A.4 Door Holders (UL Listed)

Table A-4 lists door holders that are compatible with the fire control panel.

Table A-4 Compatible Door Holders

Manufacturer	Model	Type	Current (mA)
Edwards	DH150A	Floor Mount	96
Edwards	DH154A	Flush Mount	96
Edwards	DH158A	Surface Mount	96
Rixon Firemark	FM-980	Floor Mount, single	68
Rixon Firemark	FM-996	Surface Wiring	68
Rixon Firemark	FM-998	Concealed Wiring	68

A.5 Relays (UL Listed)

Table A-5 lists relays compatible with the fire control panel.

Table A-5 Compatible Relays

Manufacturer	Model	Current (mA)
Air Products & Controls, LTD	MR-101/C	15
	MR-201/C	35
	PAM-1	15
	PAM-2	15
	PAM-SD	15
System Sensor	A77-716B	20
	PR-1	15
	PR-2	30
	PR-3	30
	EOLR-1	30
	R-10T	23
	R-14T	23
	R-20T	40
	R-24T	40
	R-10E	23
	R-14E	23
	R-20E	40
	R-24E	40

A.6 Compatible 520Hz Signaling Speakers

Table A-6 520Hz Speakers

Model Number	Description
System Sensor Model Number	Description
SPR	Wall High-Fidelity Speaker, Red
SPW	Wall High-Fidelity Speaker, White
SPCR	Ceiling High-Fidelity Speaker, Red
SPCW	Ceiling High-Fidelity Speaker, White
SPSR	Wall High-Fidelity Speaker Strobe, Red
SPSRH	Wall High-Fidelity Speaker Strobe, High Candela, Red
SPSW	Wall High-Fidelity Speaker Strobe, White
SPSCR	Ceiling High-Fidelity Speaker Strobe, Red
SPSCW	Ceiling High-Fidelity Speaker Strobe, White
SPSCWH	Ceiling High-Fidelity Speaker Strobe, High Candela, White
SPSCRH	Ceiling High-Fidelity Speaker Strobe, High Candela, Red
SPSCW-CLR-ALERT	Ceiling High-Fidelity Speaker Strobe, Clear Lens, ALERT, White
SPSCW-P	Ceiling High-Fidelity Speaker Strobe, Plain, White
SPSCWH-P	Ceiling High-Fidelity Speaker Strobe, High Candela, Plain, White
SPSR-P	Wall High-Fidelity Speaker Strobe, Plain, Red
SPSRH-P	Wall High-Fidelity Speaker Strobe, High Candela, Plain, Red
SPSCWH-P	Ceiling High-Fidelity Speaker Strobe, High Candela, Plain, White
SPSW-ALERT	Wall High-Fidelity Speaker Strobe, Amber Lens, ALERT, White
SPSW-CLR-ALERT	Wall High-Fidelity Speaker Strobe, Clear Lens, ALERT, White
SPSW-P	Wall High-Fidelity Speaker Strobe, Plain, Red
SPSWH	Wall High-Fidelity Speaker Strobe, High Candela, White
SPSWH-P	Wall High-Fidelity Speaker Strobe, High Candela, Plain, Red
SPCRL	Ceiling High-Fidelity Speaker, Red
SPCWL	Ceiling High-Fidelity Speaker, White
SPRL	Wall High-Fidelity Speaker, Red
SPWL	Wall High-Fidelity Speaker, White
SPSCRL	Ceiling High-Fidelity Speaker Strobe, Red
SPSCWL	Ceiling High-Fidelity Speaker Strobe, White
SPSRL	Wall High-Fidelity Speaker Strobe, Red
SPSRL-SP	Wall High-Fidelity Speaker Strobe, FUEGO
SPSWL	Wall High-Fidelity Speaker Strobe, White
SPSCWL-P	Ceiling High-Fidelity Speaker Strobe, Standard, White, Plain
SPSRL-P	Wall High-Fidelity Speaker Strobe, Standard, Red, Plain
SPSWL-P	Wall High-Fidelity Speaker Strobe, Standard, White, Plain
SPSCWL-CLR-ALERT	Ceiling High-Fidelity Speaker Strobe, Clear Lens, Standard, White, ALERT
SPSWL-ALERT	Wall High-Fidelity Speaker Strobe, Amber Lens, ALERT, White
SPSWL-CLR-ALERT	Wall High-Fidelity Speaker Strobe, Clear Lens, Standard, White, ALERT
*F=FIRE, P=PLAIN, AL=ALERT, AG=AGENT, EV=EVAC, SP=FUEGO, PG=FOGO	

A.7 Compatible 520Hz Low Frequency Bases

Table A-7 Low Frequency Bases

Model Number	Description
B200S-LF	Low Frequency Intelligent Sounder Base
B200SR-LF	Low Frequency Intelligent Sounder Base

Appendix B

Editing Text Using the Built-In Programmer

This section contains tables of programmable characters that may be used for device, module, site, template, group, and zone names or phone numbers. T9 style editing is used.

B.1 Characters Used for Editing Text

Table B-1 lists the available characters and their associated numeric designator. When programming:

1. Use the Up or Down arrow key to scroll to the mode wanted.
2. Press the number shown in Table B-1 until the character wanted is shown.
3. Arrow left and right for position, and press enter to accept.

Table B-1: Character Table

Lower Case Letters							
abc	1	def	2	ghi	3	jkl	4
mno	5	pqr	6	stu	7	vwx	8
yz	9	Spc	0				
Upper Case Letters							
ABC	1	DEF	2	GHI	3	JKL	4
MNO	5	PQR	6	STU	7	VWX	8
YZ	9	Spc	0				
Numbers and Special Characters							
1 []	1	2 ()	2	3 . ,	3	4 : ;	4
5 ' "	5	6 ? !	6	7 ' /	7	8 - +	8
9 = -	9	0	0	* & @	*	# \$	#

B.2 Example Name Edit

1. Press up or down to select upper case letters mode, Press 2 until “F” appears.
2. Press up or down to change mode to lower case letters, Press 3 until “i” appears.
3. Press 6 until “r” appears.
4. Press 2 until “e” appears.
5. Press 0 to space, then continue to next word using the same process.
6. Press ENTER to accept.

Note: After three seconds of no change, letter will automatically be accepted. Also pressing next number will automatically accept previous choice.

```
<Module Name>          Enter: Accept
Fire Door_____
 1[abc] 2[def] 3[ghi] 4[jkl] 5[mno]
 6[pqr] 7[stu] 8[vwx] 9[yz ] 0[Spc]
```

Figure B-1 Edit Name Example

Appendix C

Expanded Receiver/Panel Relationship

The available receiver number will correspond with what panel number you entered. Receiver numbers are populated based on panel number and audited to allow only the 4 appropriate receivers. See section 6.2.6.3 on page 5.

Table C-1 Receiver/panel relationship

Panel	Available receiver numbers			
1	1	2	3	4
2	5	6	7	8
3	9	10	11	12
4	13	14	15	16
5	17	18	19	20
6	21	22	23	24
7	25	26	27	28
8	29	30	31	32
9	33	34	35	36
10	37	38	39	40
11	41	42	43	44
12	45	46	47	48
13	49	50	51	52
14	53	54	55	56
15	57	58	59	60
16	61	62	63	64
17	65	66	67	68

Appendix D

Cadence Patterns

The cadence patterns shown in Appendix D are available for use with the control panel.





#	Name	Pattern Description																										
00	Constant	Continuous sound Note: This is the only pattern that can be used for relay circuits. The system will override any other choice.																										
01	March Code	 .5 sec on .5 sec off																										
02	ANSI 3.41																											
03	Single Stroke																											
04	California																											
05 ⋮ 16	Zone Coded	<table border="1" data-bbox="373 1081 600 1407"> <thead> <tr> <th>Pattern#</th> <th>Zone</th> </tr> </thead> <tbody> <tr><td>5</td><td>Zone 1</td></tr> <tr><td>6</td><td>Zone 2</td></tr> <tr><td>7</td><td>Zone 3</td></tr> <tr><td>8</td><td>Zone 4</td></tr> <tr><td>9</td><td>Zone 5</td></tr> <tr><td>10</td><td>Zone 6</td></tr> <tr><td>11</td><td>Zone 7</td></tr> <tr><td>12</td><td>Zone 8</td></tr> <tr><td>13</td><td>Custom 1</td></tr> <tr><td>14</td><td>Custom 2</td></tr> <tr><td>15</td><td>Custom 3</td></tr> <tr><td>16</td><td>Custom 4</td></tr> </tbody> </table>  → This pattern multiplied by # of zone in alarm, followed by 3 seconds off. EXAMPLE: Pattern 06, Zone 2 coded 	Pattern#	Zone	5	Zone 1	6	Zone 2	7	Zone 3	8	Zone 4	9	Zone 5	10	Zone 6	11	Zone 7	12	Zone 8	13	Custom 1	14	Custom 2	15	Custom 3	16	Custom 4
Pattern#	Zone																											
5	Zone 1																											
6	Zone 2																											
7	Zone 3																											
8	Zone 4																											
9	Zone 5																											
10	Zone 6																											
11	Zone 7																											
12	Zone 8																											
13	Custom 1																											
14	Custom 2																											
15	Custom 3																											
16	Custom 4																											
17 ⋮ 21	<table border="1" data-bbox="373 1428 649 1543"> <thead> <tr> <th>Pattern #</th> <th>Sync Type</th> </tr> </thead> <tbody> <tr><td>17</td><td>Faraday- not allowed</td></tr> <tr><td>18</td><td>Gentex</td></tr> <tr><td>19</td><td>System Sensor</td></tr> <tr><td>20</td><td>Wheelock</td></tr> <tr><td>21</td><td>Amesco</td></tr> </tbody> </table>	Pattern #	Sync Type	17	Faraday- not allowed	18	Gentex	19	System Sensor	20	Wheelock	21	Amesco	These outputs provide synchronization for AMSECO, Gentex, System Sensor, or Wheelock synchronized appliances.														
Pattern #	Sync Type																											
17	Faraday- not allowed																											
18	Gentex																											
19	System Sensor																											
20	Wheelock																											
21	Amesco																											
22	Power Isolated	Disconnected, no voltage at terminals																										
23	Temporal 4																											

Figure C-1 Cadence Patterns Available with the Control Panel

Panel Security

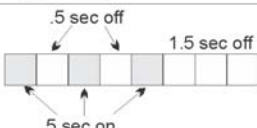
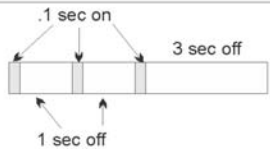
Panel installation / maintenance security checklist

System Description: _____

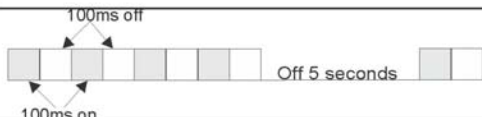
System Location: _____

Installer: _____ Date: _____

Complete the following Cyber security tasks for each panel Install

- Install the panel in a secure location considering both software and hardware vulnerabilities.
- Change the default password to a unique password
- Securely configure networks and firewalls
- Assess security risks
- Develop a Disaster and Recovery Plan
- Develop a Backup and Recovery Strategy
- Install, configure and keep anti virus software updated on all computers which access the panel
- Keep operating system updated on all computers which access the panel
- Deliver all required system information upon delivery to the system owner
- Train end-users on security maintenance tasks upon system delivery
- For decommissioning, dispose of data securely.
- Ensure the Ethernet cable is removed from the FACP when not being utilized for configuration

Security and Data Protection

Communication Security - Level 1

Stored Data Security - Level 0

Physical Security - Level 1

Access Control Security - Level 1

Honeywell Fire Product Warranty and Return Policy

General Terms and Conditions

- All new fire products manufactured by Honeywell have a limited warranty period of 36 months from the date of manufacture against defects in materials and workmanship. See limited warranty statement for details.
- This limited warranty does not apply to those products that are damaged due to misuse, abuse, negligence, exposure to adverse environmental conditions, or have been modified in any manner whatsoever.

Repair and RMA Procedure

- All products that are returned to Honeywell for credit or repair require a RMA (Return Authorization) number. Call Customer Service at 800-328-0103 or 203-484-7161 between 8:00 A.M. and 5:00 P.M. EST, Monday through Friday to obtain a return authorization number.
- Honeywell Silent Knight and Farenhyt Series Technical Support is available at 800-446-6444 between 8:00 A.M. and 5:00 P.M. CST, Monday through Friday.
- All returns for credit are subject to inspection and testing at the factory before actual determination is made to allow credit.
- RMA number must be prominently displayed on the outside of the shipping box. See return address example under Advanced Replacement Policy.
- Included with each return should be: a packing slip that has the RMA number, a content list, and a detailed description of the problem.
- All products returned by Honeywell must be sent freight pre-paid. After the product is processed, Honeywell will pay for shipping product back to customer via UPS ground.
- Return the Honeywell Silent Knight product circuit board only. Products that are returned in cabinets will be charged an additional \$50 to cover the extra shipping and handling costs over board only returns. **Do not return batteries.** Honeywell has the authority to determine if a product is repairable. Products that are deemed un-repairable will be returned to the customer.
- Product that is returned that has a board date code more than 36 months from date of manufacture will be repaired and the customer will be assessed the standard Honeywell Silent Knight repair charge for that model.

Advanced Replacement Policy

- Honeywell Silent Knight and Farenhyt Series offers an option of advance replacement for fire product printed circuit boards that fail during the first 6 months of the warranty period. These items must be returned with transportation charges prepaid and must be accompanied by a return authorization.
- For advance replacement of a defective board, contact your local Honeywell Silent Knight distributor or call Honeywell Silent Knight at 800-328-0103 to obtain a RMA (Return Authorization) number and request advanced replacement.
- A new or refurbished board will be shipped to the customer. The customer will initially be billed for the replacement board but a credit will be issued after the repairable board is received at Honeywell Silent Knight. All returned products must comply with the guidelines described under “General Terms and Conditions” and “Repair and RMA Procedure”.
- The defective board must be returned within 30 days of shipment of replacement board for customer to receive credit. No credit will be issued if the returned board was damaged due to misuse or abuse.

- Repairs and returns should be sent to:
Honeywell Fire Systems
Attn: Repair Department / RA Number _____
12 Clintonville Road
Northford, CT 06472 USA

Manufacturer Warranties and Limitation of Liability

Manufacturer Warranties. Subject to the limitations set forth herein, Manufacturer warrants that the Products manufactured by it in its Northford, Connecticut facility and sold by it to its authorized Distributors shall be free, under normal use and service, from defects in material and workmanship for a period of thirty six months (36) months from the date of manufacture (effective Jan. 1, 2009). The Products manufactured and sold by Manufacturer are date stamped at the time of production. Manufacturer does not warrant Products that are not manufactured by it in its Northford, Connecticut facility but assigns to its Distributor, to extent possible, any warranty offered by the manufacturer of such product. This warranty shall be void if a Product is altered, service repaired by anyone other than Manufacturer or its authorized Distributors. This warranty shall also be void if there is a failure to maintain the Products and the systems in which they operate in proper working conditions.

MANUFACTURER MAKES NO FURTHER WARRANTIES, AND DISCLAIMS ANY AND ALL OTHER WARRANTIES, EITHER EXPRESSED OR IMPLIED, WITH RESPECT TO THE PRODUCTS, TRADEMARKS, PROGRAMS AND SERVICES RENDERED BY MANUFACTURER INCLUDING WITHOUT LIMITATION, INFRINGEMENT, TITLE, MERCHANTABILITY, OR FITNESS FOR ANY PARTICULAR PURPOSE. MANUFACTURER SHALL NOT BE LIABLE FOR ANY PERSONAL INJURY OR DEATH WHICH MAY ARISE IN THE COURSE OF, OR AS A RESULT OF, PERSONAL, COMMERCIAL OR INDUSTRIAL USES OF ITS PRODUCTS.

This document constitutes the only warranty made by Manufacturer with respect to its products and replaces all previous warranties and is the only warranty made by Manufacturer. No increase or alteration, written or verbal, of the obligation of this warranty is authorized. Manufacturer does not represent that its products will prevent any loss by fire or otherwise.

Warranty Claims. Manufacturer shall replace or repair, at Manufacturer's discretion, each part returned by its authorized Distributor and acknowledged by Manufacturer to be defective, provided that such part shall have been returned to Manufacturer with all charges prepaid and the authorized Distributor has completed Manufacturer's Return Material Authorization form. The replacement part shall come from Manufacturer's stock and may be new or refurbished. THE FOREGOING IS DISTRIBUTOR'S SOLE AND EXCLUSIVE REMEDY IN THE EVENT OF A WARRANTY CLAIM.

Warn-HL-08-2009.fm



6820 Basic Operating Instructions

These instructions must be framed and displayed next to the 6820 panel in accordance with NFPA 72 fire code for Local Protected Fire Alarm Systems.

Operation	Keystrokes
Silence Alarms and Troubles	Press SILENCE then rotate the key or enter a code if prompted. Silence LED will light.
Reset alarms	Press RESET then rotate the key or enter a code if prompted.
View Alarms, Supervisories and Troubles	For each type of condition press the Up or Down button associated for Alarms, Supervisories, or Troubles. <div style="display: flex; justify-content: space-around; margin-top: 10px;"> <div style="border: 1px solid black; padding: 5px; text-align: center;"> <pre>FIRE: ALRM SUPR TRBL CO: ALRM SYS: TRBL</pre> </div> <div style="border: 1px solid black; padding: 5px; text-align: center;"> <pre>FIRE: ALARM Waterflow Sw Zone_1 1 of 1 Info></pre> </div> </div>
View status of point	<ol style="list-style-type: none"> 1. Press Enter to access the main menu. 2. Press 2 for Point Functions. 3. Select the module the device is located on by using the Up or Down button. Then press ENTER. 4. Enter the point number.
Conduct a fire drill	<ol style="list-style-type: none"> 1. Press ENTER to access Main Menu. 2. Then Press 1 to select System Tests. 3. Press 1 to select Fire Drill. 4. Press ENTER to start the fire drill. 5. Press ENTER to end the fire drill.
Check Detector Sensitivity	<ol style="list-style-type: none"> 1. Press ENTER to access Main Menu. 2. Press 2 for Point Status. 3. From the list that displays, select the SLC module where the point you want to view is located. 4. The fourth line of the display shows the sensitivity status. "NORMAL" means the detector is in compliance with NFPA 72. "CAL MAINT" means the detector is in compliance with NFPA 72 but maintenance should be performed soon. "CAL TRBLE" means the detector is not in compliance with NFPA 72.
Set Time and Date	<ol style="list-style-type: none"> 1. Press ENTER to access Main Menu. 2. Press 4 to select Set Time & Date. Enter a code if prompted 3. Make changes in the fields on the screen as necessary. 4. When the time and date are correct, press ENTER.
Enable / Disable a Point	<ol style="list-style-type: none"> 1. Press ENTER to access Main Menu. 2. Press 2 to select Point Functions. 3. Press 1 for Disable / Enable Pt 4. Press 7 for Disable / Enable Pt. 5. Use the Up or Down button to move through the list. Then press ENTER to select the module where the point you want to disable/enable is located 6. Enter the point or circuit number that you want to disable/enable. 7. Press the right arrow key to toggle between NORMAL (enable) or DISABLE.
View Event History	<ol style="list-style-type: none"> 1. From the Program Menu. 2. Press 3 to select Event History. 3. Press the Up or Down button to view events in the history buffer.
For Service Call:	

Cut Along the Dotted Line



6820EVS Basic Operating Instructions

These instructions must be framed and displayed next to the 6820EVS panel in accordance with NFPA 72 fire code for Local Protected Fire Alarm Systems

FS= Fire System EVS = Emergency Voice System	
Operation	Task to Perform
Silence Alarms and Troubles	Press SILENCE then enter a code if prompted. Silence LED will light.
Reset Alarms	<ol style="list-style-type: none"> 1. Press RESET. 2. Press 1 to Reset Fire System. 3. Press 2 to Reset Emergency System. <p><i>Note: To reset EVS at an LOC, the user must gain EVS Control. (See Figure 1).</i></p>
View all active alarms, troubles, and supervisories signals	<p>The highest priority event will display first. Press the Down arrow to view location and type of alarm or trouble.</p> <div style="border: 1px solid black; padding: 5px; text-align: center; margin: 10px auto; width: fit-content;"> <pre> FIRE: ALARM SUPERVISORY TROUBLE CO: ALARM SUPERVISORY EMERGENCY: ALARM SUPERVISORY SYSTEM: TROUBLE </pre> </div>
View a Point's Status	<ol style="list-style-type: none"> 1. Press ENTER to access Main Menu. 2. Press 2 to select Point Functions. 3. Then press 2 to select Point Status. 4. Select the module the device is located on by using the Up or Down button. Then press ENTER. 5. Enter the point number.
Conduct a Fire Drill	<ol style="list-style-type: none"> 1. Press ENTER to access Main Menu. 2. Then Press 1 to select System Tests. 3. Press 1 to select Fire Drill. 4. Press ENTER to start the fire drill. 5. Press ENTER to end the fire drill.
Set Time and Date	<ol style="list-style-type: none"> 1. Press ENTER to access Main Menu. 2. Then press 4 to select Set Time & Date. Enter a code if prompted 3. Make changes in the fields on the screen as necessary. 4. Press ENTER if you wish to keep the changes. 5. Press ENTER to set the entered time and date.
Enable / Disable a Point	<ol style="list-style-type: none"> 1. Rotate the key or enter a code to access to access Main Menu. 2. Press 2 to select Point Functions. 3. Press 1 for Disable / Enable Pt 4. Press 7 for Disable / Enable Pt. 5. Use the Up or Down button to move through the list. Then press ENTER to select the module where the point you want to disable/enable is located 6. Enter the point or circuit number that you want to disable/enable. 7. Press the right arrow key to toggle between NORMAL (enable) or DISABLE.
To Gain / Request EVS Control	<ol style="list-style-type: none"> 1. Press the  Button and follow the on-screen Instructions. <p><i>Note: When EVS Control LED is blinking, another LOC has EVS Control. EVS Control LED is on steady when the LOC has EVS Control.</i></p>
For Service Call:	

Cut Along the Dotted Line

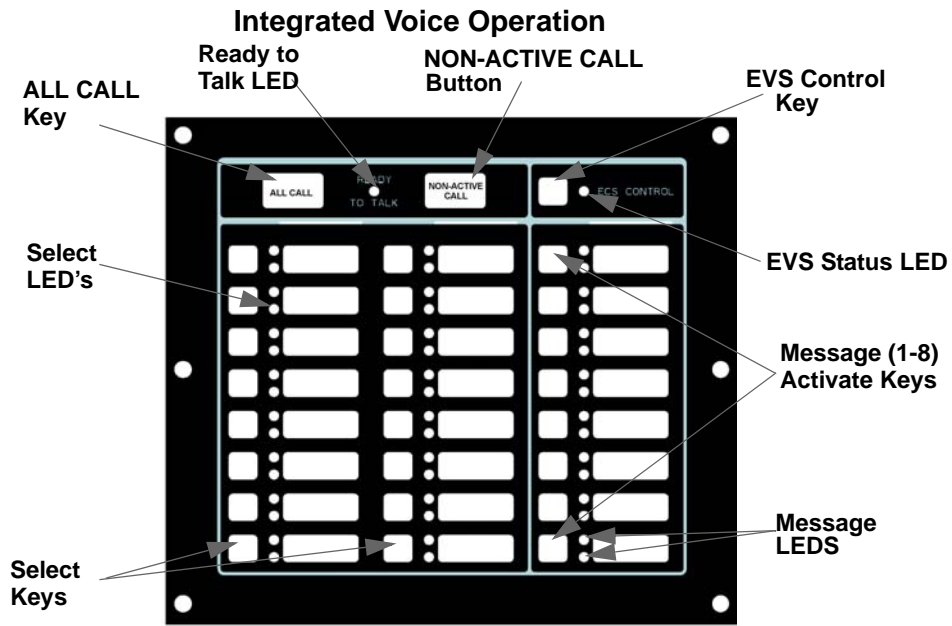

Table 1: LED Conditions

LED	Color	States	Meaning
Select Keys	Red	On	The corresponding area is active for the currently playing EVS message.
		Off	The corresponding area is not active.
	Green	On	The corresponding area is active for the microphone.
		Off	The corresponding area is not active for the microphone.
EVS Control LED	Green	On	LOC has EVS Control and the user is able to make changes to the EVS.
		Off	LOC does not have EVS Control.
		Blinking	Another LOC has EVS Control
EVS Message LED	Red	On	The corresponding EVS event was activated by an EVS device.
		Off	The corresponding EVS event is not active.
	Green	On	The corresponding EVS event is active and was generated from the LOC (or was activated from another LOC, but this LOC now has EVS Control).
		Off	The corresponding EVS event was not activated from this LOC or this LOC does not have EVS Control.

Table 2: EVS Control Request

Operation	Task
Gain EVS Control at an LOC	Press the EVS Control Key and enter a code if prompted. If EVS Control is available, the EVS Control LED will illuminate. If another LOC has EVS Control, the display will be similar to the one shown. Press 1 to request control. The LOC with EVS Control will then be able to allow or deny the request.
Gain EVS Control as EVS Super User at an LOC (only one EVS Super User is allowed EVS Control in the system at a time).	From the idle screen, enter an EVS Super User access code and then press the EVS Control Key. If EVS Control as Super User is available, the EVS Control LED will illuminate. If another LOC has Super User EVS Control, a request for Super User EVS Control will automatically be made to the LOC with control. The LOC with Super User EVS Control will then be able to allow or deny the request. (See Figure 1-2 for screen display example).
Select all output group for microphone override	Key the microphone, press the All Call Key, wait for the Ready-to-Talk LED to light, and then deliver your verbal message.
Select all non-activated output groups for microphone override	Key the microphone, press the Non-Active Call Key, wait for the Ready-to-Talk LED to light, and then deliver your verbal message.

How to Operate the Microphone:

1. Press the EVS Control button
2. Key the Microphone
3. Press the All Call button

How to Reset the EVS System

1. Press the Reset button
2. Select 2 to Reset emergency system

EVS-LOC Operating Instruction

For Live Message

1. Key the Microphone.
2. Press the All Call Key or select desired output area using select keys.
3. Deliver your verbal message.

For Pre-recorded Message

1. Select desired EVS Message Key 1-8.
 - If EVS Control LED is on steady, the LOC has EVS Control.
 - If EVS Control LED is Blinking, another LOC has EVS Control.

Cut Along the Dotted Line

Honeywell

Silent Knight
12 Clintonville Road
Northford, CT 06472-1610
203-484-7161
Fax: 203-484-7118

www.silentknight.com