

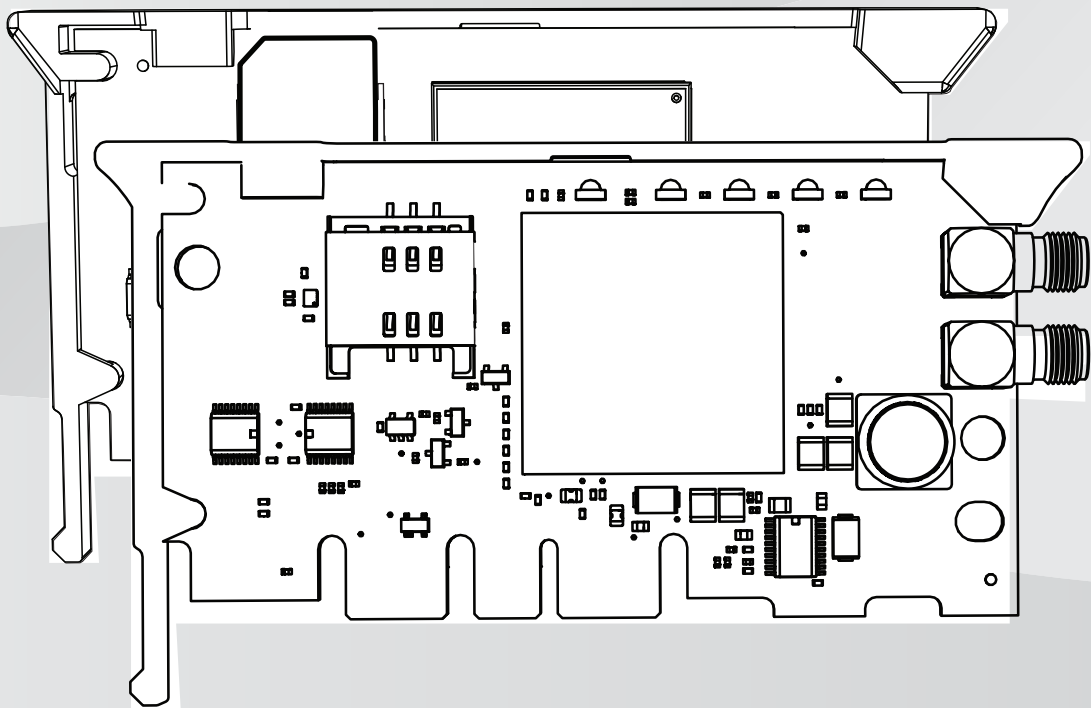

BOSCH

Conettix Cellular Communicators

B442/B443/B444/B444-A/B444-V



en

Installation Manual

Table of contents

1	Cellular module introduction	4
1.1	About documentation	4
1.2	Bosch Security Systems, Inc. product manufacturing dates	4
2	Component overview	5
3	Installation	8
3.1	Insert the SIM card	8
3.2	Install the antenna	8
3.3	Install the communicator	10
3.4	Remove the communicator	12
4	Diagnostic LED descriptions	13
5	Configuration	14
5.1	Activating the B444-A/B444-V	14
6	Specifications	15

1 Cellular module introduction

This document contains supplemental information needed to install the Conettix Plug-in Cellular communication modules.

This reference guide contains:

- Component location overview.
- Installation workflows.
- Diagnostic LED descriptions.
- Configuration.
- Specifications.

1.1 About documentation

Copyright

This document is the intellectual property of Bosch Security Systems, Inc. and is protected by copyright. All rights reserved.

Trademarks

All hardware and software product names used in this document are likely to be registered trademarks and must be treated accordingly.

1.2 Bosch Security Systems, Inc. product manufacturing dates

Use the serial number located on the product label and refer to the Bosch Security Systems, Inc. website at <http://www.boschsecurity.com/datecodes/>.

2 Component overview

Cellular plug-in communicators provide IP communications over supported cellular networks by directly connecting the communicator into a control panel or into an additional module such as the Conettix Plug-in Communicator Interface or the Conettix Universal Dual Path Communicator modules. All communicators come with a SIM card holder.

Communicators with SIM cards

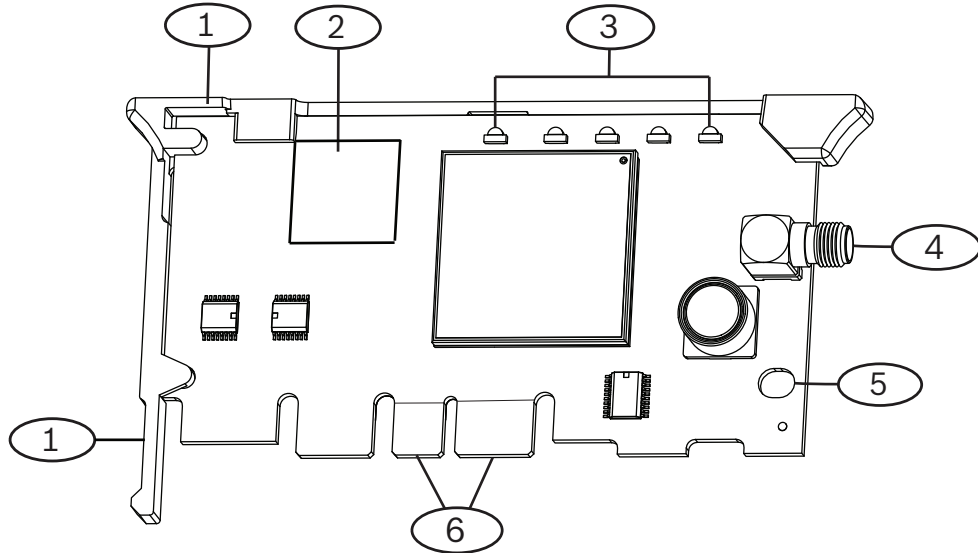

Callout - Description
1 - Module handle and support leg
2 - SIM card holder
3 - LEDs
4 - Threaded female SMA antenna connector
5 - Plug-in module retention clip opening
6 - PCM metal contacts

Communicators with SIM cards and dual antennas

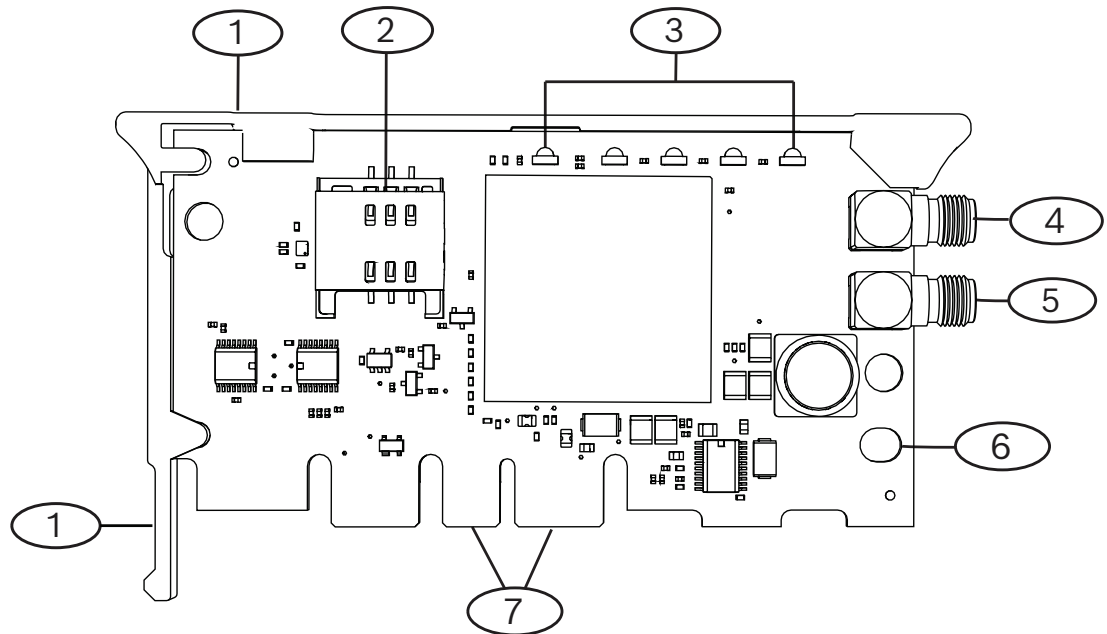

Figure 2.1: B444-A/B444-V

Callout - Description
1 - Module handle and support leg
2 - SIM card holder
3 - LEDs
4 - Threaded female SMA antenna connector (secondary)
5 - Threaded female SMA antenna connector (primary)
6 - Plug-in module retention clip opening
7 - PCM metal contacts



Notice!

Connections to both antenna connectors (secondary and primary) must be installed using the supplied antennas or an extended antenna (sold separately). Failure to do so might cause poor signal strength.

When using an external antenna such as the Bosch Multiband Antenna (B40-P, B40-MB25 or B40-MB50) connect the cable to the primary connector of the B444-A/V cellular module. You must also connect the supplied antenna to the secondary antenna connection. Failure to do so may result in poor service and dropped signals or connection.

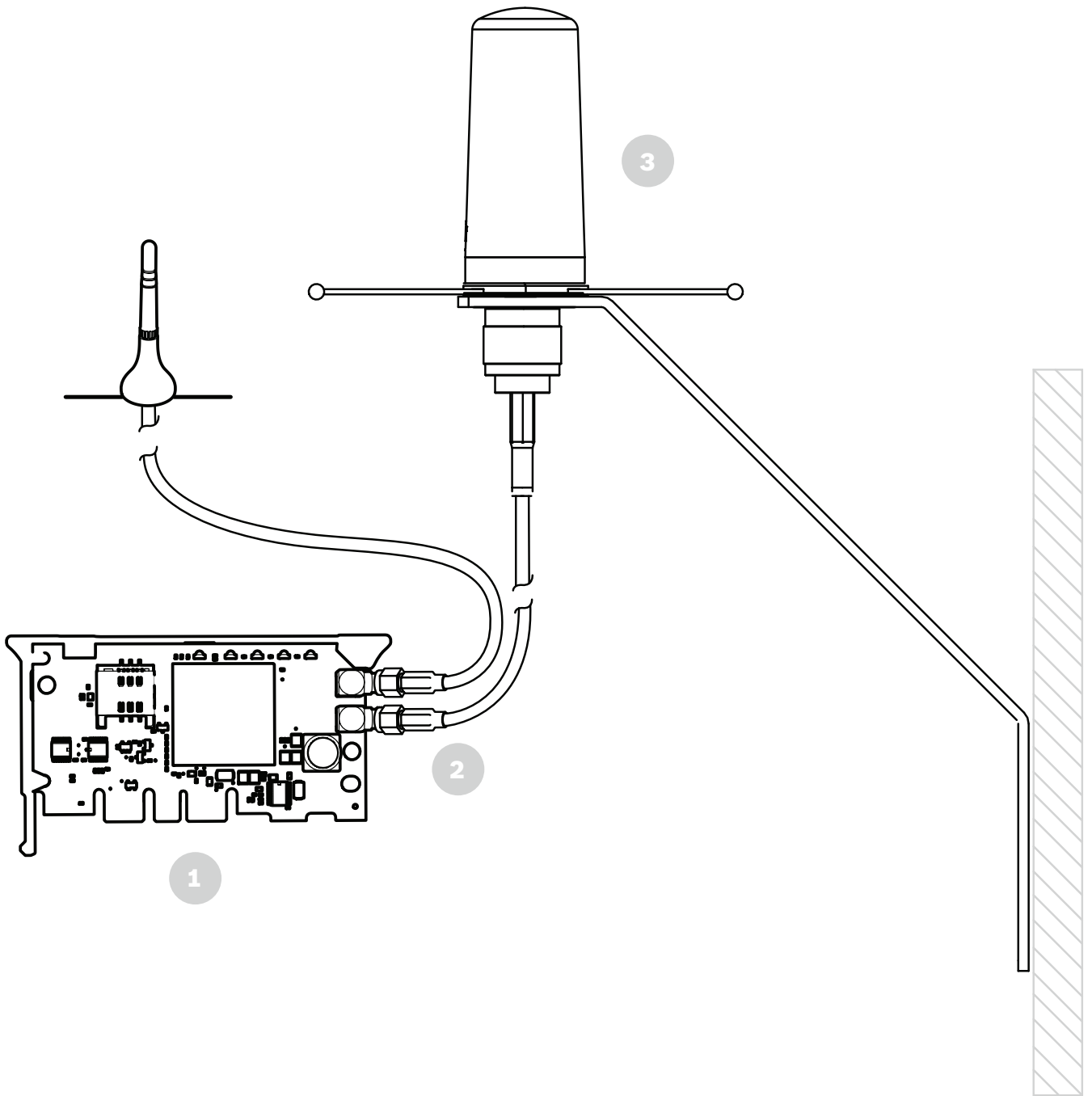

1	B444-V/B444-A cellular module
2	Primary antenna connection port
3	B40-P/MB25/MB50 external antenna

1. Connect antenna wire to the B40-P/MB25/MB50 antenna port (callout #3).
2. Connect other end of B40-P/MB25/MB50 antenna wire to primary antenna port on B444-V/B444-A cellular module (callout #2).

3 Installation

When installing the communicator into a supporting module or control panel, refer to the compatible documentation for more information.

**Caution!**

Remove all power (AC and battery) before making any connections. Failure to do so might result in personal injury and/or equipment damage.

3.1 Insert the SIM card

Follow these instructions for SIM card installation on B442 and B443.

1. Break away the SIM card from the die-cut.
2. Insert the SIM card into the SIM card holder by sliding it into the card holder.
3. Make sure the gold contact side of the SIM card is against the module.

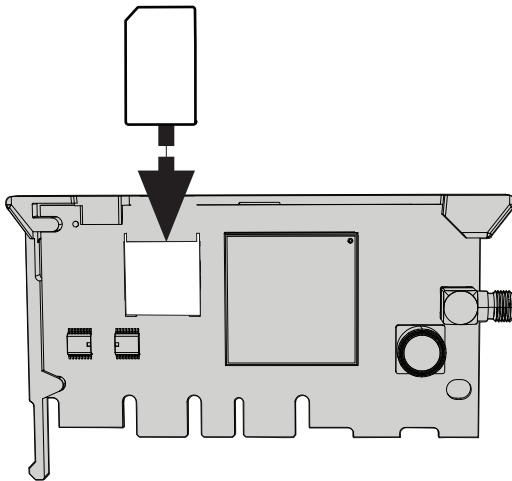

Figure 3.1: Inserting the SIM card

3.2 Install the antenna

**Notice!**

EN certification

On the B442 and B443, the length of the antenna cable may not exceed 30 m (98 ft) in order to comply with EN certification.

1. Put the magnetic antenna on top of the enclosure, or vertically on another metal surface.
2. Put the antenna cable through a knockout.
3. Connect the antenna cable to the module.
4. Make sure the antenna cable is inside the enclosure.

**Notice!**

Refer to the B444-A/B444-V Quick Installation Guide for detailed installation instructions.

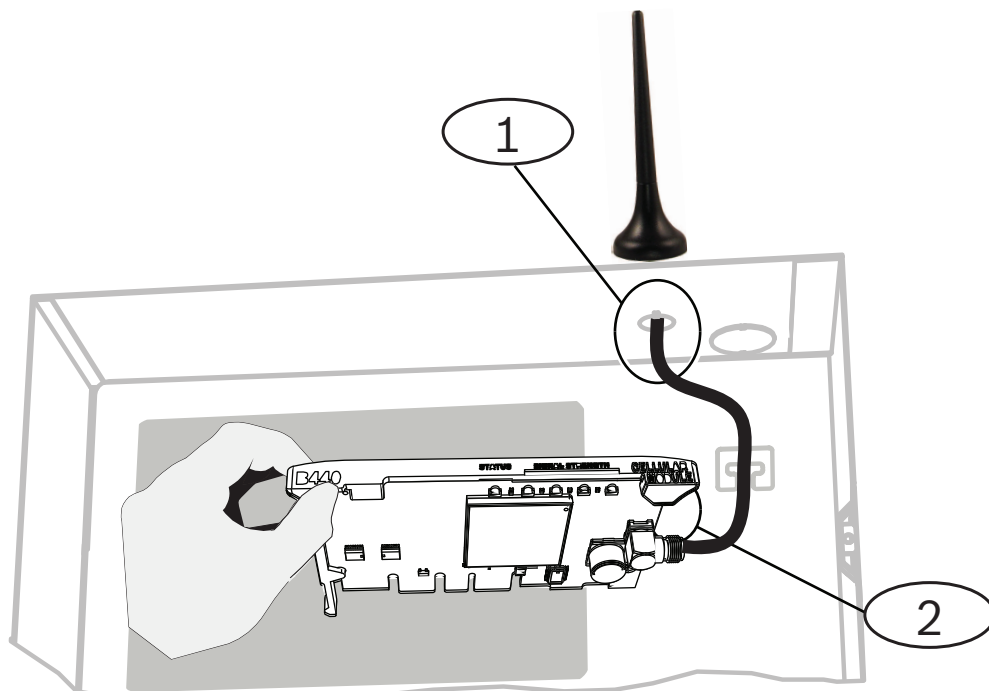

Figure 3.2: Installing the antenna

Callout - Description
1 - Antenna routed through any knockout
2 - Antenna cable connected to the module

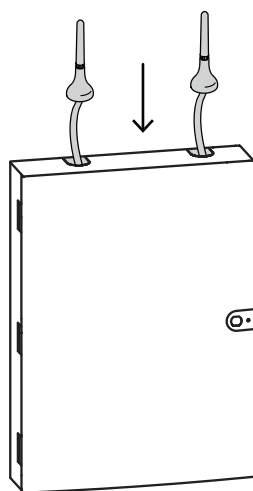

Figure 3.3: B444-A/B444-V antenna installation

**Notice!**

For proper spacing, the antennas should be placed at either corner of the enclosure.

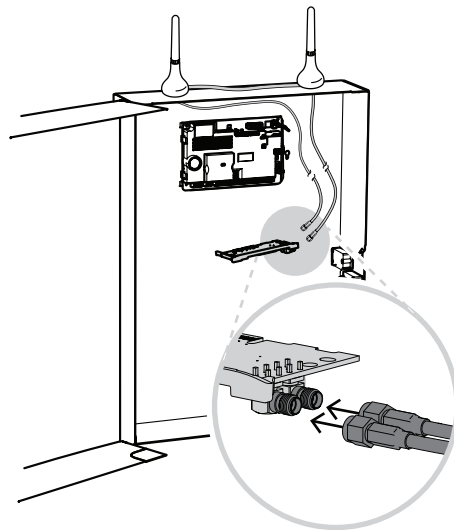

Figure 3.4: B444-A/B444-V cable connection

3.3

Install the communicator

Control panel/universal dual path communicator installation

1. Put the support leg into the support hole labeled X. Refer to *Figure 3.3*.
2. Align the PCB metal contacts with the on-board connector.
3. Push the module into place. The retention clip snaps closed and secures the module in place.

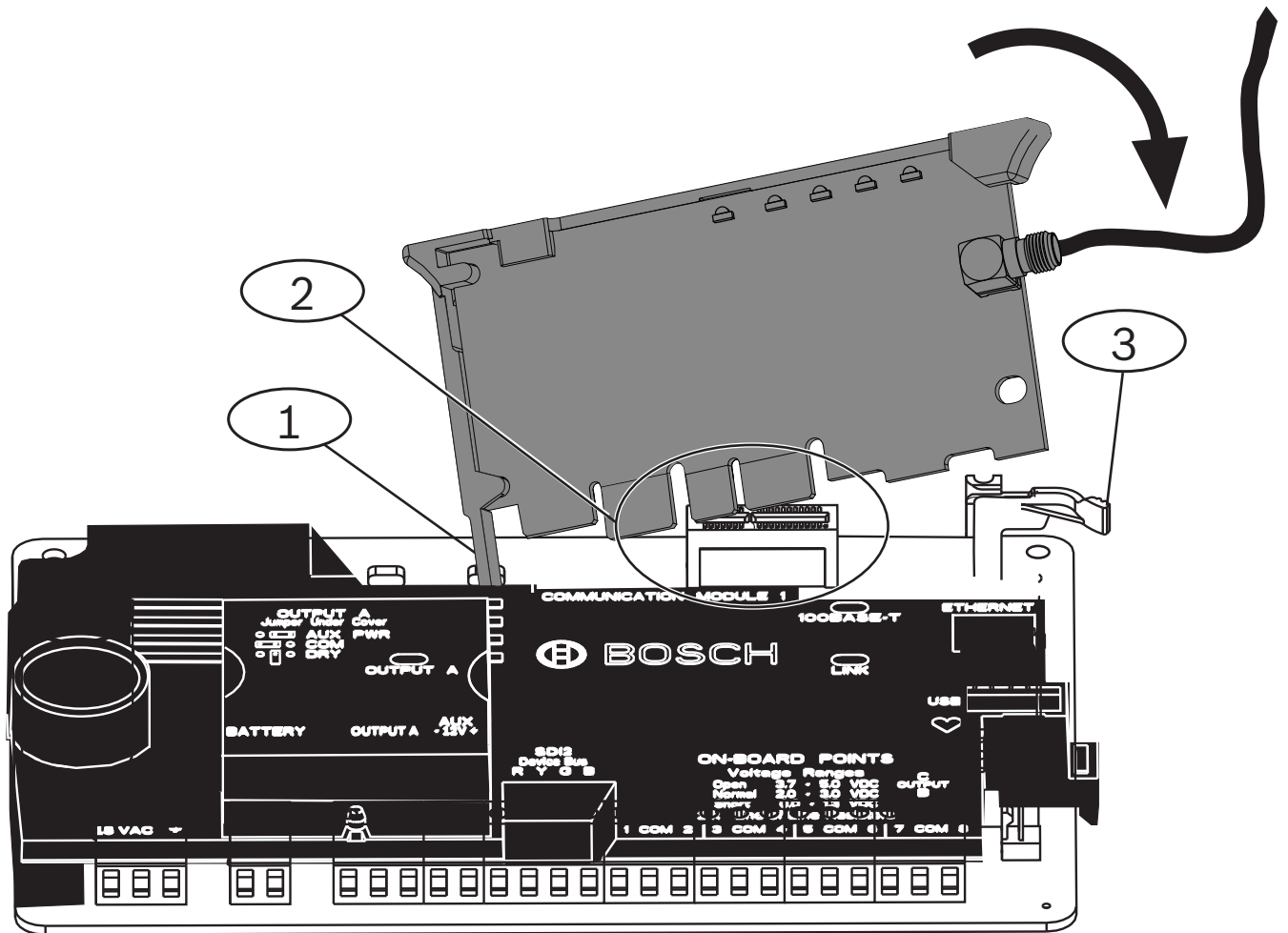

Figure 3.5: Communicator installation (B6512 control panel shown)

Callout - Description
1 - Support leg inserted into the compatible device support holes
2 - PCB metal contacts resting on the on-board connector
3 - Plug-in communicator retention clip

Plug-in communicator interface installation

1. Insert the communicator into the slot of the plug-in communicator interface.
2. Push in until you feel it "click" into place.

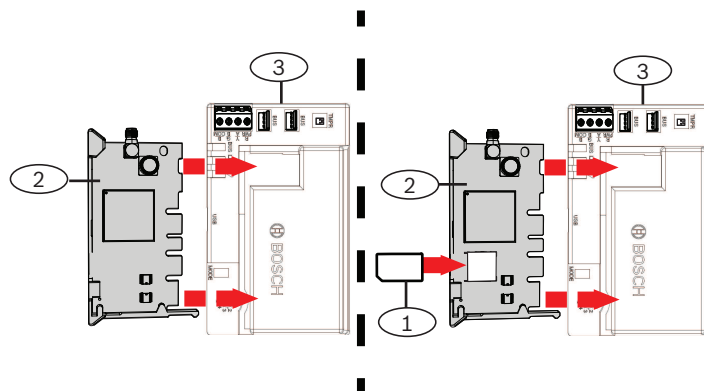

Figure 3.6: Communicator installation (B450 shown)

Callout - Description
1 - SIM card insertion (if applicable)
2 - Communicator
3 - Plug-in communicator interface

3.4 **Remove the communicator**





1. Hold the plug-in module retention clip open.
2. Hold the top corners of the module support handle with your other hand.
3. Pull the module out.

4 Diagnostic LED descriptions

At power up, all communicator LEDs activate for several seconds, indicating proper insertion. The Signal LEDs then turn off until the module registers on the cellular network. Registering a new module might take up to 2 min.

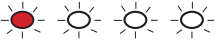

Check the LED display to ensure a good signal strength level, and adjust the antenna location as required. The signal strength LEDs momentarily turn off to indicate the module has measured and updated the signal strength status.

Signal strength

Flash pattern	Function
Red 	Indicates an unacceptable signal strength level.
Yellow 	Indicates a marginal signal strength level.
Green (1 light) 	Indicates a good signal strength level.
Green (2 lights) 	Indicates a very good signal strength level.
No LED	Indicates that the module has not acquired a tower yet.

Tab. 4.1: Signal strength LED descriptions

STATUS

Flash pattern	Function
Flashes once every 1 sec (blue) 	Normal State: Indicates normal operation.
On Steady (blue) 	Communication Error State: Indicates the communicator is unable to communicate on the cellular network.
Off 	LED Trouble State: Indicates communicator is not powered, or some other trouble condition prohibits the communicator from controlling the STATUS LED. (Check for proper installation.)

Tab. 4.2: STATUS LED descriptions

5 Configuration

Communicator programming is done through the compatible control panel, plug-in communicator interface, or universal dual path communicator. Refer to the documentation of these devices or remote programming software help for more information. For Bosch Cellular account status and management, use RPS or the online service portal (go to <http://www.conettix.com/plansandrecommendedsettings> and click on the Cellular Portal Login link). Configure network alarm communication routes and settings in the control panel. Cellular carrier specific settings such as Access Point Name and SIM card security can also be programmed through the control panel or Conettix Plug-in Communicator Interface.

5.1 Activating the B444-A/B444-V

The B444-A and B44-V communicator requires a valid Bosch Installer Services account and must be activated with a valid cellular plan for proper usage. If your device requires activation:

- contact Bosch Installer Services by submitting a support ticket via the Bosch Cellular Portal email at: installer.services@us.bosch.com, or
- call Bosch Installer Services (800-289-0096).

Please provide the IMEI and ICCID numbers found on the box or on the communicator for proper activation.

6 Specifications

Refer to the communicator graphical installation manuals for communicator specification information.



Bosch Security Systems B.V.

Torenallee 49

5617 BA Eindhoven

Netherlands

www.boschsecurity.com

© Bosch Security Systems B.V., 2020