



Liquid Crystal Display LCD-160 Manual

Document 51850
10/07/2016

Rev: **D2**

P/N 51850.D2

ECN 16-0219

Fire Alarm & Emergency Communication System Limitations

While a life safety system may lower insurance rates, it is not a substitute for life and property insurance!

An automatic fire alarm system—typically made up of smoke detectors, heat detectors, manual pull stations, audible warning devices, and a fire alarm control panel (FACP) with remote notification capability—can provide early warning of a developing fire. Such a system, however, does not assure protection against property damage or loss of life resulting from a fire.

An emergency communication system—typically made up of an automatic fire alarm system (as described above) and a life safety communication system that may include an autonomous control unit (ACU), local operating console (LOC), voice communication, and other various interoperable communication methods—can broadcast a mass notification message. Such a system, however, does not assure protection against property damage or loss of life resulting from a fire or life safety event.

The Manufacturer recommends that smoke and/or heat detectors be located throughout a protected premises following the recommendations of the current edition of the National Fire Protection Association Standard 72 (NFPA 72), manufacturer's recommendations, State and local codes, and the recommendations contained in the Guide for Proper Use of System Smoke Detectors, which is made available at no charge to all installing dealers. This document can be found at <http://www.systemsensor.com/appguides/>. A study by the Federal Emergency Management Agency (an agency of the United States government) indicated that smoke detectors may not go off in as many as 35% of all fires. While fire alarm systems are designed to provide early warning against fire, they do not guarantee warning or protection against fire. A fire alarm system may not provide timely or adequate warning, or simply may not function, for a variety of reasons:

Smoke detectors may not sense fire where smoke cannot reach the detectors such as in chimneys, in or behind walls, on roofs, or on the other side of closed doors. Smoke detectors also may not sense a fire on another level or floor of a building. A second-floor detector, for example, may not sense a first-floor or basement fire.

Particles of combustion or "smoke" from a developing fire may not reach the sensing chambers of smoke detectors because:

- Barriers such as closed or partially closed doors, walls, chimneys, even wet or humid areas may inhibit particle or smoke flow.
- Smoke particles may become "cold," stratify, and not reach the ceiling or upper walls where detectors are located.
- Smoke particles may be blown away from detectors by air outlets, such as air conditioning vents.
- Smoke particles may be drawn into air returns before reaching the detector.

The amount of "smoke" present may be insufficient to alarm smoke detectors. Smoke detectors are designed to alarm at various levels of smoke density. If such density levels are not created by a developing fire at the location of detectors, the detectors will not go into alarm.

Smoke detectors, even when working properly, have sensing limitations. Detectors that have photoelectronic sensing chambers tend to detect smoldering fires better than flaming fires, which have little visible smoke. Detectors that have ionizing-type sensing chambers tend to detect fast-flaming fires better than smoldering fires. Because fires develop in different ways and are often unpredictable in their growth, neither type of detector is necessarily best and a given type of detector may not provide adequate warning of a fire.

Smoke detectors cannot be expected to provide adequate warning of fires caused by arson, children playing with matches (especially in bedrooms), smoking in bed, and violent explosions

(caused by escaping gas, improper storage of flammable materials, etc.).

Heat detectors do not sense particles of combustion and alarm only when heat on their sensors increases at a predetermined rate or reaches a predetermined level. Rate-of-rise heat detectors may be subject to reduced sensitivity over time. For this reason, the rate-of-rise feature of each detector should be tested at least once per year by a qualified fire protection specialist. Heat detectors are designed to protect property, not life.

IMPORTANT! Smoke detectors must be installed in the same room as the control panel and in rooms used by the system for the connection of alarm transmission wiring, communications, signaling, and/or power. If detectors are not so located, a developing fire may damage the alarm system, compromising its ability to report a fire.

Audible warning devices such as bells, horns, strobes, speakers and displays may not alert people if these devices are located on the other side of closed or partly open doors or are located on another floor of a building. Any warning device may fail to alert people with a disability or those who have recently consumed drugs, alcohol, or medication. Please note that:

- An emergency communication system may take priority over a fire alarm system in the event of a life safety emergency.
- Voice messaging systems must be designed to meet intelligibility requirements as defined by NFPA, local codes, and Authorities Having Jurisdiction (AHJ).
- Language and instructional requirements must be clearly disseminated on any local displays.
- Strobes can, under certain circumstances, cause seizures in people with conditions such as epilepsy.
- Studies have shown that certain people, even when they hear a fire alarm signal, do not respond to or comprehend the meaning of the signal. Audible devices, such as horns and bells, can have different tonal patterns and frequencies. It is the property owner's responsibility to conduct fire drills and other training exercises to make people aware of fire alarm signals and instruct them on the proper reaction to alarm signals.
- In rare instances, the sounding of a warning device can cause temporary or permanent hearing loss.

A life safety system will not operate without any electrical power. If AC power fails, the system will operate from standby batteries only for a specified time and only if the batteries have been properly maintained and replaced regularly.

Equipment used in the system may not be technically compatible with the control panel. It is essential to use only equipment listed for service with your control panel.

Telephone lines needed to transmit alarm signals from a premises to a central monitoring station may be out of service or temporarily disabled. For added protection against telephone line failure, backup radio transmission systems are recommended.

The most common cause of life safety system malfunction is inadequate maintenance. To keep the entire life safety system in excellent working order, ongoing maintenance is required per the manufacturer's recommendations, and UL and NFPA standards. At a minimum, the requirements of NFPA 72 shall be followed. Environments with large amounts of dust, dirt, or high air velocity require more frequent maintenance. A maintenance agreement should be arranged through the local manufacturer's representative. Maintenance should be scheduled monthly or as required by National and/or local fire codes and should be performed by authorized professional life safety system installers only. Adequate written records of all inspections should be kept.

Limit-D-1-2013

Installation Precautions

Adherence to the following will aid in problem-free installation with long-term reliability:

WARNING - Several different sources of power can be connected to the fire alarm control panel. Disconnect all sources of power before servicing. Control unit and associated equipment may be damaged by removing and/or inserting cards, modules, or interconnecting cables while the unit is energized. Do not attempt to install, service, or operate this unit until manuals are read and understood.

CAUTION - System Re-acceptance Test after Software Changes: To ensure proper system operation, this product must be tested in accordance with NFPA 72 after any programming operation or change in site-specific software. Re-acceptance testing is required after any change, addition or deletion of system components, or after any modification, repair or adjustment to system hardware or wiring. All components, circuits, system operations, or software functions known to be affected by a change must be 100% tested. In addition, to ensure that other operations are not inadvertently affected, at least 10% of initiating devices that are not directly affected by the change, up to a maximum of 50 devices, must also be tested and proper system operation verified.

This system meets NFPA requirements for operation at 0-49° C/32-120° F and at a relative humidity 93% ± 2% RH (non-condensing) at 32°C ± 2°C (90°F ± 3°F). However, the useful life of the system's standby batteries and the electronic components may be adversely affected by extreme temperature ranges and humidity. Therefore, it is recommended that this system and its peripherals be installed in an environment with a normal room temperature of 15-27° C/60-80° F.

Verify that wire sizes are adequate for all initiating and indicating device loops. Most devices cannot tolerate more than a 10% I.R. drop from the specified device voltage.

Like all solid state electronic devices, this system may operate erratically or can be damaged when subjected to lightning induced transients. Although no system is completely immune from lightning transients and interference, proper grounding will reduce susceptibility. Overhead or outside aerial wiring is not recommended, due to an increased susceptibility to nearby lightning strikes. Consult with the Technical Services Department if any problems are anticipated or encountered.

Disconnect AC power and batteries prior to removing or inserting circuit boards. Failure to do so can damage circuits.

Remove all electronic assemblies prior to any drilling, filing, reaming, or punching of the enclosure. When possible, make all cable entries from the sides or rear. Before making modifications, verify that they will not interfere with battery, transformer, or printed circuit board location.

Do not tighten screw terminals more than 9 in-lbs. Overtightening may damage threads, resulting in reduced terminal contact pressure and difficulty with screw terminal removal.

This system contains static-sensitive components.

Always ground yourself with a proper wrist strap before handling any circuits so that static charges are removed from the body. Use static suppressive packaging to protect electronic assemblies removed from the unit.

Follow the instructions in the installation, operating, and programming manuals. These instructions must be followed to avoid damage to the control panel and associated equipment. FACP operation and reliability depend upon proper installation.

Precau-D1-9-2005

FCC Warning

WARNING: This equipment generates, uses, and can radiate radio frequency energy and if not installed and used in accordance with the instruction manual may cause interference to radio communications. It has been tested and found to comply with the limits for class A computing devices pursuant to Subpart B of Part 15 of FCC Rules, which is designed to provide reasonable protection against such interference when devices are operated in a commercial environment. Operation of this equipment in a residential area is likely to cause interference, in which case the user will be required to correct the interference at his or her own expense.

Canadian Requirements

This digital apparatus does not exceed the Class A limits for radiation noise emissions from digital apparatus set out in the Radio Interference Regulations of the Canadian Department of Communications.

Le présent appareil numérique n'émet pas de bruits radioélectriques dépassant les limites applicables aux appareils numériques de la classe A prescrites dans le Règlement sur le brouillage radioélectrique édicté par le ministère des Communications du Canada.

HARSH™, NIS™, NOTI•FIRE•NET™, and eVance™ are all trademarks; and Acclimate® Plus™, FlashScan®, FAAST Fire Alarm Aspiration Sensing Technology®, Intelligent FAAST®, NOTIFIER®, ONYX®, ONYXWorks®, SWIFT®, VeriFire®, and VIEW® are all registered trademarks of Honeywell International Inc. Microsoft® and Windows® are registered trademarks of the Microsoft Corporation. Chrome™ and Google™ are trademarks of Google Inc.

©2016 by Honeywell International Inc. All rights reserved. Unauthorized use of this document is strictly prohibited.

Software Downloads

In order to supply the latest features and functionality in fire alarm and life safety technology to our customers, we make frequent upgrades to the embedded software in our products. To ensure that you are installing and programming the latest features, we strongly recommend that you download the most current version of software for each product prior to commissioning any system. Contact Technical Support with any questions about software and the appropriate version for a specific application.

Documentation Feedback

Your feedback helps us keep our documentation up-to-date and accurate. If you have any comments or suggestions about our online Help or printed manuals, you can email us.

Please include the following information:

- Product name and version number (if applicable)
- Printed manual or online Help
- Topic Title (for online Help)
- Page number (for printed manual)
- Brief description of content you think should be improved or corrected
- Your suggestion for how to correct/improve documentation

Send email messages to:

FireSystems.TechPubs@honeywell.com

Please note this email address is for documentation feedback only. If you have any technical issues, please contact Technical Services.

Table of Contents

Section 1: About this Manual	7
1.1: Notes, Cautions, and Warnings.....	7
1.2: Typographic Conventions.....	7
Section 2: Installation Standards and Codes	8
2.1: Related Documentation.....	8
2.2: UL 9th Edition Compliance.....	8
Section 3: System Overview	9
3.1: Introduction to the LCD-160.....	9
3.2: Features and Specifications.....	9
3.2.1: Features.....	9
3.2.2: Specifications.....	9
3.3: Product Diagram.....	10
3.4: Installation Overview.....	11
Section 4: Hardware	12
4.1: Backboxes.....	12
4.2: Additional Hardware.....	13
Section 5: Mounting	15
5.1: Mount the Cabinet or Backbox.....	15
5.2: Mount the LCD-160.....	15
Section 6: Wiring	16
6.1: Overview.....	16
6.2: The RDP Bus.....	17
6.2.1: Wire Runs.....	17
6.2.2: RDP Bus Wiring Specifications.....	17
6.2.3: Shielding the RDP Bus.....	18
6.2.4: Connecting the RDP Bus.....	18
6.3: Earth Ground.....	19
6.4: Power Supply Connections.....	20
6.5: Connecting the Annunciator Key Switch.....	21
Section 7: The LCD-160 Interface	22
7.1: The Liquid Crystal Display.....	22
7.2: The Keypad.....	22
7.2.1: Soft Keys.....	22
7.2.2: Fixed Function Keys.....	23
7.2.3: Status LED Indicators.....	24
Section 8: Event Handling	25
8.1: About Events.....	25
8.1.1: System Normal Message.....	25
8.1.2: Event Reporting Format.....	25
8.2: The Display and Control Center (DCC).....	27
8.3: Event Handling.....	29
8.3.1: Acknowledging an Event.....	29
8.3.2: Types of Events.....	29
Section 9: Screen Displays	30
9.0.1: The Main Menu.....	30
9.0.2: The Graphic Screen.....	30
9.1: Programming Screens.....	31
9.1.1: Setting the Programming Switch.....	31
9.1.2: Panel Program Menu.....	32

9.1.3: LCD Display	32
9.1.4: Programming Confirmation Dialog	34
9.2: Operating Screens	34
9.2.1: Event Counts Display	34
9.2.2: More Information.....	36
9.2.3: Multiple Event List Display.....	37
9.3: Service Screens	39
9.3.1: Version Information.....	39
9.3.2: Power-up Screen	40
9.3.3: Download Screen.....	40
9.3.4: Download Application Screen.....	41
9.3.5: Download Bootloader Screen.....	41
9.3.6: Download Strings Screen	41
9.3.7: Application Corrupt Screen	42
Index	44

Section 1: About this Manual

1.1 Notes, Cautions, and Warnings

This manual contains notes, cautions, and warnings to alert the reader as follows:



NOTE: Supplemental information for a topic, such as tips and references.



NOTE: Information about procedures that could cause programming errors, runtime errors, or equipment damage.



WARNING:
INDICATES INFORMATION ABOUT PROCEDURES THAT COULD CAUSE IRREVERSIBLE EQUIPMENT DAMAGE, IRREVERSIBLE LOSS OF PROGRAMMING DATA OR PERSONAL INJURY.

1.2 Typographic Conventions

This manual uses the following conventions as listed below:

When you see	Specifies	Example
text in all caps and bold text	In body text, text as it appears in the LCD display or on the panel	MARCH TIME is a selection that appears in the LCD display; or Press the ENTER key
text in quotes	a reference to a section or a LCD menu screen	"Status Change" specifies the Status Change section or menu screen
bold text	In body text, a number or character that you enter	Press 1 ; means to press the number "1" on the keypad
italic text	a specific document	<i>NFS2-3030 Installation Manual</i>
a graphic of the key	In a graphic, a key as it appears on the control panel	Press  means to press the Escape key

Table 1.1 Typographic Conventions in this Manual

Section 2: Installation Standards and Codes

The LCD-160 is designed to comply with the following standards:

NFPA 72 National Fire Alarm Code

Underwriters Laboratories:

- UL 864 Standard for Control Units and Accessories for Fire Alarm Systems
- UL 1076 Standard for Proprietary Burglar Alarm Units and Systems
- UL 2017 Standard for General-Purpose Signaling Devices and Systems
- UL 2572 Standard for Mass Notification Systems

Underwriters Laboratories of Canada (ULC):

- ULC-S527-11: Standard of Control Units for Fire Alarm Systems

In addition, the installer should be familiar with the following standards:

- NEC Article 300 Wiring Methods
- NEC Article 760 Fire Protective Signaling Systems
- ULC-S524: Standard for the Installation of Fire Alarm Systems
- Applicable Local and State Building Codes
- Requirements of the Local Authority Having Jurisdiction
- The Canadian Electrical Code, Part 1

2.1 Related Documentation

To obtain a complete understanding of specific features of the LCD-160, or to become familiar with functions in general, make use of the documentation listed in Table 2.1.

Title	Document Number
NFS-3030 Installation Manual	51330
NFS-3030 Operation Manual	51344
NFS-3030 Programming Manual	51345
NFS2-3030 Installation Manual	52544
NFS2-3030 Operation Manual	52546
NFS2-3030 Programming Manual	52545
NCA-2 Instruction Manual	52482
VeriFire™ Tools Online Help	Included with VeriFire Tools
CAB-3/CAB-4 Series Installation Instructions	15330
Device Compatibility Document	15378
Mass Notification Systems Configuration, Programming and Operations Manual	LS10063-000NF-E

Table 2.1 Related Documentation

2.2 UL 9th Edition Compliance

This product has been certified to comply with the requirements in the Standard for Control Units and Accessories for Fire Alarm Systems, UL 864 9th Edition.

The following products have not received UL 864 9th Edition certification and may only be used in retrofit applications. Operation of the LCD-160 with products not tested for UL 864 9th Edition has not been evaluated and may not comply with NFPA 72 and/or the latest edition of UL 864. These applications will require the approval of the local Authority Having Jurisdiction (AHJ).

- NFS-3030 Fire Alarm Control Panel

Section 3: System Overview

3.1 Introduction to the LCD-160

The LCD-160 is a 240 x 128 pixel annunciator for NOTIFIER fire security control panels and network control annunciators. The LCD-160 can mimic the top half of the panel's display, or it can display custom messages or graphics. It has the capability to store character sets for multiple languages and supports Canadian requirements.

3.2 Features and Specifications

3.2.1 Features

- 160 character format LCD with contrast and backlight control.
- On-board input, output, and status indicators to support diagnostics.
- Software upgrades and foreign languages character sets via serial port from a panel or other device via the Remote Data Port (RDP) interface. Upgrades do not require the replacement of any programmable devices.
- Custom graphics.
- Rubberized keypad.
- Input for AKS-1 key switch.
- Non-volatile storage of local parameters/text and a single character set.
- Fits in two ACS Annunciator module locations.
- Display and Control Center (DCC) participation/indication.

3.2.2 Specifications

- 24 VDC input supply voltage via non-resettable power supply interface – **TB2**
- Data Communications Port: RDP interface (power-limited/Class 2) – **TB1**
 - There is a maximum of 4000 feet at 12 AWG to 18 AWG between the panel and the last device on the RDP bus (subject to your system's power restrictions).
 - Limit the total wire resistance to 100 ohms on the RDP bus, and 10 ohms on the RDP device power circuit. Unloaded resistance between RDP conductors must be greater than 1 Kohm. A remote power supply is required if total power wiring resistance exceeds 10 ohms.
- Current Draw
 - Standby Current, 0.300 A (backlight on), 0.075 A (backlight off)
 - Alarm Current, 0.325 A (backlight on, all pixels active, all LEDs active)

3.3 Product Diagram

Board Layout

The LCD-160 board layout is illustrated in Figure 3.1.

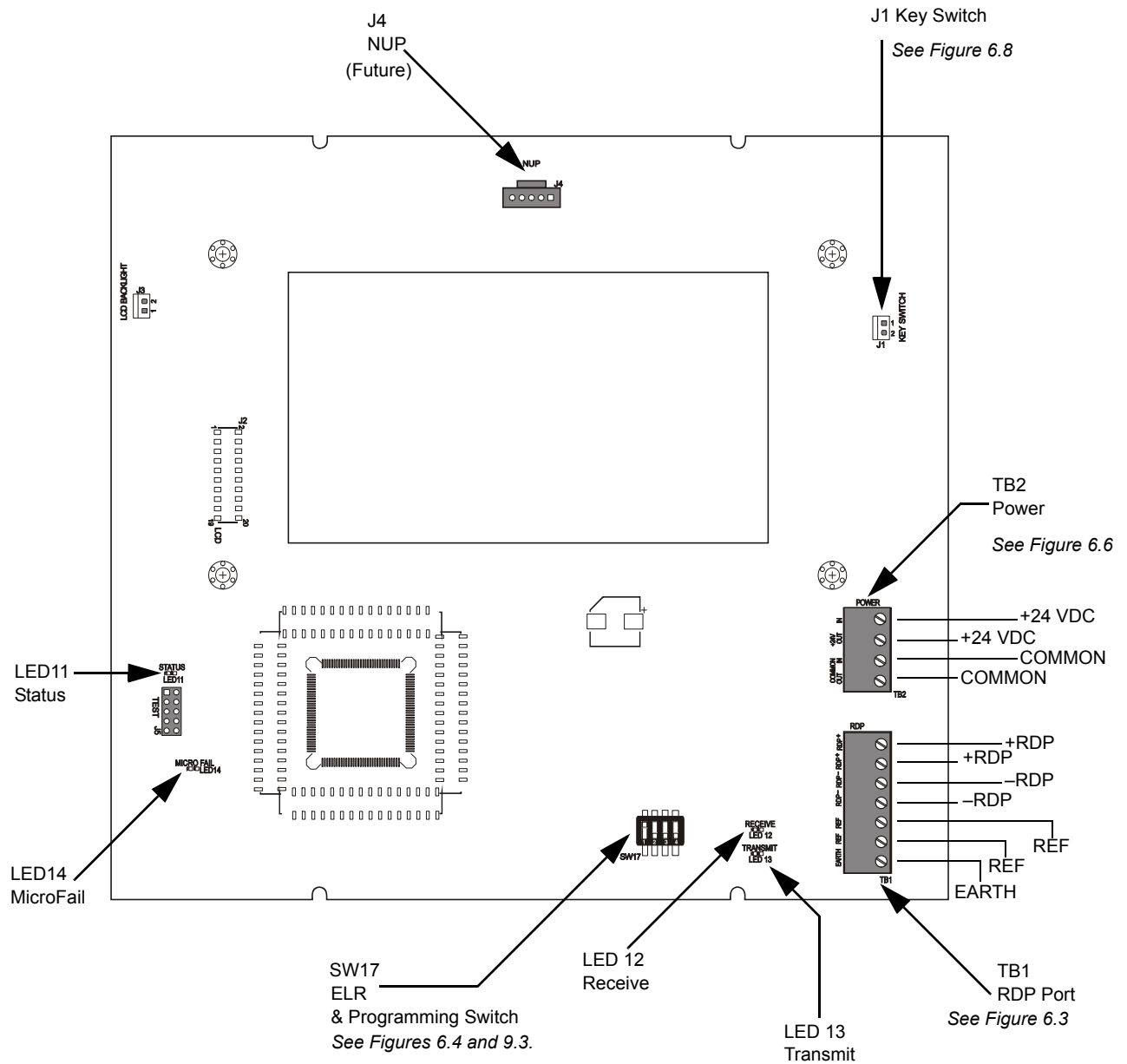

Figure 3.1 LCD-160 Board Layout

Diagnostic LED Indicators

LED indicators 11 through 14 aid in troubleshooting the LCD-160 and are visible to the installer only. Figure 3.1 shows the locations of the diagnostic LED indicators. Table 3.1 lists and describes the function of each of these diagnostic LED indicators. LED Indicators 1 through 10 indicate system status and are visible to the user. See “Status LED Indicators” on page 24 for information on LED indicators 1 – 10.

Reference	LED Name	Color	Description
LED11	STATUS	Green	Blinks when the LCD-160 is on. • Installer/Troubleshooting only.
LED12	RECEIVE	Green	Blinks when data is received from the panel. • Installer/Troubleshooting only.
LED13	TRANSMIT	Green	Blinks when data is transmitted to the panel. • Installer/Troubleshooting only.
LED14	MICROFAIL	Yellow	Illuminates if the microcontroller fails. • Installer/Troubleshooting only.

Table 3.1 Diagnostic LED Indicators

3.4 Installation Overview

1. Mount and ground the cabinet or backbox (Section 5.1).
2. Pull wiring into backbox (Figure 5.1).
3. Configure RDP bus ELR DIP switch (Figure 6.4).
4. Connect Earth Ground to a mounting screw on the backbox or cabinet (Section 6.3).
5. Mount the optional Annunciator Key Switch (Section 6.5).

If mounting into a CAB-4 series backbox: (Section 4)

1. Mount the LCD-160 to the dress panel (Figure 5.2).
2. Mount the dress panel to the backbox.
3. Make all electrical connections:
 - RDP bus & shielding if necessary. (Figures 6.2 & 6.3)
 - Power circuit (Figure 6.6)
4. Attach doors to backboxes (Section 5.2).
5. Power up system according to instructions in the control panel manual.
6. Configure the LCD-160 (Section 9.1).

If mounting into an ABS-2D/4D or ABF-2B/4B backbox: (Section 4)

1. Make all electrical connections:
 - RDP bus & shielding if necessary. (Figures 6.2 & 6.3)
 - Power circuit (Figure 6.6)
2. Mount the LCD-160 in the backbox.
3. Attach doors to backboxes (Section 5.2).
4. Power up system according to instructions in the control panel manual.
5. Configure the LCD-160 (Section 9.1).

Section 4: Hardware

This section is intended as a basic inventory of components that can be used with the LCD-160.

4.1 Backboxes



NOTE: For Canadian Applications, only the ABS-2DC, ABS-4DC, and the CAB-4 Series cabinets are approved for LCD-160 installation.

These backboxes provide a surface or semi-flush mount enclosure for remote mounting. Use with 1/2" conduit in the provided knockouts. See Table 4.1 for dimensions.

ABS-2D/ABS-2DR A surface or semi-flush enclosure for remote mounting. Mounts an LCD-160 directly to the enclosure's hinged dress plate. The "D" version is black and slightly deeper. The ABS-2D and ABS-2DR will not support the installation of the Annunciator Key Switch or the Annunciator Phone Jack for Firefighters' Telephone. A trim ring option is available for semi-flush mounting. Not for use in Canadian applications.

ABS-4D/ABS-4DR A surface or semi-flush enclosure for remote mounting. Mounts an LCD-160 and two annunciators directly to the enclosure's hinged dress plate. This backbox will not support the installation of the Annunciator Key Switch or the Annunciator Phone Jack for Firefighters' Telephone.

ABF-2B A flush enclosure for remote mounting. Mounts an LCD-160 directly to the enclosure's dress plate. Not for use in Canadian applications.

ABF-4B A flush enclosure for remote mounting. Mounts an LCD-160 and two annunciators directly to the enclosure's dress plate.

CAB-4 Series Cabinet A surface or semi-flush enclosure for mounting one to four rows of equipment plus batteries (up to two 25AH batteries). There are four different sizes available. The separately ordered doors can be mounted on the left or the right side of the cabinet; reversible hinges are provided so that this choice can be made in the field. Doors open a full 180 degrees and have locks. A trim ring option is available for semi-flush mounting.

External measurements for each cabinet size are provided below. Refer to *CAB-3/CAB-4 Series Cabinet Installation Document* (shipped with your cabinet) for specific mounting drawings and dimensions.

Part Number	Height	Width	Depth	Color	Optional Trim Ring
ABS-2D ABS-2DR	Box: 12.00" (30.48 cm.) Door: 12.00" (30.48 cm.)	Box: 12.00" (30.48 cm.) Door: 12.00" (30.48 cm.)	Box: 3.797" (9.644 cm) Door: 1.250" (3.175 cm.)	Red, Black	TR-ABS2D
ABS-4D ABS-4DR	Box: 11.97" (30.40 cm) Door: 11.97" (30.40 cm)	Box: 19.87" (50.47 cm) Door: 19.87" (50.47 cm)	Box: 3.5" (8.89 cm) Door: 1.25" (3.18 cm)	Red, Black	N/A
ABF-2B	Box: 9.938" (25.24 cm) Door: 11.0" (27.94 cm)	Box: 9.188" (20.80 cm) Door: 10.375" (26.35 cm)	Box: 3.750" (9.53 cm) Door: 0.75" (1.9 cm)	Black	N/A
ABF-4B	Box: 9.937" (25.240 cm)	Box: 17.750" (45.085 cm)	Box: 2.500" (6.350 cm)	Black	N/A
CAB-4 Series (without doors)					
A-Size (1 row)	20.125 in (51.12 cm)	24.125 in (61.28 cm)	5.218 in (13.25 cm)		TR-A4
B-Size (2 rows)	28.625 in (72.70 cm)	24.125 in (61.28 cm)	5.218 in (13.25 cm)		TR-B4

Table 4.1 Backbox Sizing Guide

Part Number	Height	Width	Depth	Color	Optional Trim Ring
C-Size (3 rows)	37.250 in (94.62 cm)	24.125 in (61.28 cm)	5.218 in (13.25 cm)		TR-C4
D-Size (4 row)	45.875 in (116.52 cm)	24.125 in (61.28 cm)	5.218 in (13.25 cm)		TR-D4

Table 4.1 Backbox Sizing Guide

4.2 Additional Hardware

DP-DISP Dress Panel Display provides for the cabinet mounting of an LCD-160. The DP-DISP hinge-mounts to the top bay of a CAB-4 series backbox and the LCD-160 mounts directly to threaded studs on the dress panel. An LCD-160 mounted on an DP-DISP fits in front of most CAB-4 series chassis as long as the top layer of the chassis is displayless or unoccupied.

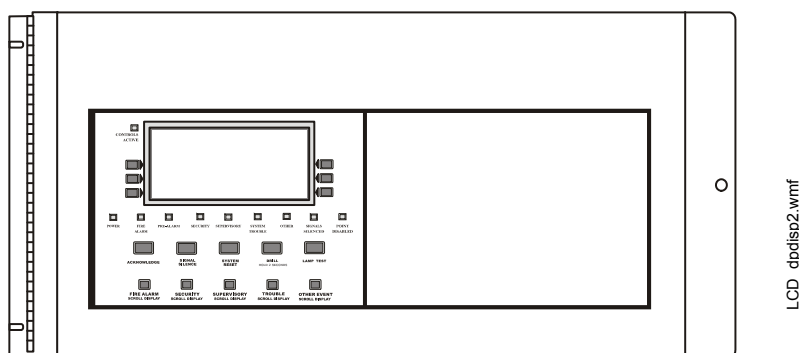

Figure 4.1 DP-DISP shown with an LCD-160

ADP-4B The Annunciator Dress Panel-4B provides for the cabinet mounting of an LCD-160. The black ADP-4B hinge-mounts on a CAB-4 series backbox and the LCD-160 mounts directly to threaded studs on the dress panel. An LCD-160 mounted on an ADP-4B fits in front of most CAB-4 series chassis as long as the top layer of the chassis is displayless or unoccupied.

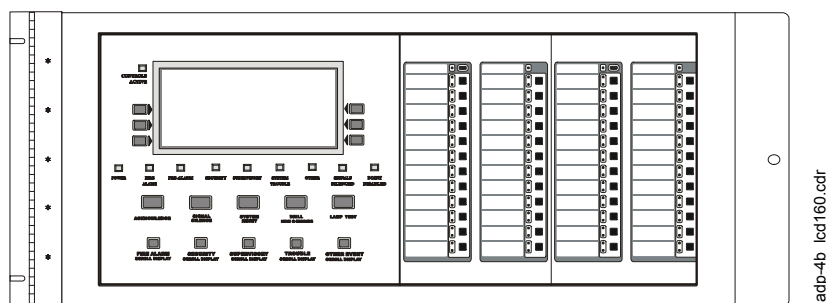
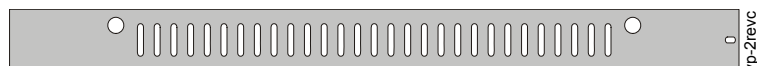

Figure 4.2 ADP-4B shown with LCD-160

VP-2B, VP-2 Use the VP-2B Vented Dress Panel when annunciators are to be installed in the top row of a Notifier cabinet with the ADP-4B. It covers the gap between the ADP-4B and the top of the cabinet. It secures to the cabinet with two screws.



AKS-1B, AKS-1 The Annunciator Key Switch provides access security for the control switches on the LCD-160. The key switch kit includes a key and hardware for mounting to the trim plate of a flush-mount type annunciator enclosure. An adhesive-backed Annunciator Label for use with the key switch/dress plate assembly is also included. The “B” version is black and displays the Notifier logo.

Section 5: Mounting

This section describes how to mount the LCD-160 into an enclosure.



WARNING:

USE A GROUNDING STRAP BEFORE HANDLING ANY CIRCUITS SO THAT STATIC CHARGES ARE REMOVED FROM THE BODY.

5.1 Mount the Cabinet or Backbox

Select an appropriate knockout on the enclosure for your wiring to run through and snap it out. Fasten the cabinet or backbox to the wall. Ground the enclosure to a solid metallic ground, such as a grounded cold water pipe. Pull all LCD-160 wiring into the enclosure as illustrated in Figure 5.1. Connect LCD-160 wiring to the removable terminal blocks as specified in “Connecting the RDP Bus” on page 18.

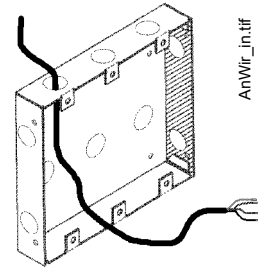

Figure 5.1 Pull Wiring into Enclosure

5.2 Mount the LCD-160

In an CAB-4 Series backbox:

1. Place the annunciator/dress-plate assembly into the backbox and secure with four screws.
2. Plug the two annunciator terminal blocks into the annunciator to complete communication and power circuit connections as described on “Connecting the RDP Bus” on page 18 and “Power Supply Connections” on page 20.
3. If using a semi-flush-mount backbox, attach the door. Align the door with the dress plate, and slide the door down onto the pins on the dress plate. When positioned correctly, the door will open and close freely.

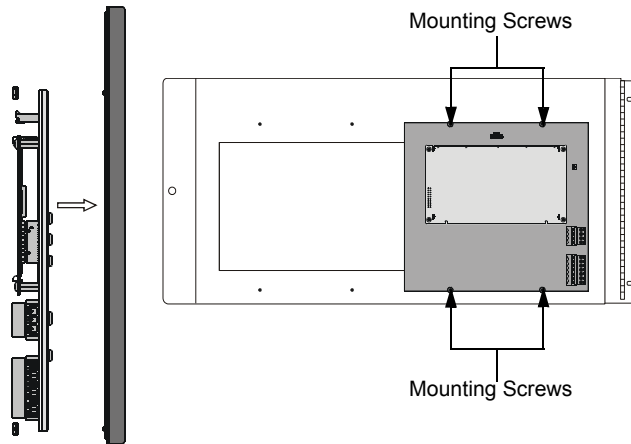

Figure 5.2 Mounting the LCD-160 to the Dress Panel

In an ABS-2D/4D or ABF-2B/4B backbox:

1. Plug the two annunciator terminal blocks into the annunciator to complete communication and power circuit connections as described in “Connecting the RDP Bus” on page 18 and “Power Supply Connections” on page 20.
2. Place the annunciator/dress-plate assembly into the backbox and secure with four screws.
3. If using a semi-flush-mount backbox, attach the door. Align the door with the dress plate, and slide the door down onto the pins on the dress plate. When positioned correctly, the door will open and close freely.

Section 6: Wiring

This section explains how to wire the LCD-160 for communication, power, and security.

6.1 Overview



WARNING:

REMOVE ALL POWER SOURCES TO EQUIPMENT WHILE CONNECTING ELECTRICAL COMPONENTS. LEAVE THE EXTERNAL, MAIN POWER BREAKER OFF UNTIL INSTALLATION OF THE ENTIRE SYSTEM IS COMPLETE.



WARNING:

SEVERAL SOURCES OF POWER CAN BE CONNECTED TO THE CONTROL PANEL. BEFORE SERVICING THE CONTROL PANEL, DISCONNECT ALL SOURCES OF INPUT POWER *INCLUDING THE BATTERY*. WHILE ENERGIZED, THE CONTROL PANEL AND ASSOCIATED EQUIPMENT CAN BE DAMAGED BY REMOVING AND/OR INSERTING CARDS, MODULES, OR INTERCONNECTING CABLES.

Complete all mounting procedures and check all wiring before applying power. The terminal block and pin connections are illustrated in Figure 3.1. Electrical connections are listed below and are detailed in the following paragraphs:

- **TB1** - Remote Data Port (RDP) interface connection.
- **TB2** - Power Supply connection
- **J1** - Key Switch connection
- **J4** - NUP Port (Future use)

Power-limited (Class 2) wiring must remain separated from non-power-limited wiring by at least 0.25 in. (6.4 mm), and must enter an enclosure through different knockouts. Install tie wraps and adhesive squares to secure the wiring.

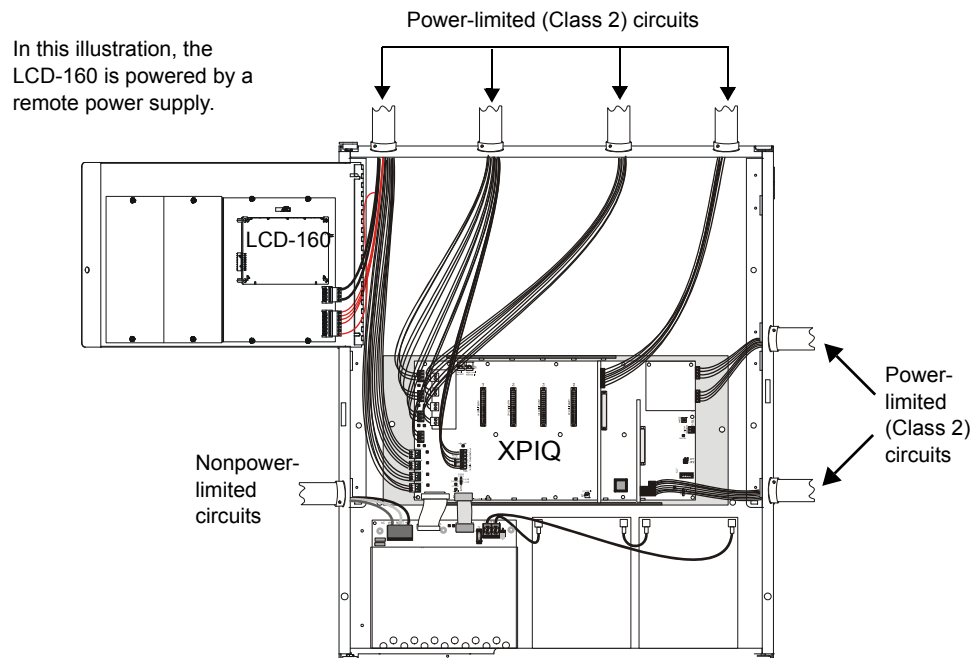

Figure 6.1 Typical Wiring for UL Power-limited Wiring Requirements (LCD-160 and XPIQ mounted in CAB-4 series backbox.)

6.2 The RDP Bus

6.2.1 Wire Runs

Communication between the control panel and any RDP device, such as the LCD-160, occurs over an RDP interface. This communication is supervised by the panel and the LCD-160.

The RDP bus can drive up to 32 RDP devices. The fire panel or network control annunciator must be at one end of the bus and an end-of-line resistor must be enabled on the last RDP device on the circuit. The actual number of RDP devices that can be powered in a particular system depends on the system's available power. Refer to the system's power documentation for more details.

Each LCD-160 on the bus requires a non-resettable 24 VDC power connection. This power circuit is inherently supervised and a loss of power registers as a communication failure at the control panel. The LCD-160 can be powered by a regulated remote power supply listed for fire-protective signaling use. If the 24VDC comes from a nonpower-limited source, the wiring must remain separate from the power-limited (Class 2) RDP bus.

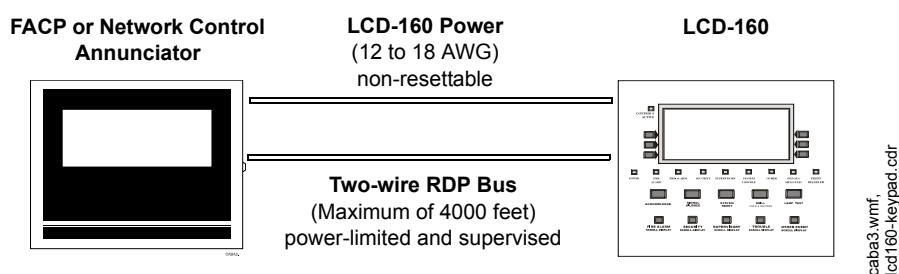

6.2.2 RDP Bus Wiring Specifications

Wire the RDP bus as shown in “Connecting the RDP Bus” on page 18. These requirements must be followed:

- There is a maximum of 4000 feet at 12 AWG to 18 AWG between the panel and the last device on the RDP bus (subject to your system's power restrictions).
- The wiring size must be a 12 AWG to 18 AWG twisted pair cable having a characteristic impedance of 120 ohms, +/- 20%.
- Limit the total wire resistance to 100 ohms on the RDP bus, and 10 ohms on the RDP device power circuit. Unloaded resistance between RDP conductors must be greater than 1 Kohm. A remote power supply is required if total power wiring resistance exceeds 10 ohms.
- Do not run cable adjacent to or in the same conduit as 120 volts AC service, “noisy” electrical circuits that are powering mechanical bells or horns, audio circuits above 25 volts RMS, motor control circuits, SCR power circuits, or nonpower-limited circuits.
- If RDP devices are to be mounted in separate cabinets or powered by a remote power supplies, see , “” on page 21.



WARNING:
TURN OFF ALL POWER WHEN CONNECTING THE LCD-160.

6.2.3 Shielding the RDP Bus

All enclosures, including the panel backbox, must be connected to earth ground! Never use the shield for grounding purposes. If shielded, terminate the RDP shield at one end only.

- When the RDP shield is in conduit: Connect it to a system reference (system common). The shield can enter the cabinet, but it must be insulated from the cabinet (no electrical contact). Between RDP devices, wire-nut multiple shields together (These shields can be inside of the respective enclosure, but can not contact the enclosure).
- When the RDP shield is not in conduit: Terminate the shield at the outside of the panel backbox (ground). Do not allow the shield to enter or even touch a cabinet that houses any remote RDP device. Between RDP devices, wire-nut multiple shields together outside of the respective enclosures (see Figure 6.2).

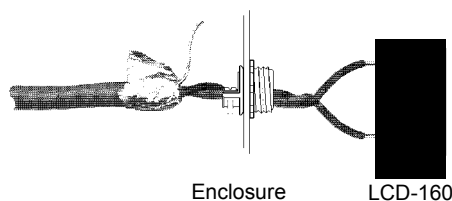

Figure 6.2 Terminating the Shield (Not in Conduit)

6.2.4 Connecting the RDP Bus

Figure 6.3 provides RDP circuit diagrams for the LCD-160.

See “RDP Bus Wiring Specifications” on page 17 for circuit requirements.

End-of-Line Resistor for RDP Devices

If the LCD-160 is the last device on the RDP bus, the end-of-line resistor on SW17 must be enabled.

SW17 is located on the bottom edge of the LCD-160 board. Switch 2 on the dip switch SW17 sets the end-of-line resistor for the RDP bus. To enable, use a small screwdriver to slide the switch towards the display screen. To disable, slide the switch away from the display screen. See Figure 6.4.

Remember to disable the end-of-line resistor for all preceding devices on the RDP bus. Turn off all power when connecting the LCD-160 to avoid damaging the equipment.

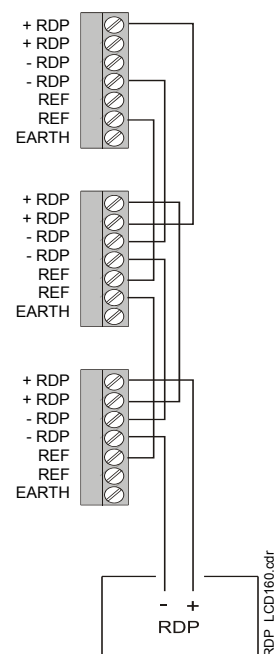

See Figure 6.4 to set on-board ELR for the LCD-160.

Note: Reference connections are only necessary when LCD-160s are powered by multiple power supplies.

Figure 6.3 Connecting the RDP Bus



NOTE: Switches 3 and 4 **MUST** remain disabled.

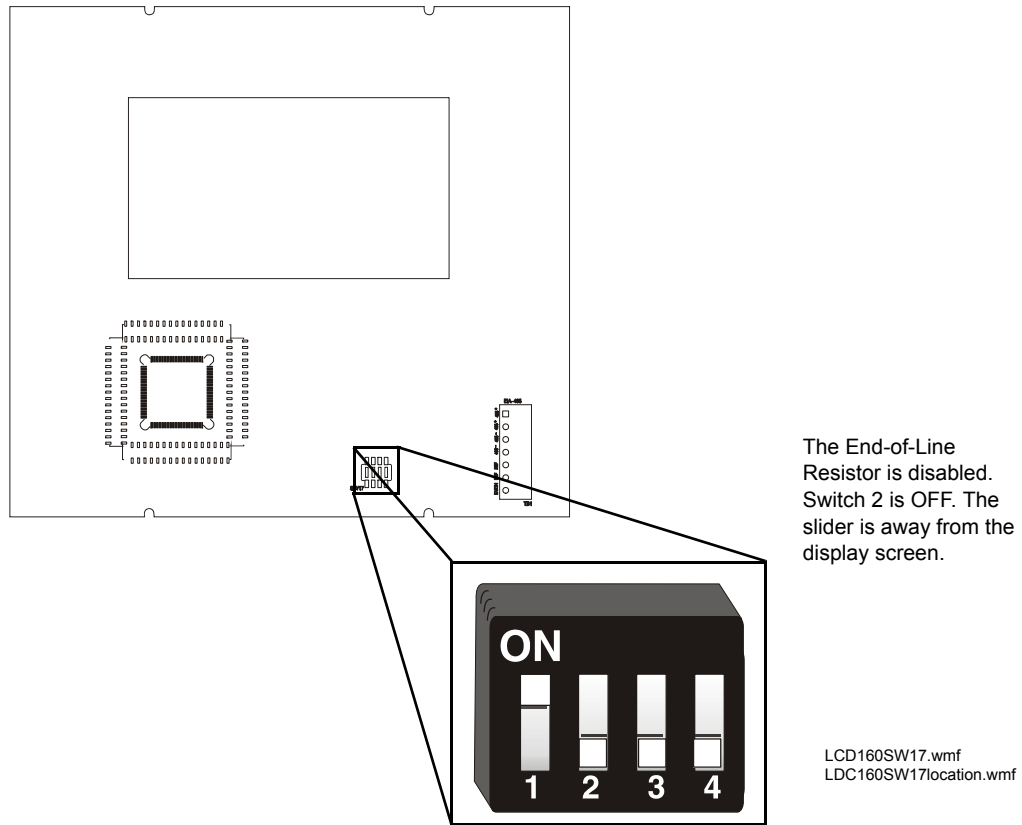

Figure 6.4 SW17 (ELR Disabled)

6.3 Earth Ground

During mounting (see Section 5.1), the backbox or cabinet should have been connected to a solid earth ground such as a cold water pipe. Connect the LCD-160's Earth Ground, located on the RDP interface, to a mounting screw on the backbox or cabinet. (See Figures 6.3 and 6.5.)

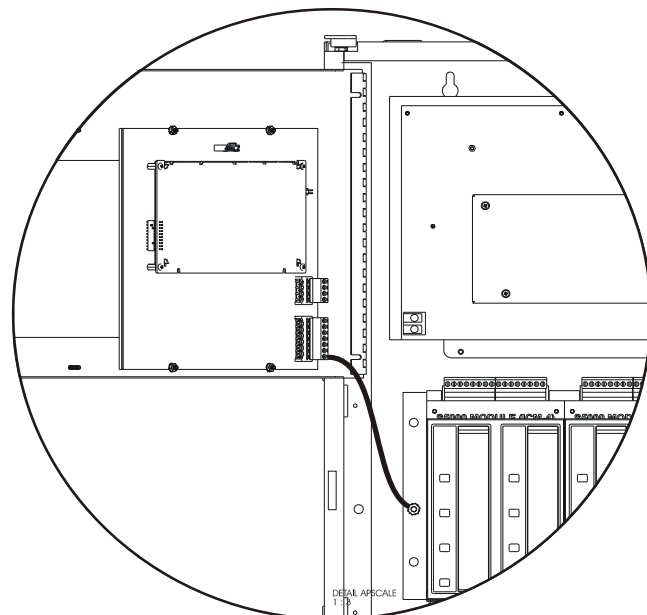
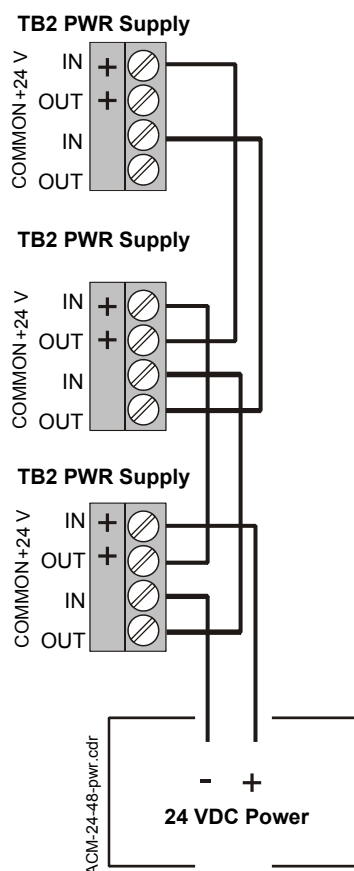

Figure 6.5 Grounding the LCD-160

6.4 Power Supply Connections



Note: On the LCD-160, earth ground is located on TB1 with the RDP interface.

Figure 6.6 Power Circuit for the LCD-160



NOTE: All power must be turned off when connecting the 24 VDC power to the LCD-160. Reapply power according to the instructions in your control panel manual.

The LCD-160's 24 VDC power source must be regulated, filtered, non-resettable, and listed for fire-protective signaling use. Sources include main power supplies, auxiliary power supplies, and panels with integrated power supplies. If RDP devices are to be powered by separate power supplies, a common reference connection must be established, see Figure on page 21. To maintain proper supervision, only one supply can have ground fault detection enabled.

The power run to the LCD-160 need not contain a Power Supervision Relay because loss of power is inherently supervised through communication loss (loss of RDP communication is registered at the control panel during loss of power to the LCD-160).

For details about connections to particular control panels, see the appropriate control panel manual.

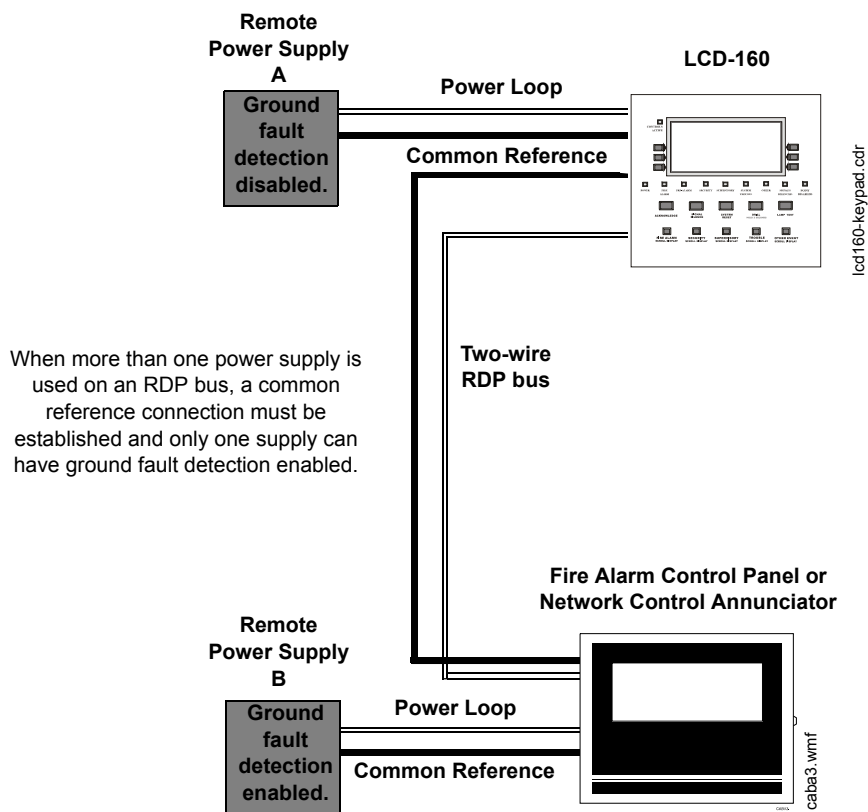

Figure 6.7 Using Multiple Power Supplies With the RDP Bus

6.5 Connecting the Annunciator Key Switch

Mount the key switch to the dress plate.

Plug the switch leads from the Annunciator Key Switch into the key switch connector.

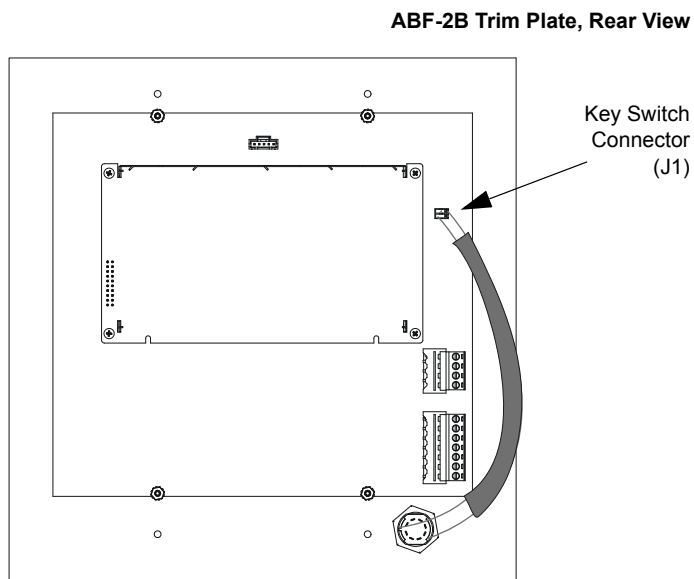

Figure 6.8 Connecting Annunciator Key Switch

Section 7: The LCD-160 Interface

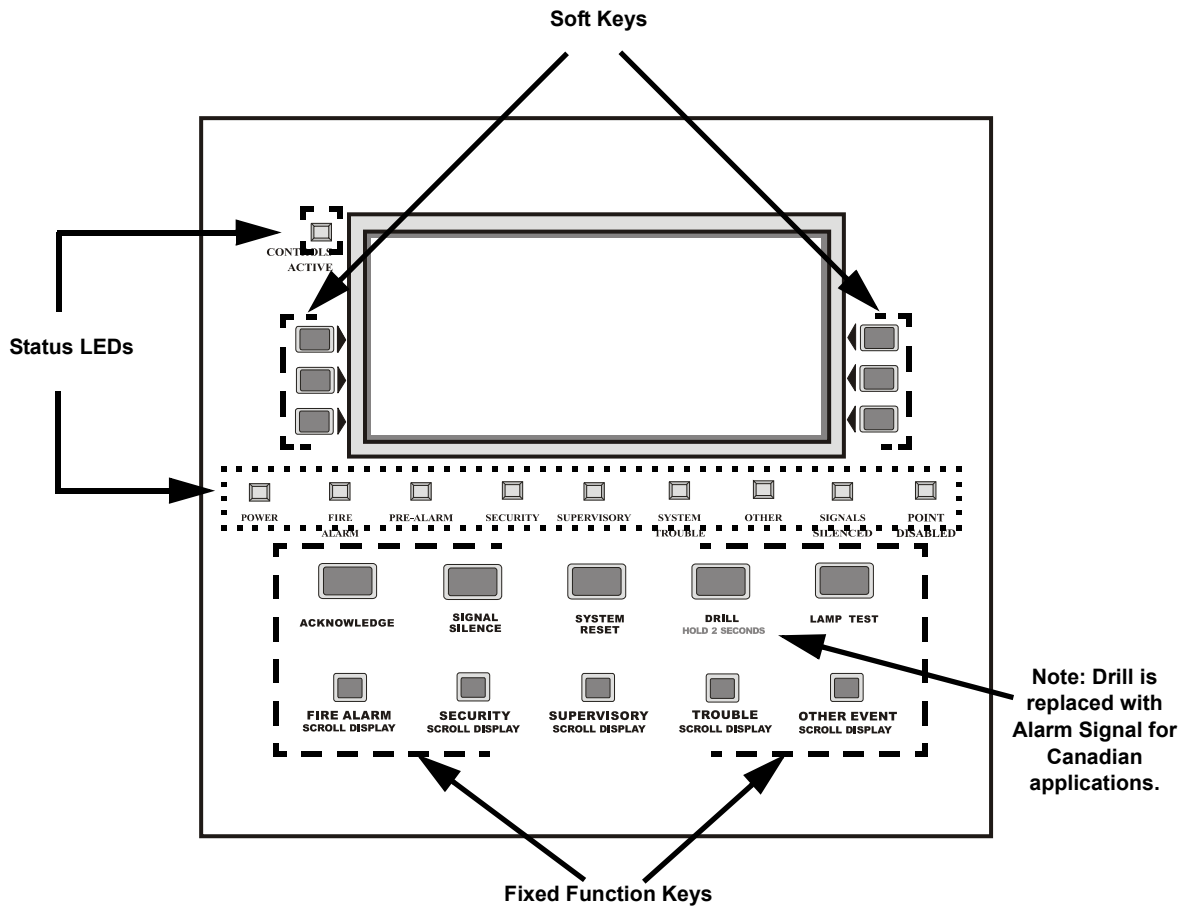

Figure 7.1 The LCD-160 Keypad

7.1 The Liquid Crystal Display

The display is 40 characters wide by 16 lines. It displays all programming screens, as well as other information.

Enter or change fields and issue commands on the display by using both the fixed function and soft keys on the keypad.

7.2 The Keypad

The keypad consists of two types of keys: soft keys and fixed function keys.

With the exception of the lamp test key, all keys are disabled when the Annunciator Key Switch is locked.

7.2.1 Soft Keys

The six keys to the right and left of the display function to select commands that appear on the display. Each screen has different information, and each key changes function to suit the screen. Beneath each screen in this manual is a description of the function of each soft key.

7.2.2 Fixed Function Keys

The ten keys labeled on the front of the LCD-160 are fixed function keys. If there is an active command center and DCC is enabled at the panel, Acknowledge, Signal Silence, System Reset, and Drill require permission before they can be processed. (See “The Display and Control Center (DCC)” on page 27.)

ACKNOWLEDGE - Press this key to send an acknowledge command to the panel.

The exact action to take on an acknowledge message is controlled by the panel.

Refer to the appropriate panel manual for further information about this function.

This key will not function if the key switch is locked or Local Control is disabled. See page 29 for more information about acknowledging events.



NOTE: If the LCD-160 loses communication with the host panel before all events are acknowledged, pressing an ACKNOWLEDGE key will only silence the LCD-160. It will not acknowledge any events.

SIGNAL SILENCE - Press this key to send a silence command to the panel. The exact action to take on a silence command is controlled by the panel. A “Signals Silenced” screen verifies the command on all networked displays. This key will not function if the key switch is locked or if Local Control is disabled.

Refer to the appropriate panel manual for further information about this function.

SYSTEM RESET - Press this key to send a system reset command to the panel. The exact action to take on a reset command is controlled by the panel. A “Reset Completed” screen verifies the command on all networked displays. This key will not function if the key switch is locked or Local Control is disabled. If the associated fire panel has both MNS and Fire alarm conditions present at the same, a second system reset is needed to fully reset the panel once the conditions have been cleared.

Refer to the appropriate panel manual for further information about this function.

DRILL(ALARM SIGNAL for Canadian applications) HOLD 2 SEC. - Press this key, holding it down for 2 seconds, to activate all silenceable fire output circuits. This key will not function if the key switch is locked or Local Control is disabled.

Refer to the appropriate panel manual for further information about this function.

LAMP TEST - Press this key to test the LED indicators and the piezo. If it is not disabled in programming, the backlight will go on and all pixels in the display will light during a lamp test. Pressing the key longer than 3 seconds will display firmware version numbers on the display screen.

FIRE ALARM SCROLL/DISPLAY
SECURITY SCROLL/DISPLAY
SUPERVISORY SCROLL/DISPLAY
TROUBLE SCROLL/DISPLAY
OTHER EVENT SCROLL/DISPLAY

Press any of these keys to display a list of associated events. Scroll to the next event on the list by pressing the same key again. The **OTHER EVENT SCROLL/DISPLAY** key scrolls between prealarm and disabled events.

7.2.3 Status LED Indicators

There are nine labeled LEDs aligned along the bottom of the display, and one LED at the upper left corner of the display. They light to annunciate certain conditions, as described in Table 7.1 below.

LED INDICATOR	COLOR	FUNCTION
Power	Green	Illuminates when AC power is within normal operating limits.
Fire Alarm	Red	Illuminates when at least one fire alarm event exists. It will flash if any of these events are unacknowledged.
Pre-Alarm	Red	Illuminates when at least one pre-alarm event exists. It will flash if any of these events are unacknowledged.
Security	Blue	Illuminates when at least one security event exists. It will flash if any of these events are unacknowledged.
Supervisory	Yellow	Illuminates when at least one supervisory event exists. It will flash if any of these events are unacknowledged.
System Trouble	Yellow	Illuminates when at least one trouble event exists. It will flash if any of these events are unacknowledged.
Other Event	Yellow	Illuminates for any category of event not listed above, including MNS alarms, Process Monitor, CO Alarm/Pre-alarm, Hazard and Weather Alerts. It will flash if any of these events are unacknowledged.
Signals Silenced	Yellow	Illuminates if Notification Appliances have been silenced. It flashes if some but not all of the NACs have been silenced.
Point Disabled	Yellow	Illuminates when at least one device has been disabled. It will flash until all disabled points have been acknowledged.
Controls Active	Green	Illuminates when the LCD-160 assumes control of the node as a primary display. See <i>"The Display and Control Center (DCC)"</i> on page 27.

Table 7.1 LED Indicators

Section 8: Event Handling

8.1 About Events

An event is a change in the status of a device, a transfer of information between a device and the LCD-160, or a transfer of information between two devices. Some events are considered background and housekeeping events and are not seen by the user. Events that are of primary concern to the operator are those identified as “off-normal events.” An off-normal event is an event which indicates activity or change in condition that requires the attention and/or response of an operator. Examples of possible off-normal events are:

- Activation or change in condition of a monitoring device (Smoke Alarms, Fire Alarms, etc.).
- System troubles, such as network problems, device supervision problems, etc.

8.1.1 System Normal Message

The System Normal message appears at the top of the display when no off-normal events exist. It consists of two lines, each 40 characters long. Line one is a custom message. Line two is a standard message showing the System Normal status.

Line five indicates the current time and date.

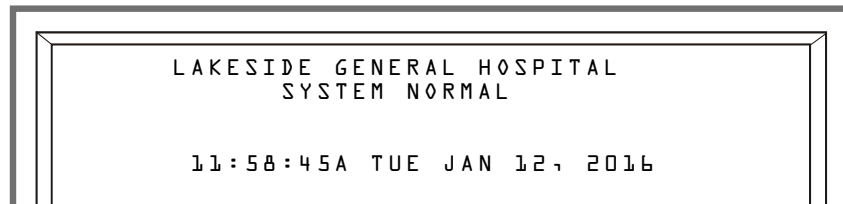

8.1.2 Event Reporting Format

When there is an off-normal event, the System Normal message will be replaced by a message in the Event Reporting format. There are two basic types of message formats: point event formats, which are generated from changes in the state of SLC and panel devices, and system event formats, which are generated from system errors and troubles.

Point Events Format

When a change of state occurs to an SLC or panel point device, a message, generated by the control panel, displays at the top of the LCD-160's screen, while soft keys display available functions that may be used to handle the event. The top four lines contain the event and point information. Event counts display in the next three lines, and the current time and soft key information appear after the event counts.

The format of the first line will vary slightly as follows, depending on the type of event.

Event	Line 1	→	FIRE ALARM		
Format	Displays the type of		ELEVATOR LOBBY	EAST WING	
(not trouble	event, and whether		FIFTH FLOOR	Z239 SMOKE(PHOTO)	
or pre-	it has been		11:58:45A TUE JAN 12, 2016	N112L03D002	
alarm)	acknowledged or				
	cleared.				
Event	Line 1	→	TROUBLE	DETECTOR FAILED TEST	
Format	Displays TROUBLE,		ELEVATOR LOBBY	EAST WING	
(trouble)	the type of trouble,		FIFTH FLOOR	Z239 SMOKE(PHOTO)	
	and whether it has		11:58:45A TUE JAN 12, 2016	N112L03D002	
	been acknowledged				
	or cleared.				
Event	Line 1	→	PREALARM 120% OF FIRE	SENSITIVITY LEVEL 5	
Format	Displays		ELEVATOR LOBBY	EAST WING	
(pre-alarm)	PREALARM, the		FIFTH FLOOR	Z239 SMOKE(PHOTO)	
	sensitivity reading		11:58:45A TUE JAN 12, 2016	N112L03D002	
	and whether it has				
	been acknowledged				
	or cleared.				

The second, third and fourth lines always contain the same device information, as follows:

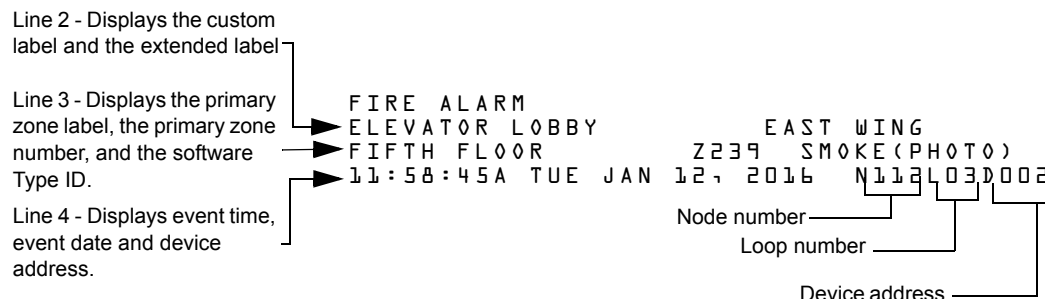

The point event example screen below shows a trouble condition that has been generated by the detector on loop 3, address 2.

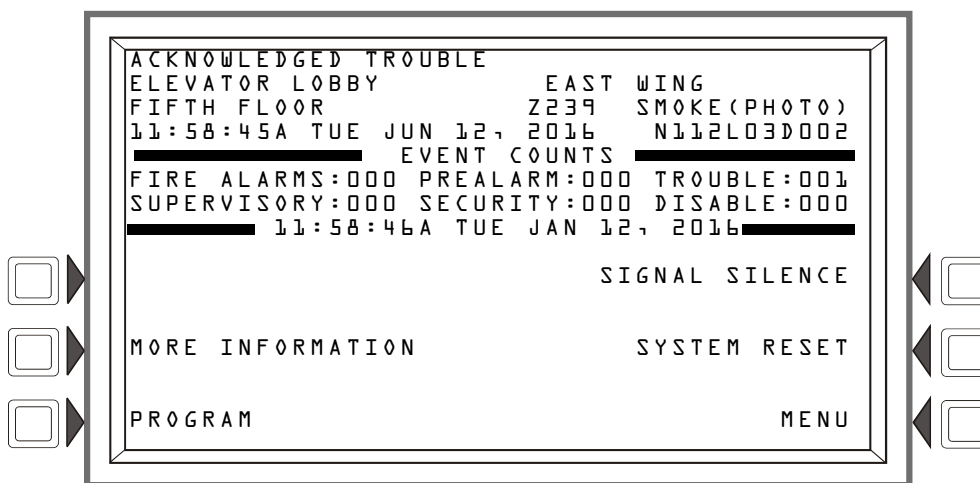

Figure 8.1 Point Event Display Example

Under the event report message, the event counts section shows the counts for outstanding events. Line eight gives the current time. The soft keys may be used to deal with the event; their functions are described in Section 9.2.

System Events Format

When a system trouble occurs, a message, generated by the control panel, displays at the top of the LCD-160's screen, while soft keys display available functions that may be used to handle the event.

The top four lines contain event information, and are formatted as follows:

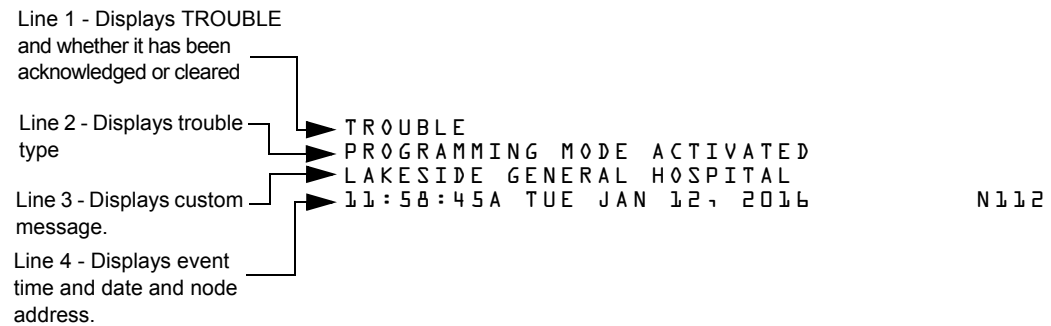

The system trouble event example screen below shows a ground fault condition.

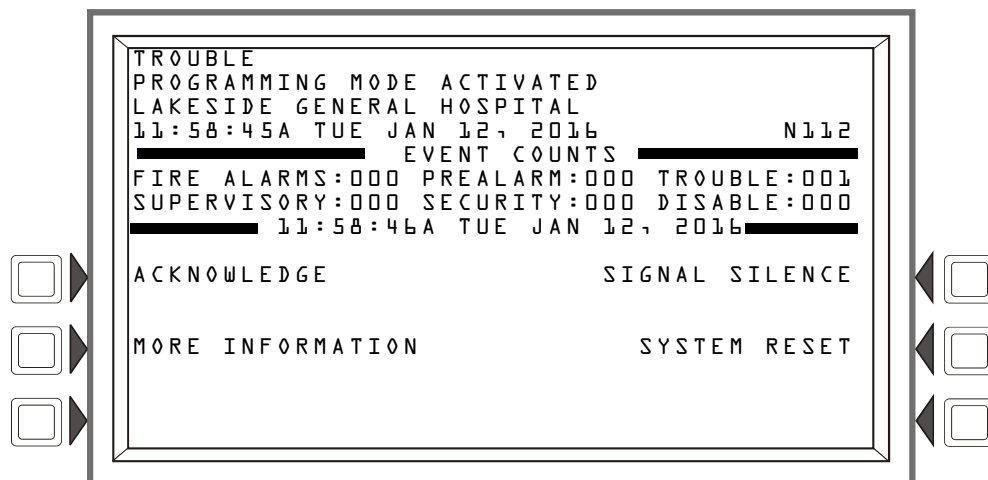

Figure 8.2 System Event Display Example

The event counts section shows the counts for outstanding events. The date in line eight gives the current time. The soft keys may be used to deal with the event; their functions are described in Section 9.2.

8.2 The Display and Control Center (DCC)

A Display and Control Center (DCC) is a display location which can respond to events occurring at other participating locations. While there may be multiple Display and Control Centers on a network, an individual location can only accept the commands of one DCC at a time. The user's actions at any participating station, panel, or remote display determine which location will be the DCC.

An LCD-160's DCC participation is set at the fire panel. If the panel associated with an LCD-160 has been programmed to participate in the DCC, all remote displays with Local Control ON will automatically participate. Refer to the panel programming manual for more information.

When an LCD-160 is not the DCC, pressing Signal Silence, System Reset, Acknowledge or Drill will automatically send a permission request to the current Display and Control Center (Figure). The DCC must release control to the requesting LCD-160 before the command can be processed

(Figure). If no DCC already exists, the command is processed and the acknowledging LCD-160 assumes control. An LCD-160 can only assert control over its associated panel. When a specific LCD-160 assumes control the **CONTROLS ACTIVE** LED illuminates.

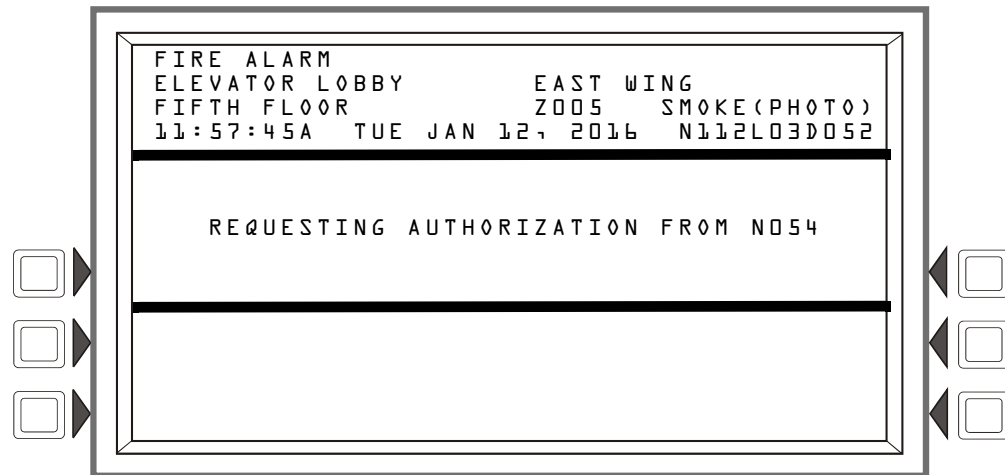

Figure 8.3 DCC Request Screen

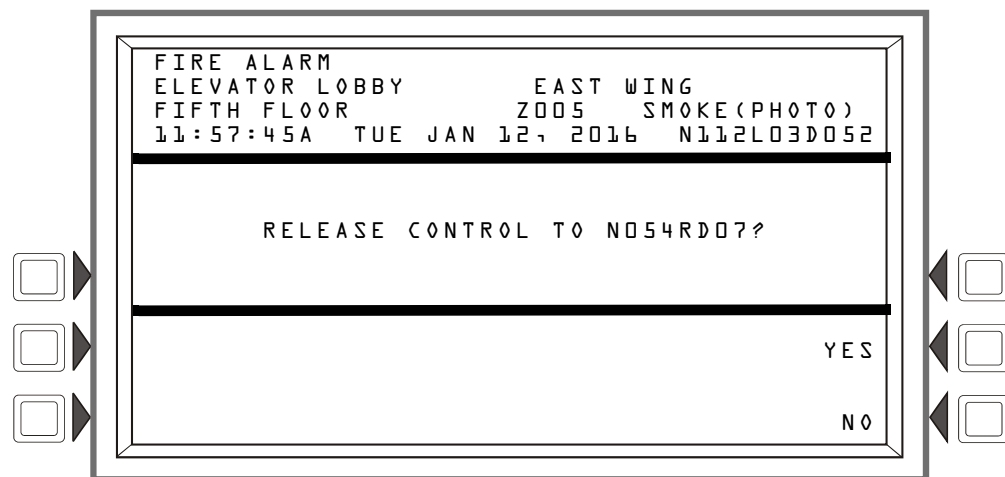

Figure 8.4 DCC Release Screen

YES - Press this key to release control to the requesting device.

NO - Press this key to deny control to the requesting device.



NOTE: If no key pressed within 15 seconds control is automatically released to requesting device.

8.3 Event Handling

When an event comes in, the piezo will sound (if enabled), the appropriate LED indicator will flash, and the Event Counts Screen will automatically display with the highest priority active event appearing at the upper left corner of the screen. If an event occurs while the Multiple Event Count List is active, lines one through four will display the unacknowledged event and line five will read PRESS ANY KEY. Multiple unacknowledged events are displayed in order of their priority. Within each event category, events are displayed in order of time occurrence.

8.3.1 Acknowledging an Event

When an off-normal event is sent to the LCD-160 from a panel, it must be acknowledged either at the LCD-160 or at the panel.

Press the **ACKNOWLEDGE** key to acknowledge an event. While in the “Event Counts” screen, you may also press the soft key labeled **ACKNOWLEDGE** to acknowledge an event. The next unacknowledged event (in order of priority) will display at the top of the screen. This process repeats until all events have been acknowledged.

There are two ways to acknowledge off-normal events: individually (event acknowledge) or as a group (block acknowledge).



NOTE: Local Control must be enabled at the panel for the LCD-160 to acknowledge an event.

Event Acknowledge

Event acknowledge acknowledges off-normal events one at a time; you must press the acknowledge key once for each event to be recognized. Fire and MNS alarms must always be individually acknowledged.

Block Acknowledge

Block Acknowledge acknowledges multiple events (other than fire alarms) with the press of a single button. Fire and MNS Alarms must always be individually acknowledged. A confirmation screen appears on all networked displays when events are block acknowledged. The Block Acknowledge setting is the default setting and is programmed at the fire panel.



NOTE: If the panel is programmed for Receive Mode, events and the clearing of events must be handled one at a time: each event must be acknowledged, and each clear (whether the clear occurs automatically or as the result of a panel reset) must be acknowledged.
Refer to the appropriate panel manuals for more information.

8.3.2 Types of Events

Events that are displayed on the LCD screen can be divided into the following fundamental categories:

- Fire Alarm Events
- Pre-Alarm Events
- Security Events
- Supervisory Events
- MNS Alarm Events
- Trouble Events
- Disable Events
- Other Events
- CO Alarm Events

Refer to the panel Operations manual for more information on each of these events.

Section 9: Screen Displays

9.0.1 The Main Menu

The “Main Menu” screen is the means by which the programmer can access displays and programming menus. This screen displays upon power up. It is accessible via the **MAIN MENU** soft key on the “Graphic Screen”, the “Event List” screen and from most other screens by pressing the **BACK** soft key until it displays.

The System Normal message appears at the top of the display when no off-normal events exist. If an acknowledged event exists, the LCD-160 will display it in the event reporting format as described on page 25.

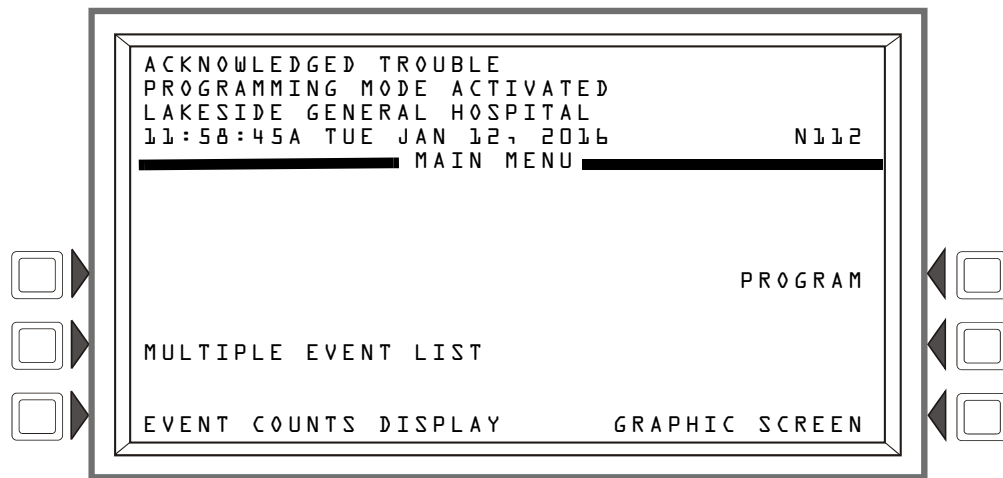

Figure 9.1 Main Menu Screen

■ Soft Keys

MULTIPLE EVENT LIST - Press this key to display the “Multiple Event List.” (See page 37.)

EVENT COUNTS DISPLAY - Press this key to go to the “Event Counts Display.” (See page 34.)

PROGRAM - Press this key to go to the “Panel Program” screen. This option will not be visible if any unacknowledged fire alarms exist or if the programming switch is disabled. (See pages 31–32.)

GRAPHIC SCREEN - Press this key to display the “Graphic Screen.” This key will not be available while there are any off-normal events. (See page 30.)

9.0.2 The Graphic Screen

The LCD-160 allows for custom graphics. Pressing the soft key to the right of **GRAPHIC SCREEN** on the Main Menu brings up the “Graphic Screen.”

While in the Graphic Screen, the System Normal message appears at the top of the display when no off-normal events exist. When any new event occurs, the “Event Counts Display” automatically displays. If an acknowledged event exists, it will display in the event reporting format as described on page 25.

Refer to the “Banner Editor” topic in VeriFire Tools Online Help for more information about creating and downloading custom graphics.

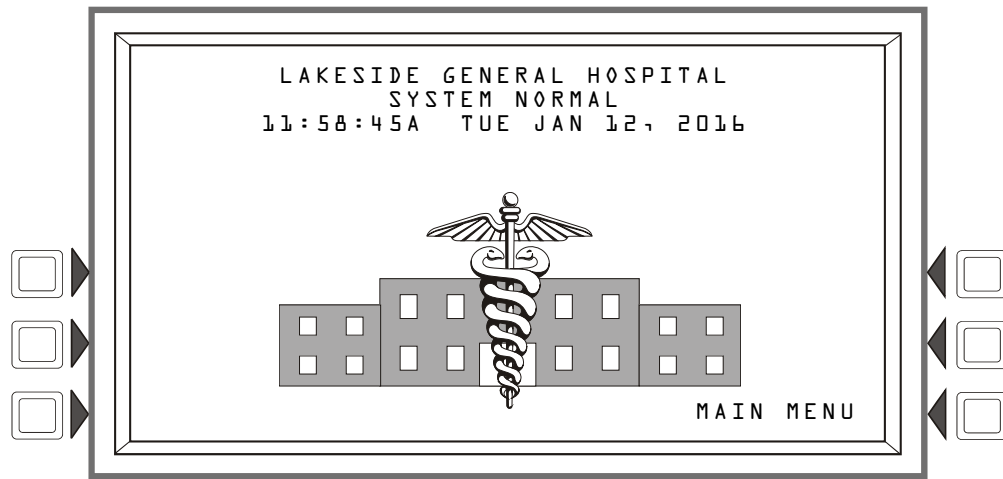

Figure 9.2 Graphic Screen (No Off-Normal Events)

■ **Soft Keys**

MAIN MENU - Press this key to display the “Main Menu.” The text of this soft key will appear over any graphic that extends into the last line of the display.

9.1 Programming Screens

Once the system has been physically installed, programming may begin. The user may program an LCD-160 at anytime, except while there is an unacknowledged alarm present.

9.1.1 Setting the Programming Switch

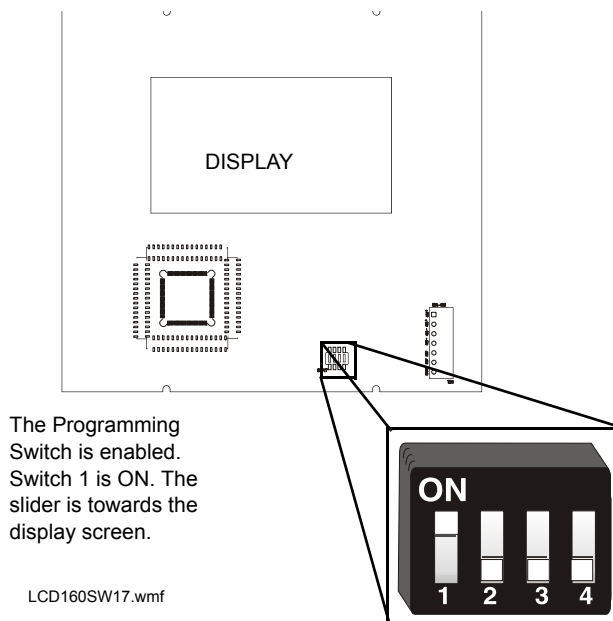

The Programming Switch is enabled. Switch 1 is ON. The slider is towards the display screen.

LCD160SW17.wmf

The LCD-160’s programming switch must be enabled to program the LCD-160.

Set dip switch 1 on SW17 to permit programming on the LCD-160. SW17 is located on the bottom edge of the LCD-160 board. To enable, use a small screwdriver to slide the switch up towards the display. To disable, slide the switch down away from the display.

Figure 9.3 SW17(Programming Switch Enabled)



NOTE: Switches 3 and 4 **MUST** remain in the disabled position.

Programming screens, such as “Panel Programming” and “LCD Display” are not available unless the programming switch is enabled. Once programming is completed, the switch must be “locked” back into the non-programming position.



NOTE: Enabling the programming switch will cause a “Remote Display” trouble.

9.1.2 Panel Program Menu

Pressing the soft key to the right of **PROGRAM** on the “Main Menu” brings up the “Panel Program Menu.” Use this screen to set the LCD-160’s RDP circuit address and program local settings on the LCD-160. This screen is only available when the Programming switch (SW17) is enabled. Refer to “Setting the Programming Switch” on page 31.

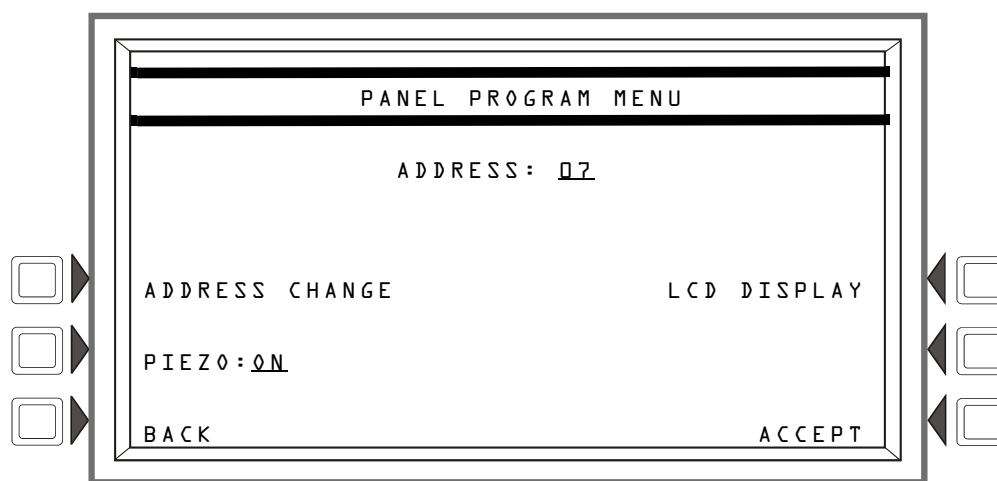

Figure 9.4 Panel Program Menu Screen

■ Soft Keys

ADDRESS CHANGE - Press this key to increase the LCD-160’s address on the RDP bus. The address will cycle from 1 to 32.

PIEZO - Press this key to toggle the status of the piezo between **OFF** and **ON**.

LCD DISPLAY - Press this key to go to the “LCD Display” menu.

ACCEPT - Press this key to accept changes programmed in “Panel Program Menu” and “LCD Display.” A confirmation screen will display before your new settings are saved.

BACK - Press this key to return to the previous screen without saving information entered.



NOTE: Each device on the RDP bus must have a unique address.

9.1.3 LCD Display

Pressing the soft key to the right of **LCD DISPLAY** on the “Panel Program Menu” brings up the “LCD Display” screen. Use this screen to program the LCD-160’s screen settings. The “LCD Display” is only available when the Programming switch (SW17) is enabled.

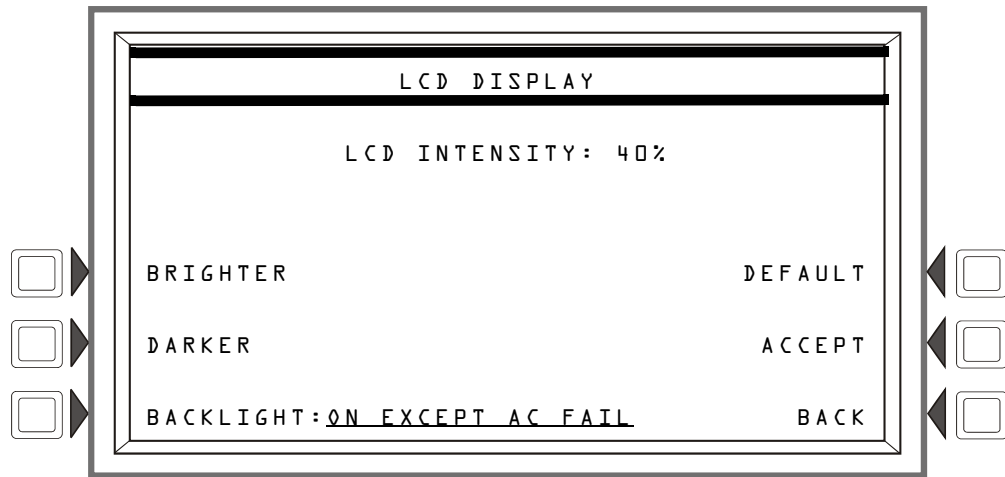

Figure 9.5 LCD Display Screen

■ **Soft Keys**

BRIGHTER - Press this key to increase the display intensity by 4%.

DARKER - Press this key to decrease the display intensity by 4%.

BACKLIGHT - Pressing this key toggle the status of the backlight between **ON**, **OFF**, and **ON EXCEPT AC FAIL**.



NOTE: **ON EXCEPT AC FAIL** refers to a failure at the panel's main power supply.

DEFAULT - Press this key to revert all screen preferences to their factory settings.

ACCEPT - Press this key to accept your changes. A confirmation screen will display before your new settings are saved.

BACK - Press this key to return to the previous screen without accepting information entered.



NOTE: During a LAMP TEST, the backlight will not turn on if it is programmed to OFF.

9.1.4 Programming Confirmation Dialog

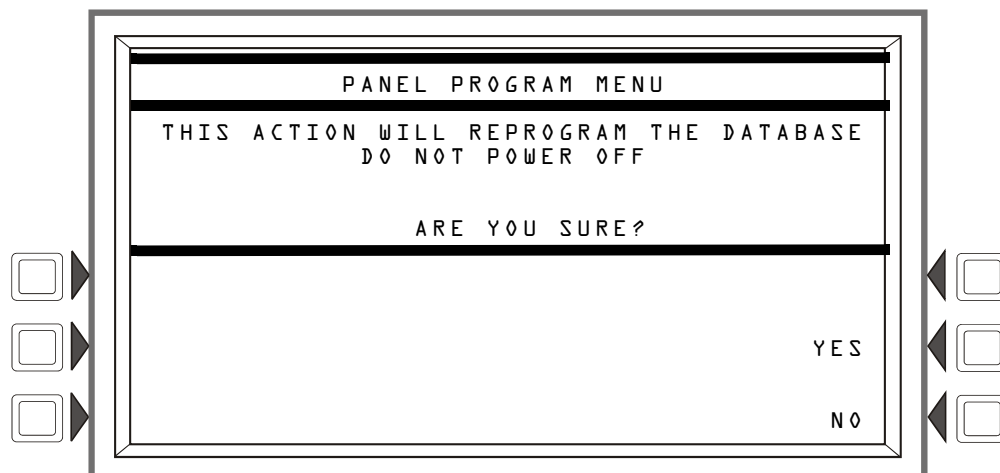

Figure 9.6 Programming Confirmation Screen

The LCD-160 displays the Programming Confirmation dialog when the user presses the **ACCEPT** soft key on the “Panel Program Menu” or “LCD Display” screen. It asks programmers to confirm any changes to the LCD-160 database and reminds them not to power off the system during the update.

■ Soft Keys

YES - Press this key to write the changes you made in the “Panel Program Menu” and the “LCD Display” screen to the database.

NO - Press this key to return to the “Panel Program Menu” without saving any new information to the database.



WARNING:
POWERING OFF DURING AN UPDATE WILL CORRUPT THE LCD-160'S DATABASE AND MAY CAUSE CATASTROPHIC FAILURE.

9.2 Operating Screens

These screens are used in the general operation of the LCD-160.

9.2.1 Event Counts Display

Pressing the soft key to the left of **EVENT COUNTS DISPLAY** on the Main Menu brings up the “Event Counts” screen. This screen can be displayed anytime including when no off-normal events exist. It will automatically display if an off-normal event requiring acknowledgement occurs. Fire alarm events, however, will display even in programming mode.

Lines one through five display the system normal message when no off-normal events exist. If an any off-normal event occurs lines one through five will display the event using the event reporting format (See “Event Reporting Format” on page 25). Lines six and seven display current counts of off-normal events in six categories. The counts include both acknowledged and unacknowledged events. During an off-normal event, line eight will display the current time and date.

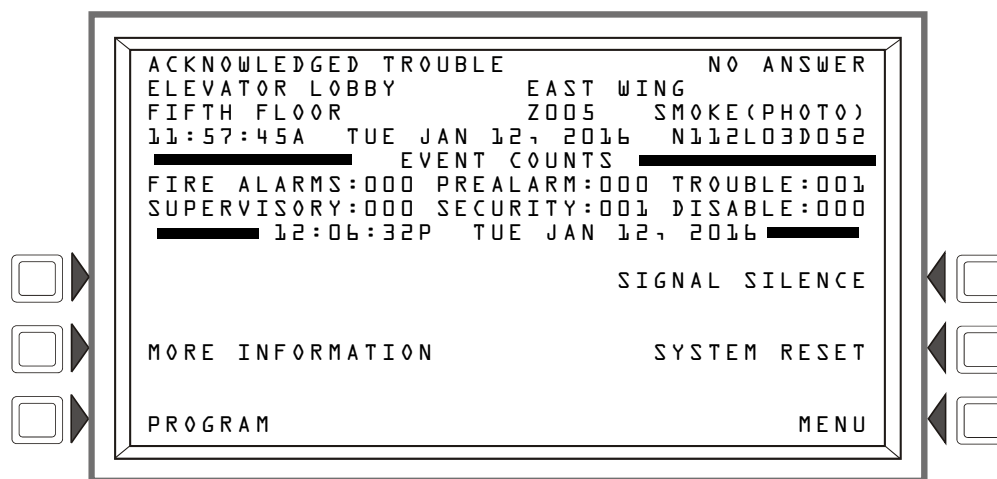

Figure 9.7 Events Count Display Screen (with Acknowledged Event)

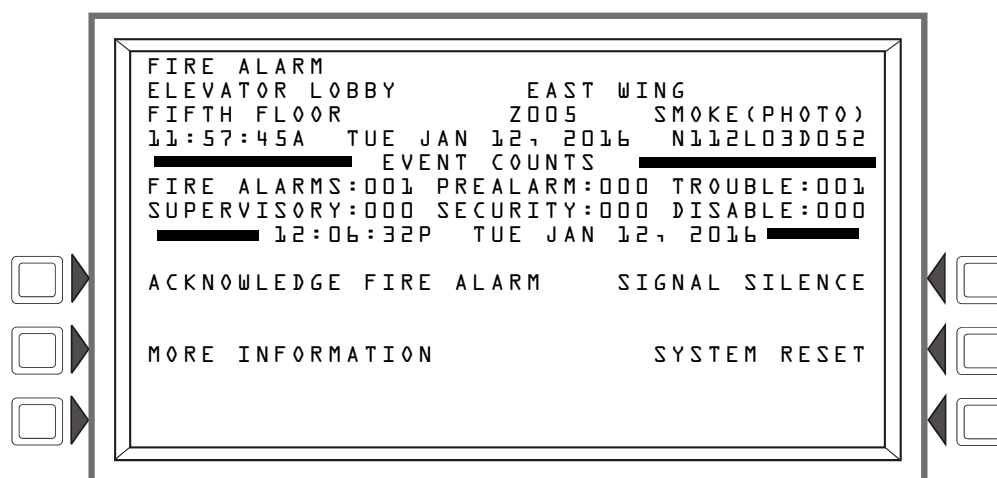

Figure 9.8 Event Counts Display (with Unacknowledged Fire Alarm)

■ **Soft Keys**

ACKNOWLEDGE - Press this key to acknowledge an event. The command will read **ACKNOWLEDGE FIRE ALARM** if the event is a fire alarm. It will read **ACKNOWLEDGE** if the event is any other type. The command will not display if there are no events to acknowledge.

MORE INFORMATION - Press this key to view additional device or event information on the “More Information” screen.

PROGRAM - Press this key to go to the “Panel Program Menu.” This option will not be visible if any unacknowledged fire alarms exist or if the programming switch is not enabled. See “Setting the Programming Switch” on page 31.

SIGNAL SILENCE - Press this key to silence all panel outputs programmed as silenceable.

SYSTEM RESET - Press this key to send a reset command to the panel and to clear the LCD-160 database of all off-normal events. If both Fire and MNS conditions are present on the panel, a second System Reset is needed to clear the alarms from the panel.

MENU - Press this key to return to the “Main Menu.” This option will not be visible if an unacknowledged event exists.

9.2.2 More Information

Pressing the soft key to the left of **MORE INFORMATION** on the “Event Counts Display” brings up the “More Information” screen. This screen contains additional information about the event shown in the Event Reporting Format.

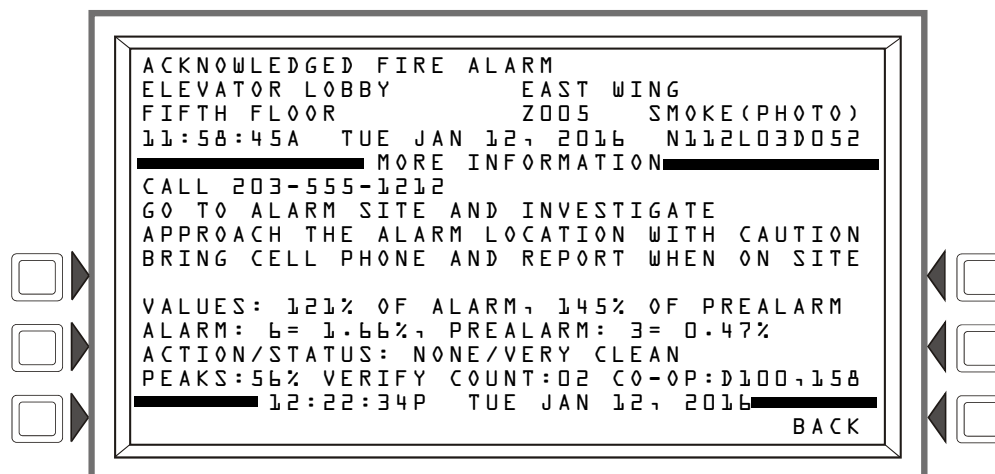

Figure 9.9 More Information Screen

Lines 1- 4 - Event information displayed in the Event Reporting Format. See “Event Reporting Format” on page 25.

Lines 6 through 9 - The Custom Action Message programmed for the point in alarm

Line 11 and 14 - These lines exist only for smoke/heat detectors. They do not display for wireless smoke detectors.

Line 11

values:

121% OF ALARM - This field gives the detector reading as it relates to its preprogrammed alarm level value (indicated in the next line on the screen). The example above shows the detector exceeding the alarm level by 21%.

145% OF PREALARM - This field gives the detector reading as it relates to its preprogrammed prealarm level value (indicated in the next line on the screen). The example above shows the detector exceeding the prealarm level by 45%.

Line 12

ALARM: 6=1.66% - Six is the preprogrammed alarm level value for this detector: its value is 1.66%, indicating the percent per foot obscuration value assigned to level 6.

PREALARM: 3=0.47% - Three is the preprogrammed pre-alarm level value for this detector: its value is 0.47%, indicating the percent per foot obscuration value assigned to level 3.

Line 13

ACTION/STATUS: NONE/VERY CLEAN - This displays the maintenance status of the device. The message that appears in this field depends on the drift compensation value. A detector will automatically compensate for environmental contaminants and other factors over time, until the tolerance value has been exceeded. The panel will signal a trouble condition when this level has been reached. Refer to the following table for messages and required action.

Message	Description
Replace/Malfunction	Replace the defective detector. The detector may not operate properly.
None/Very Clean	No action necessary. The detector readings are near ideal.
None/Clean	No action necessary. Although not ideal, the detector will activate at the selected sensitivity level.
None/Fairly Clean	No action necessary. The detector will activate at the selected sensitivity level.
Needs Cleaning	Clean the detector soon. The detector may cause a false alarm because it has reached the drift compensation tolerance value.
Needs Immediate Cleaning	Clean immediately! The detector is a false alarm risk. The drift compensation tolerance value has been exceeded.

Line 14

PEAKS : 56% - This value represents the highest percent per foot obscuration reading taken by this detector. It can be a historical figure, and does not necessarily represent the highest reading for this particular alarm. Re-initializing the detector would reset this value to zero.

VERIFY COUNT : 02 - This displays the number of times the detector has gone into alarm. This count aids in differentiating false alarms from actual alarms by showing repeated alarm events that have come into the device. In this example, the detector has gone into alarm two times since the verification count was begun. The FACP will signal a trouble condition when the verify count is exceeded. Displays as **COUNT** for FSC-851 Intelliquad detectors.

CO-OP : D100, 158 - Indicates the address(es) of any detector(s) linked with the detector that's in alarm for Co-operative Multi-alarm Sensing. This field does not display for Acclimate detectors, FSC-851 Intelliquad detectors, Beam detectors or Heat detectors.

CO : - FSC-851 Intelliquad detector only, FlashScan only - Carbon Monoxide reading in parts per million.

TEMP : - Displays degrees Fahrenheit for Acclimate, heat, and FSC-851 detectors

Line 15 - The current time and date are displayed in this line.

Line 16

BACK - Press to return to the previous screen.

9.2.3 Multiple Event List Display

Pressing the soft key to the left of the **MULTIPLE EVENTS LIST** message on the Main Menu brings up the "Multiple Events List" screen. The Multiple Event List shows off-normal events simultaneously in groups of eight. An event is shown at the top, and seven are shown in the list below it. (When no unacknowledged or off-normal events exist, lines one through four display the system normal message.) Line five displays the featured event's type and its sequence within events of the same type. Lines 6 through 12 display a list of events, their order of occurrence, type, and point labelling. The priority of event types is determined by the programmed Event Ordering setting (USA or Canada).

With Fire as the highest priority:	
USA Event Order	Canada Event Order
Fire	Fire
CO Alarm	CO Alarm
MN Alarm	
CO Pre-alarm	CO Pre-alarm
Security	—
Supervisory	Supervisory
MN Supervisory	
Trouble	Trouble
MN Trouble	
Pre-alarm	Pre-alarm
Disabled	Disabled

With MNS as the highest priority:	
USA Event Order	Canada Event Order
MN Alarm	
Fire	Fire
CO Alarm	CO Alarm
CO Pre-alarm	CO Pre-alarm
Security	—
MN Supervisory	
Supervisory	Supervisory
MN Trouble	
Trouble	Trouble
Pre-alarm	Pre-alarm
Disabled	Disabled

Note: Fire/MNS priority dependent on fire panel programming. Refer to the fire panel programming manual for additional information.

Line 14 displays current counts of off-normal events in three categories: **ALARM**, **SUPERVISORY**, and **TROUBLE**. The counts include both acknowledged and unacknowledged events.

Pressing one of the Scroll Display fixed function keys will cause the first event of that type (e.g., alarm, trouble, etc.) to display at the top, and subsequent events of that type to display in sequence below it. It will also change the **MAIN MENU** soft key to **SCROLL BACK**. Press the key again to begin scrolling. If there are no events of the type denoted by the Scroll Display key, pressing the key will have no effect. Pressing the **SCROLL BACK** soft key will scroll the list back one event.

If an unacknowledged or off-normal event occurs while this screen is active, lines one through four will display the event in the event reporting format (See “Event Reporting Format” on page 25). Line five will read **PRESS ANY KEY**. Pressing any key will return the display to the “Event Counts” screen.



NOTE: Pressing the **ACKNOWLEDGE** hard key when there is an off-normal event will only return the display to the “Event Counts” screen. It will not acknowledge the off-normal event. An off-normal event can only be acknowledged from the “Event Counts” screen.

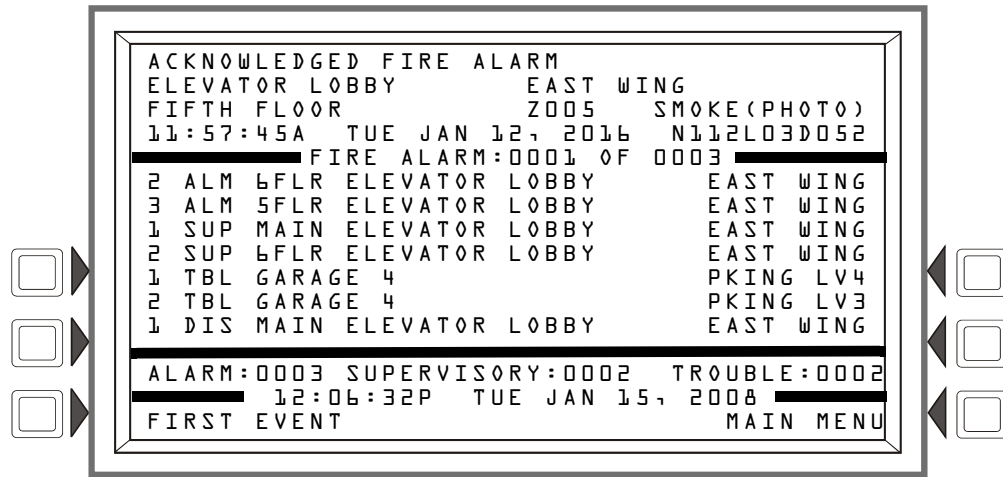

Figure 9.10 Multiple Events List Display Screen

■ **Soft Keys**

FIRST EVENT - Press this key to display the first active of the type shown on line one. If the soft key **SCROLL BACK** is displayed, it will change to **MAIN MENU**.

SCROLL BACK (MAIN MENU) - Press this key to scroll backwards through an event list. This option will change to **MAIN MENU** when the **FIRST EVENT** key is pressed.

9.3 Service Screens

9.3.1 Version Information

Software version information may be displayed by pressing the **LAMP TEST** key on the keyboard for more than three seconds. The following screen will appear while the **LAMP TEST** key is pressed.

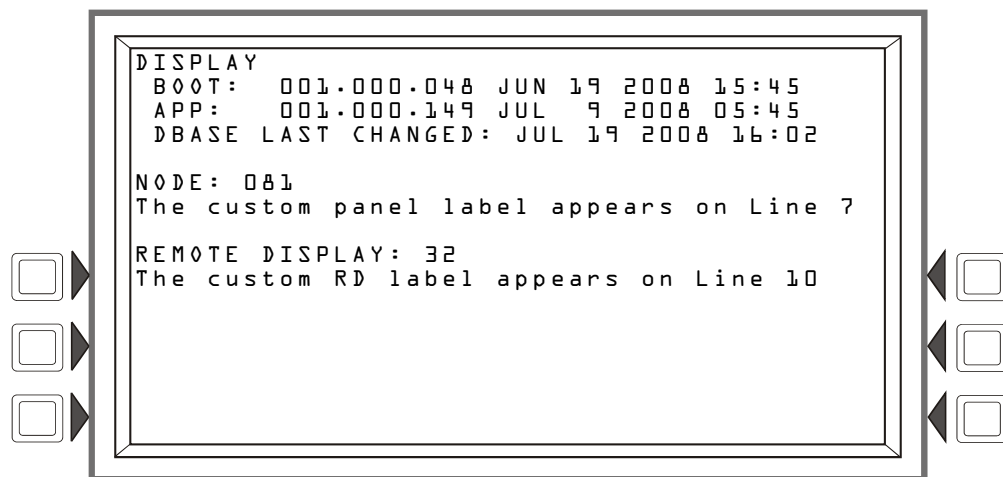

Figure 9.11 Version Screen

9.3.2 Power-up Screen

The Power-up screen appears when the panel is powering up. During power-up, a series of self-tests are performed internally: the tests and the results of the tests appear on the screen as they are completed. Failure of a test may prevent the LCD-160 from performing its functions. Holding the **DRILL** key during the power up will reset all settings (including address information) to the factory defaults.

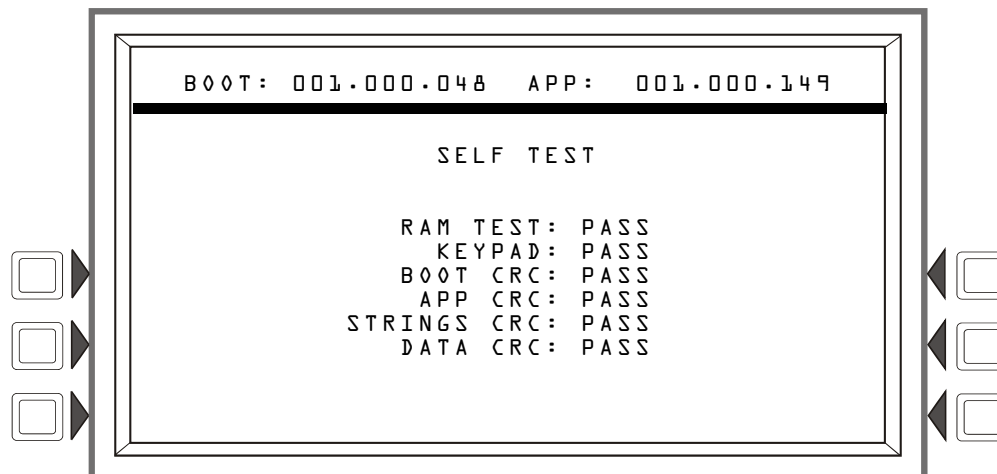

Figure 9.12 Self Test Screen



NOTE: The Power-up screen will display if the LCD-160 loses communication with the host panel during a download.

9.3.3 Download Screen

The “Download” screen appears immediately before a download. Downloading is initiated at the panel.

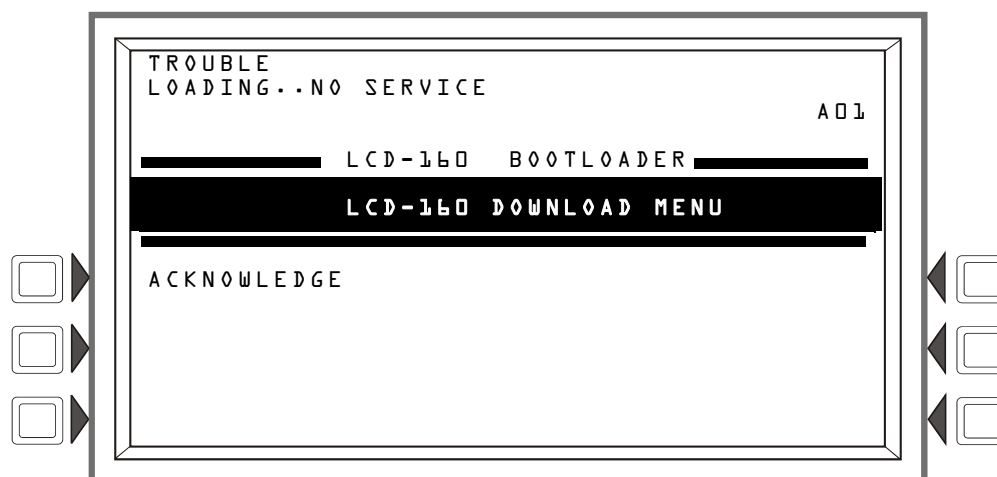

Figure 9.13 Download Menu Screen

ACKNOWLEDGE: Press this soft key to acknowledge troubles and silence the piezo. You may use the **TROUBLE** scroll/display key to list individual troubles.

9.3.4 Download Application Screen

This screen is displayed during application downloads. Downloading is initiated at the panel. The progress meter shows the progress of the current download.

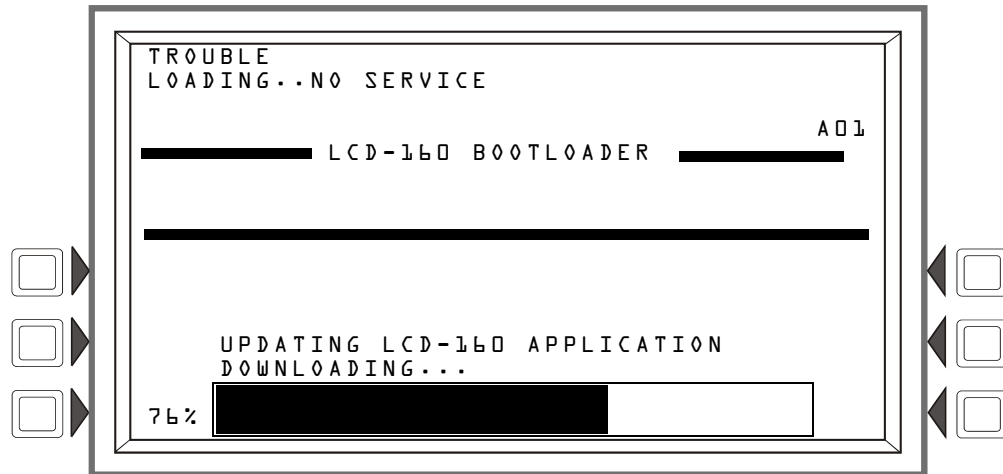

Figure 9.14 Download Application Screen

9.3.5 Download Bootloader Screen

This screen is displayed during bootloader downloads. Downloading is initiated at the panel. The progress meter shows the progress of the current download.

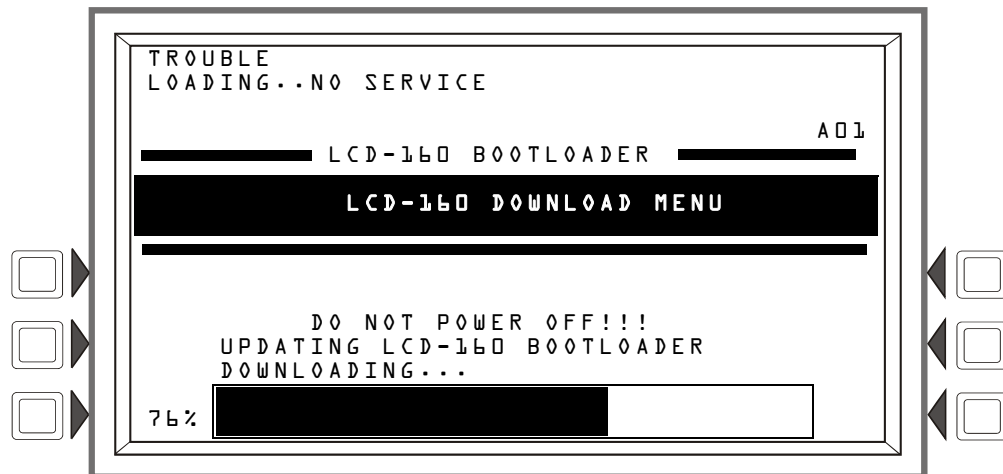

Figure 9.15 Download Bootloader Screen

9.3.6 Download Strings Screen

This screen is displayed during strings downloads. Downloading strings is initiated at the panel. The progress meter shows the progress of the current download.

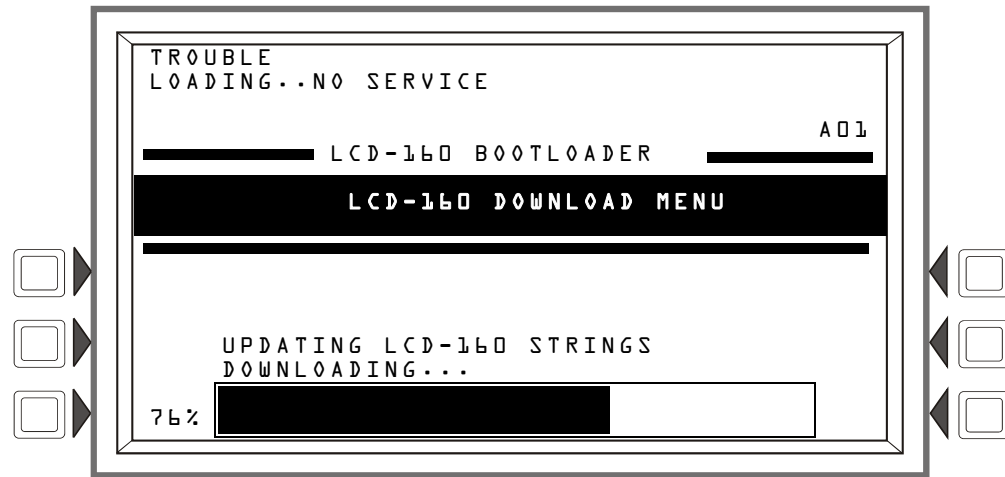

Figure 9.16 Download Strings Screen

9.3.7 Application Corrupt Screen

During power-up, the panel checks the application code. If the code is corrupt, the panel cannot proceed, and the following screen is displayed. The user must use *VeriFire Tools* to download the application code. Usually this screen results from a power interrupt during a critical period of application download. The Trouble LED will flash and the piezo (if enabled) will sound while this screen is in effect. All corrupt images will activate the corresponding system trouble. Pressing the Trouble Scroll button will scroll through all system troubles.

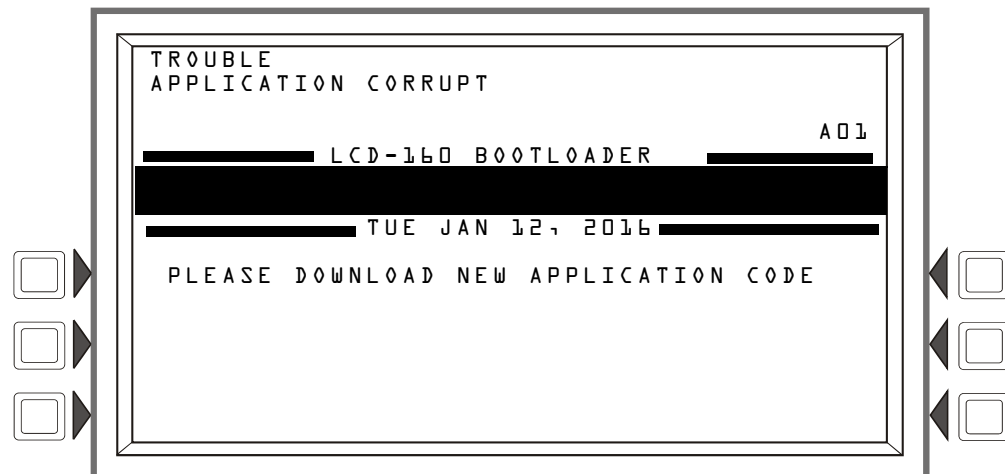

Figure 9.17 Application Corrupt Screen

Appendix A: LCD-160 Power Requirements

An LCD-160 draws its power from the power supply and must be considered when calculating the primary and secondary power supply requirements for the system. Each LCD-160 is accounted for in the power calculations outlined in the respective installation manual. However, if the current draw dedicated to all LCD-160s must be calculated as a separate figure, use the equations in Table A.1.

Electrical Ratings

Input Voltage: 24 VDC (must be non-resettable).

Data Communications Port:

RDP interface (power-limited/Class 2).

Non-Fire Alarm Status A: Power LED is on; backlight is off	
Number of LCD-160 modules	$[\quad] \times 0.075 \text{ A} = [\quad] \text{ amps}$
Non-Fire Alarm Status B: Power LED is on; backlight is also on	
Number of LCD-160 modules assumed to have points active simultaneously	$[\quad] \times 0.300 \text{ A} = [\quad] \text{ amps}$
Total LCD-160 Standby Current = $[\quad] \text{ amps}$	
Fire Alarm Status (All LEDs and pixels are assumed to be on)	
Number of LCD-160 modules assumed to be in alarm simultaneously	$[\quad] \times 0.325 \text{ A} = [\quad] \text{ amps}$
Total LCD-160 Fire-Alarm Current = $[\quad] \text{ amps}$	

Table A.1 LCD-160 Current Draw

Index

A

ABF-2B **12, 15**
ABF-4B **12, 15**
ABS-2D **12, 15**
ABS-2DR **12**
ABS-4D **12, 15**
ABS-4DR **12**
Acknowledge
 block and point **29**
 fixed function key **23**
Action/Status, detector **36**
Address, changing **32**
ADP-4, ADP-4B **13**
AKS-1(B), *see* Key switch
Annunciator key switch, *see* Key switch
Application **41**
Application Corrupt Screen **42**

B

Backboxes **12, 15**
Backlight **33**
Board Layout **10**
Bootloader **41**

C

CAB-4 Series backbox **12, 15**
Cabinet mounting **15**
Canada Event Order **38**
CO Alarm Event **29**
Contrast, *see* LCD Display **32**
Controls Active, LED indicator **24, 28**
Co-operative Multi-Alarm Sensing display **37**
Current, *see* Power Requirements
Custom Action Message **36**

D

DCC, *see* Display and Control Center
Detector
 Co-operative Multi-alarm Sensing **37**
 Peaks display **37**
 Verify Count display **37**
Detector information **36–37**
DIP Switch, *see* SW17
Disabled Point events
 and Other Event Scroll/Display key **23**
Display and Control Center **23, 27–28**
Display intensity **33**
Download screens **40–41**
DP-DISP **13**
Dress Panels **13, 15**
Drill

 and Power-up screen **40**
 fixed function key **23**

E

Earth Ground **19**
Electrical connections **16, 18, 20**
Electrical ratings **43**
ELR, *see* End-of-Line Resistor
End-of-Line Resistor **18**
Event counts **26**
Event Counts display **34**
Event Ordering **37**
Event reporting format **25**
 point events **25**
 system events **27**
Event types **29**

F

Fire Alarm events **29**
 event format **26**
 LED indicator **24**
 SCROLL/DISPLAY key **23**
First Event **39**
Fixed Function Keys, overview **23**

G

Graphic screen **30**

I

Installation Standards and Codes **8**
Interface **22**

K

Key switch **21**
 location **10**
Keypad **22**

L

Lamp Test **33, 39**
 fixed function key **23**
LCD Display **32**
LED Indicators
 Diagnostic **11**
 Status **22, 24**
Local Control **27**

M

Main Menu **30**
Message Formats, about **25–27**

Microfail, LED indicator **11**
 MNS Alarm Event **29**
 More Information (screen) **36**
 Mounting **15**
 Multiple Event List Display **37**
 Multiple power supplies **21**

N

NUP
 terminal location **10**

O

Off-normal events **25**
 Operating Screens **34–39**
 Other event **29**
 event format **26**
 LED indicator **24**
 SCROLL/DISPLAY key **23**
 Overview
 Backboxes **12**
 Fixed Function Keys **23**
 Installation **11**
 Soft Keys **22**

P

Panel Program Menu **32**
 Piezo **32**
 Point Disabled events **29**
 event format **26**
 LED indicator **24**
 Point events format **25**
 Power
 LED indicator **24**
 terminal location **10**
 Power connections **20**
 Power Requirements **43**
 Power-up Screen **40**
 Pre-Alarm events **29**
 and Other Event Scroll/Display key **23**
 event format **26**
 LED indicator **24**
 Product Diagram **10**
 Programming Confirmation Dialog **34**
 Programming Screens **31–34**
 Programming Switch, *see also* SW17

R

RDP **17–18**
 terminal location **10**
 Receive Mode **29**
 Receive, LED indicator **11**
 Remote Data Port, *see* RDP

S

Scroll Back **39**
 SCROLL/DISPLAY keys **23**
 Security events **29**
 event format **26**
 LED indicator **24**
 SCROLL/DISPLAY key **23**
 Self-Test Screen *see* Power-Up Screen
 Service Screens **39–42**
 Shielding **18**
 Signal Silence
 fixed function key **23**
 Signals Silenced
 LED indicator **24**
 Soft Keys, overview **22**
 Software **39**
 Specifications
 Communication **17**
 Electrical Ratings **43**
 Power **43**
 Status LEDs **22**
 Status, LED indicator **11**
 Strings **41**
 Supervisory events **29**
 event format **26**
 LED indicator **24**
 SCROLL/DISPLAY key **23**
 Surface-Mount Backboxes **12**
 SW17
 location **10**
 setting **31**
 System event format **27**
 System Reset
 fixed function key **23**
 System Trouble
 LED indicator **24**

T

Transmit, LED indicator **11**
 Trouble events **29**
 event format **26**
 SCROLL/DISPLAY key **23**

U

USA Event Order **38**

V

Values, detector **36**
 VeriFire Tools **30**
 Version Information **39**

W

Wiring **15, 20, 21**
 Non-power-limited **16**

Power-limited (Class 2) **16**
RDP **17**

Manufacturer Warranties and Limitation of Liability

Manufacturer Warranties. Subject to the limitations set forth herein, Manufacturer warrants that the Products manufactured by it in its Northford, Connecticut facility and sold by it to its authorized Distributors shall be free, under normal use and service, from defects in material and workmanship for a period of thirty six months (36) months from the date of manufacture (effective Jan. 1, 2009). The Products manufactured and sold by Manufacturer are date stamped at the time of production. Manufacturer does not warrant Products that are not manufactured by it in its Northford, Connecticut facility but assigns to its Distributor, to the extent possible, any warranty offered by the manufacturer of such product. This warranty shall be void if a Product is altered, serviced or repaired by anyone other than Manufacturer or its authorized Distributors. This warranty shall also be void if there is a failure to maintain the Products and the systems in which they operate in proper working conditions.

MANUFACTURER MAKES NO FURTHER WARRANTIES, AND DISCLAIMS ANY AND ALL OTHER WARRANTIES, EITHER EXPRESSED OR IMPLIED, WITH RESPECT TO THE PRODUCTS, TRADEMARKS, PROGRAMS AND SERVICES RENDERED BY MANUFACTURER INCLUDING WITHOUT LIMITATION, INFRINGEMENT, TITLE, MERCHANTABILITY, OR FITNESS FOR ANY PARTICULAR PURPOSE. MANUFACTURER SHALL NOT BE LIABLE FOR ANY PERSONAL INJURY OR DEATH WHICH MAY ARISE IN THE COURSE OF, OR AS A RESULT OF, PERSONAL, COMMERCIAL OR INDUSTRIAL USES OF ITS PRODUCTS.

This document constitutes the only warranty made by Manufacturer with respect to its products and replaces all previous warranties and is the only warranty made by Manufacturer. No increase or alteration, written or verbal, of the obligation of this warranty is authorized. Manufacturer does not represent that its products will prevent any loss by fire or otherwise.

Warranty Claims. Manufacturer shall replace or repair, at Manufacturer's discretion, each part returned by its authorized Distributor and acknowledged by Manufacturer to be defective, provided that such part shall have been returned to Manufacturer with all charges prepaid and the authorized Distributor has completed Manufacturer's Return Material Authorization form. The replacement part shall come from Manufacturer's stock and may be new or refurbished. THE FOREGOING IS DISTRIBUTOR'S SOLE AND EXCLUSIVE REMEDY IN THE EVENT OF A WARRANTY CLAIM.

Warn-HL-08-2009.fm



World Headquarters
12 Clintonville Road
Northford, CT 06472-1610 USA
203-484-7161
fax 203-484-7118

www.notifier.com

ISO 9001
CERTIFIED
ENGINEERING & MANUFACTURING
QUALITY SYSTEMS