

Lyric™ Controller

User Reference Guide

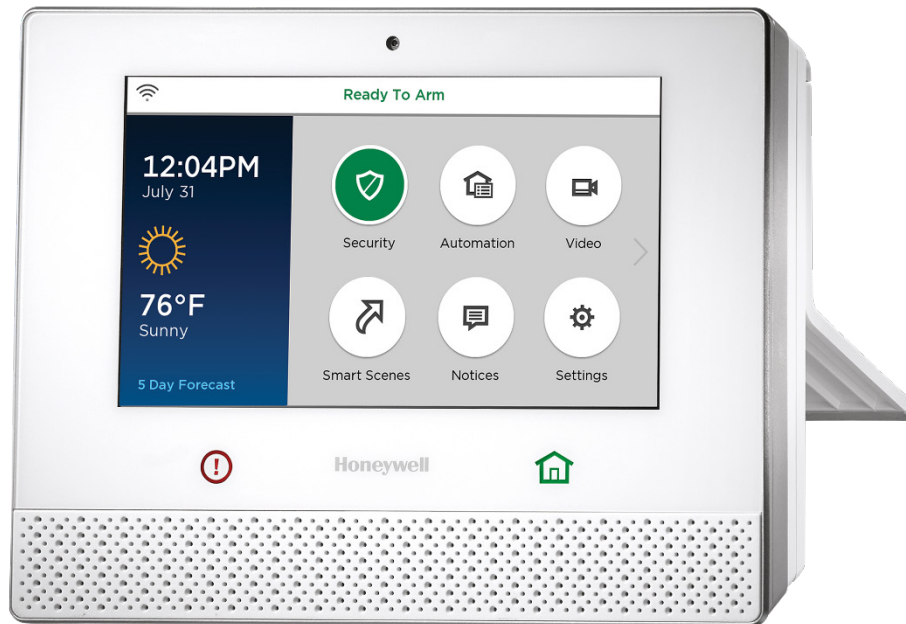

Ref: LCP500-L/LCP500-LC

800-18078 11/15 Rev. D

Honeywell

Your Honeywell security system is designed for use with devices manufactured or approved by Honeywell for use with your security system. Your Honeywell security system is not designed for use with any device that may be attached to your security system's control or other communicating bus if Honeywell has not approved such device for use with your security system. Use of any such unauthorized device may cause damage or compromise the performance of your security system and affect the validity of your Honeywell limited warranty. When you purchase devices that have been manufactured or approved by Honeywell, you acquire the assurance that these devices have been thoroughly tested to ensure optimum performance when used with your Honeywell security system.

Lyric™ Lock

Your system supports advanced features designed to keep it functioning optimally. These capabilities include: the ability to interact with Honeywell and your dealer's network for the setup and programming of its features, support for remote software updates and the ability (when enabled by your monitoring dealer) to enhance your security by preventing an unauthorized takeover of the system by another monitoring company. In the event that your dealer has enabled the feature to prevent an unauthorized takeover and you wish to authorize a new company to take over your system, you may request that Honeywell remotely disable this feature. Honeywell will require documentation that you have attempted to contact your existing security dealer and that they have failed to respond, or failed to agree to your request.

TABLE OF CONTENTS

OVERVIEW.....	5
About This Guide.....	5
Basic Functions.....	6
About the Control Panel.....	7
Home Button Status Indications.....	7
The Tools Menu.....	8
SECURITY.....	11
Security Features.....	11
False Alarm Prevention.....	12
Arming the System.....	13
Disarming the System.....	15
Bypassing Protection Zones.....	15
Entry and Exit Delays.....	16
Panic Alarms.....	17
Chimes/Voice Annunciations.....	18
Audio Alarm Verification (Two-Way Voice).....	19
Built-In Camera.....	19
AUTOMATION: Z-WAVE AND OTHER DEVICES.....	21
Working with Z-Wave Devices.....	21
Garage Doors.....	28
AUTOMATION: SMART SCENES.....	29
Smart Scenes and User Access.....	29
Creating a Smart Scene.....	30
Hold.....	33
Run.....	33
Show (Review).....	33
AUTOMATION: VOICE COMMAND.....	35
Setup.....	35
Voice Command Assignment.....	36
Using Voice Command.....	36
Counter (Sensitivity Settings).....	37
VIDEO.....	39
Viewing and Naming Cameras.....	39
Adding a Camera.....	39
Video Recovery.....	40
USERS AND SECURITY CODES.....	41
User Codes.....	41
Duress Code.....	41
Adding Users and Assigning Codes.....	42
Changing Security Codes or the Duress Code.....	42
Deleting a User.....	42
User Settings.....	43
SYSTEM SETTINGS.....	45
Brightness/Volume/Cleaning.....	45
Wi-Fi Configuration.....	45
Software Updates.....	46
Slide Show.....	47
Date / Time.....	47
Events.....	47
Keypad.....	48
TESTING YOUR SYSTEM.....	49
Testing Sensors (Walk Test).....	49
Testing Communications.....	50
Reboot.....	50
MAINTENANCE.....	51
Care and Cleaning.....	51
Battery Replacement.....	51
Communication Module Replacement.....	53

SYSTEM DISPLAY AND BUTTONS	55
WIRELESS KEYS	57
Key Assignments	57
SiXFOB Wireless Key Status Indications	57
EVENT LOG CODES	58
GLOSSARY	60
FIRE/CO ALARM SYSTEM	61
In Case of Fire	61
In Case of Carbon Monoxide Alarm	61
Silencing a Fire/Carbon Monoxide Alarm.....	61
NATIONAL FIRE PROTECTION ASSOCIATION SMOKE DETECTOR RECOMMENDATIONS	62
Emergency Evacuation.....	63
REGULATORY AGENCY STATEMENTS.....	64
OWNER'S INSURANCE PREMIUM CREDIT REQUEST	65
LIMITATIONS OF THIS ALARM SYSTEM.....	67
YOUR SYSTEM INFORMATION.....	68
TWO YEAR LIMITED WARRANTY	71

Overview

The Lyric Controller combines a security system and home automation with an easy to use interface. All functions can be operated from the Controller and many Lyric features can be accessed from internet-connected smart devices.

Security functions can be operated from optional wireless keys and wireless keypads.

Wireless and wired sensors provide burglary protection and smoke and combustion detectors provide early fire and carbon monoxide (CO) warnings.

Lyric monitors sensors and system status to initiate alarms and generate alerts. The system can also send alarm and status messages to a central monitoring station via the cellular phone network or the Internet. Lyric can also provide two-way voice communication with the central station.

Arming options	Use Away mode when no one will be home. Exterior doors and windows are protected; interior areas can be monitored by motion detectors. Use Stay mode to protect exterior doors and windows when the house will be occupied. Arming modes can be customized to exclude specific parts of the premises. Selected door/window and movement sensors can be excluded temporarily. Fire protection cannot be bypassed or suspended.
Panic buttons	Activate police and fire alarms or emergency alerts from the Controller, wireless keys or remote keypad. Panic modes can be customized by your installer.
Audio Alarm Verification	Talk directly to your central monitoring station from the Controller.
Video	Monitor and control compatible Wi-Fi® cameras. View video from as many as four cameras simultaneously.
User and Security Codes	4-digit codes allow Lyric to distinguish between users with different types of access to system functions. The Master User is typically a household member who can perform all normal system functions. Guest and other users each have unique codes.
Voice Commands	Use spoken trigger phrases to control Smart Scenes and video cameras.
Automation	Automate lights, locks and other compatible devices. <i>Some features can be operated remotely via remote services such as Honeywell Total Connect™.</i>
Smart Scenes	Easy-to-program combinations of security and automation features.
Message center	Record and play back voice messages.
Weather	Displayed on the touchscreen.
News and Traffic	<i>Requires remote services.</i>
Remote Keypad	Operate security functions from the Lyric Keypad. <i>(Optional)</i>
Remote Services	Remote monitoring and control functions from mobile devices or web browser. <i>Requires remote services plan.</i>
Built-in Camera	Lyric takes a snapshot of the person at the Controller when the system is disarmed. <i>Requires remote services.</i>

About This Guide

Throughout the guide, you will see these tips for finding the menus and controls you need.

For example, [Home](#) > [Security](#) > [Tools](#) > [Users](#)

Means: On the **Home** screen, select **Security**.

On the Security menu, select **Tools**.







On the Tools menu, select **Users**.

Note that the illustrations may differ slightly from your system.

Basic Functions

Press the  button below the touchscreen to return to the Home screen from other functions

Security



	Press
Security features	 on the Home screen
Arm in Stay mode	 and enter a user code
Arm in Away mode	 and enter a user code
Disarm system & silence alarms	 and enter a user code. Repeat to silence alarms/alerts
Panic	 on the Controller below the touchscreen . Then:  or  on the touchscreen

Other Panic modes may appear on the screen if they are programmed in your system





Video

Press  on the Home screen to view and configure Wi-Fi cameras

Control Panel Settings

Press  on the Home screen	
Screen brightness	Use the Brightness slider
Voice announcements volume	Select VOICE and use the slider
Chime volume (count-down beeps, other sounds)	Select CHIME and use the slider
Clean touchscreen	Touch  to disable all controls for 15 seconds





Automation Features

	Press
Operate & manage Z-Wave devices	 on the Home screen
Create & manage Smart Scenes	 on the Home screen
Use & manage Voice Commands	 then  then enter Master User code, then 

Using Voice Commands

Speak trigger phrase	Lyric confirms it has heard a trigger phrase. <i>Confirmation is optional. Three phrases are available and can be changed later.</i>
Speak command phrase	Lyric executes the operation associated with the command, confirms operation. <i>Five voice commands can be associated with Smart Scenes. The command "Cameras" launches the Video function.</i>

Common Master User Functions

Press  on the Home screen. On the Security menu, press  and enter Master User code.	
Add, delete or modify user codes	
System tests	 and select Walk Test or Comm. Test

About the Control Panel

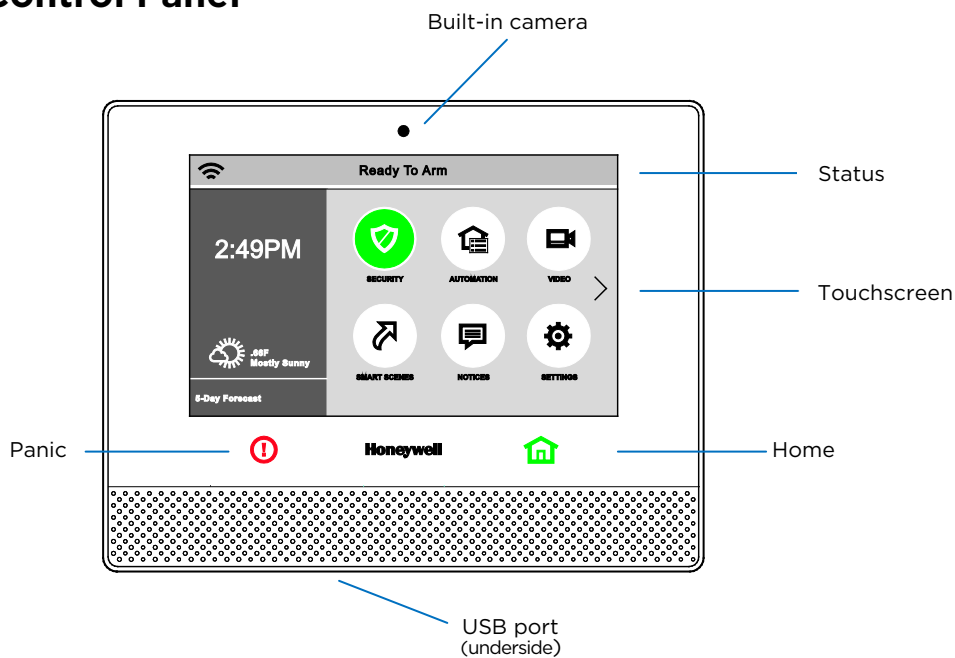

The display may vary with your connected devices and services.

- Security system status appears at the top of the screen.
- Communication status appears at top left.
- Time, date and local weather appear at left. Press **5 Day Forecast** for weather information.

The Home screen normally shows:

- **Security**: Arm and disarm the system with various options.
- **Automation**: Control lights, locks and other devices.
- **Video**: View and control Wi-Fi cameras.
- **Smart Scenes**: Customize and automate security and comfort features.
- **Notices**: View system updates and other information from your security company.
- **Settings**: Adjust **screen brightness and audible indicator volume**, hide controls for **screen cleaning**.

Press **>** for Help videos and other features.

NOTE: If the Controller loses AC power, playback of Help videos is disabled to minimize drain on the backup battery. If power is lost while you are watching a Help video, playback may continue.

Below the touchscreen:

Press **Home** to return to the Home screen.

Press **Panic** for Fire, Police and other emergencies.

NOTE: If the Controller loses AC power, the Home button begins to blink slowly after 15 minutes on battery backup (red if the system is armed, green if not armed). In this situation, the Panic button goes dark, but Panic functions remain available.

Home Button Status Indications

The Home button's internal LED indicates system status with these behaviors:

Green, steady	System is ready to be armed
Red, steady	System is armed
Green, blinking	System is disarmed, and not ready to be armed (fault or alarm exists)
Red, blinking	An Alarm condition exists.
Red/Green, blinking alternately	System is in Programming mode or Two-way Voice communication is active.

See the **Panic** section for information on silent alarms and the Home button.

Audible Indicators

Beeping sounds accompany entry/exit countdowns, pressed buttons and other functions. Volume is adjustable for voice announcements, chimes and most sounds.

Alarms are signaled by the Controller's built-in sounder. Alarm volume is **not** adjustable.

Software Update Notifications

Software updates for the Controller are published periodically. Most updates request user permission. Select **Accept**, **Yes** or **OK** to install the update.

Certain critical updates are installed automatically. After updates of this type, information about the update appears on-screen.

The Tools Menu







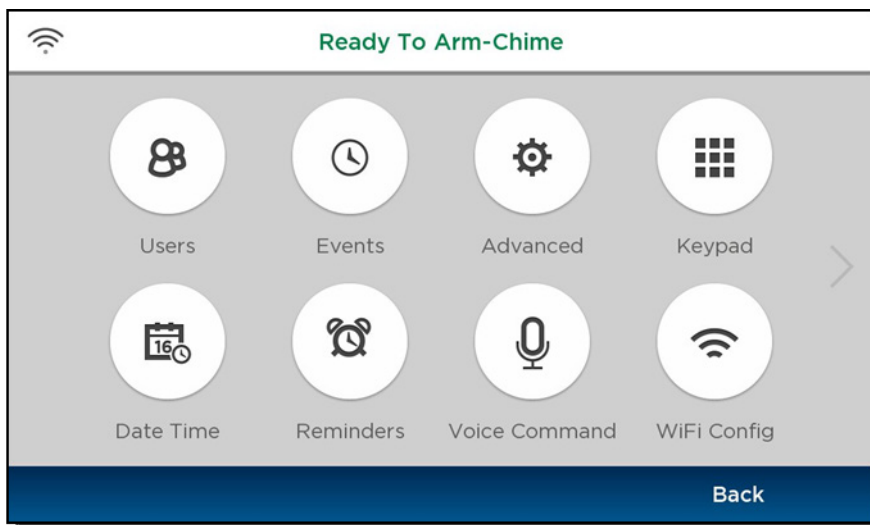

[Home](#) > [Security](#) > [Tools](#)

This menu offers access to most of Lyric's important settings and maintenance functions.

NOTE: The **Master User** code is required to access Tools.



Features available from this screen include:

- | | | |
|---------------|---|---|
| Users |  | Master User can add/remove other users and control users' access to features. See Users and Security Codes . |
| Events |  | View and export system event logs. See Events . |
| Advanced |  | Access to software upgrades, tests and user maintenance functions. Includes features found in Maintenance and System Settings . |
| Keypad |  | Manage mobile devices running keypad apps. See Keypad . |
| Date/Time |  | Set the system's calendar and clock. See Date and Time . |
| Reminders |  | Record and schedule voice memos. See Reminders . |
| Voice Command |  | Use simple phrases to control Smart Scenes or operate Wi-Fi video cameras. See Voice Command . |
| Wi-Fi Config |  | Configure Wi-Fi access points, set security and choose automatic or manual video recovery. See Wi-Fi Configuration . |

Press  on the right side of the screen for more.

Slide Show  View selected photos on the Lyric display. See [Slide Show](#).

Back

Return to the Security menu.

Notices

[Home > Notices](#)

The **Notices** icon alerts you to new information from your security company. Press for more information.

Messages

[Home > Security > Message](#)

Audio messages for all users can be recorded on the Controller.

NOTE: Audio Messages on the Controller are deleted when the system's firmware is updated.

To work with Messages:

1. On the Security menu, select Message. If there are none are saved, the list shows **No items to display**.
2. Press **Add New**. Recording controls appear.
3. Use the **Record, Stop, Play** and **Delete** buttons to record and review your message.
4. Press ↵ to return to the message list.

In the message list, select a message before pressing Play.

The **Delete All** button requires confirmation. Press **Yes** when asked **Are You Sure?**

When messages are stored in the Controller, the Message icon is highlighted.

Reminders

[Home > Security > Tools > Reminders](#)

Reminders can be scheduled to display a text note and optionally, play a brief audio message.

Reminders that are set to require acknowledgment remain on-screen and repeat their audio until dismissed.

NOTES:

- The Master User code is required to access Tools.
- Reminders can only be created when the system is disarmed.
- Reminders on the Controller are deleted when the system's firmware is updated.
- Reminders that don't require acknowledgment will appear on the screen, play any included audio once and clear themselves automatically.

To create a Reminder:

1. On the **Tools** menu, select **Reminders**. If there are none are saved, the list shows **No items to display**.
2. Press **Add New** and **Name**.
3. Use the on-screen keyboard to assign a name and remember to press **Save**.
4. Select **Frequency** and then Once, Daily, Weekly, Weekday or Monthly.
5. If selecting Once, set a Date and Start Time next.
 - If Daily, set a Start Time.
 - If Weekday, set a Start Time.
 - If Weekly, set a Day of the Week and a Start Time.
 - If selecting Monthly, set a Day of the Month and a Start Time.
6. To add an audio message, press **Voice** and select **Yes**. Use the Record, Stop, Play and Delete buttons to record and review the message. When finished recording, press ↵.
7. To require that the Reminder is acknowledged, press **Acknowledge** and select **Yes**.
8. Press **Save**.

To **dismiss** a Reminder that requires acknowledgment, press **OK**.

Security

Home > Security

IMPORTANT

If the Controller is beeping rapidly when you enter the premises, an alarm has occurred and an intruder may still be nearby.

LEAVE IMMEDIATELY and CONTACT THE POLICE from a safe location.

Security Features

- NOTES:**
- For Lyric to report alarms over the internet, your Wi-Fi network MUST have power at all times.
 - You must arm your security system in order for it to sound alarms.

Sensors and Zones	<p>Lyric's sensors are assigned to numbered zones that correspond to areas of your home. For example, the sensor on an entry/exit door might be assigned to Zone 03, a device in a bedroom to Zone 06, and so on.</p> <p>When alarms or trouble conditions occur, the touchscreen displays the zone number and a description of the sensor involved.</p>
Fire Protection	<p>Fire protection is always active when the system is operating normally. An alarm sounds if a fire condition is detected. See Fire/CO Alarm System for important information about fire protection, smoke detectors and planning emergency exit routes.</p>
Carbon Monoxide	<p>Carbon monoxide (CO) detectors, if installed, are always active and sound an alarm if a carbon monoxide condition is detected. See Fire/CO Alarm System for more information.</p>
Burglary Protection	<p>Lyric provides STAY and AWAY burglary protection.</p> <p>STAY mode protects windows and exterior doors, allowing you to move around inside your home without setting off an alarm.</p> <p>AWAY mode protects the entire premises, including interior motion detectors if present.</p> <p>Both modes offer an entry delay period that allows you to reenter the home without setting off an alarm. For long periods such as vacations, the entry delay can be turned off while arming the system.</p> <p>Lyric also allows you to Bypass selected sensors before arming the system.</p> <p>The system also features Chime mode, which can alert you to the opening of protected doors and windows while the system is disarmed.</p>
Security Codes	<p>At the time of installation, the installer asks the homeowner to choose a personal 4-digit security code, known as the "Master User code".</p> <p>Other users can be added, typically with less control over the system than the Master User. See Users and Security Codes.</p> <p>A user code is required when arming or disarming and for some other functions.</p>
Alarms	<p>Alarms are signaled by the controller's internal sounder (and external sirens if used). The screen indicates the zone where the alarm has occurred. After 15 seconds, the sounder stops temporarily and the system begins voice announcements of relevant zone information.</p> <p>After the zones are announced, the panel's sounder resumes sounding. Alarm sounds and voice announcements alternate until the system is disarmed or until alarm bell timeout occurs. If the system is connected to central monitoring, an alarm message is sent.</p> <p>To silence the sounder, disarm the system. The zone(s) causing the alarm remain displayed, indicating <i>Memory Of Alarm</i>. See Clearing a Panic Alarm for more about clearing memory of alarm.</p>
Audio Alarm Verification	<p>Allows your central monitoring station to listen to or talk with individual(s) on the premises (if programmed to do so).</p>

False Alarm Prevention

Many false alarms are caused by minor problems, such as a door left ajar when exiting the home. Lyric includes several features to help prevent false alarms. Note that some are optional or must be programmed by the installer. Disabling these features may increase security, but may also increase the chance of false alarms.

Your installer can help you decide how to use and customize these features. A brief explanation of false alarm prevention features follows, along with advice on what to do if false alarms occur.

Exit/Entry Delays	<p>Programmed delay times allow you to leave after arming the system or disarm it after entering without setting off an alarm. Exceeding a delay period causes an alarm.</p> <p>After a false alarm, disarm the system and contact your monitoring company. They will verify your security code or password, preventing unnecessary calls for emergency response.</p>
Alarm Reporting Delay	<p>Lyric is programmed to wait for a brief period between sounding a burglary alarm on the premises and sending an alarm message to your monitoring company. This delay allows you to disarm the system before an alarm message is sent in error.</p>
Exit Alarms	<p>False alarms can be caused by leaving the house and forgetting to close the door. If this happens, Lyric sounds an alarm and displays an Exit Error.</p> <p>The alarm reporting delay gives you time to disarm the system before an alarm message is sent.</p>
Exit Time Restart	<p>If you leave the premises and enter again before the exit delay has expired, the exit delay restarts, giving you more time to leave without causing an alarm.</p> <p>With 10 seconds left to exit, the Controller begins beeping quickly, indicating that an alarm will occur if you don't exit or disarm the system immediately.</p>
Exit Delay Restart/Reset	<p>If this occurs, disarm the system and arm it again when you are ready to leave. You can restart the Exit Delay by pressing Restart Timer.</p>
Silent Exit	<p>Press Silent Exit to mute the beeping sound that accompanies exit countdowns in most situations. Voice confirmation of arming status is not muted. Silent Exit doubles the Exit Delay time.</p>
Quick Exit	<p>If the system has been armed and someone needs to leave the premises, you can press this button, which restarts exit delay, allowing exit from the premises without the need to disarm and re-arm.</p>
Entry Delay	<p>If the system is armed, this is the period allowed between a door opening and the system being disarmed with a user code. Failure to disarm the system during the Entry Delay causes an alarm. <i>Delay period set by your installer.</i></p>
Exit Delay	<p>Period that begins upon arming the system, during which household members can exit through entry/exit doors without triggering an alarm. <i>Delay period set by your installer.</i></p>

Arming the System





The Home button beneath the screen lights green when the system is ready to be armed. If the button is blinking green, the system is not ready to arm.

Before arming your system, all protected doors, windows, and other protection zones should be closed or bypassed (see [Bypassing Protection Zones](#)).

To change the volume of countdown sounds and security status voice announcements, see [System Settings](#).

NOTE: When a security code is required, a valid code must be entered within 10 seconds of pressing an Arm button. If an invalid code is entered, or more than 10 seconds elapses, the Security menu returns and the system is not armed.

Arming states include

Arm Away		For times when no one is home; protects all perimeter and interior zones.
Arm Stay		For times when the house is occupied; protects only perimeter zones.
Arm Custom		Arms the system with pre-selected zones bypassed.
Bypass		This feature allows you to arm the system while intentionally leaving selected zones unprotected.
Arm Night		For times when the house is occupied; protects perimeter zones and interior motion sensors if used. Other interior zones are unprotected. <i>Enabled by your installer and only used with interior motion sensors.</i>
Instant		For times when Entry/Exit doors are not expected to open at all . Entry Delay is eliminated. When the system is armed, an alarm occurs immediately if an exterior door is opened.
Quick Arm		Press to arm the system in any mode without entering a user code, <i>if programmed</i> . NOTE: A user code is always needed to disarm the system.
Auto Stay		If you arm the system in the “AWAY” mode but no one exits, the alarm system automatically changes to the “STAY” mode. This helps to prevent unwanted alarms when someone remains on the premises. Disarm the system and Arm Away again when you are ready to leave. <i>Enabled by your installer.</i>

Arm Away

[Security > Arm Away](#)

By default, this mode’s exit delay countdown is accompanied by a beeping sound.

1. Enter a user code or press **Quick Arm**. (If desired, click **Silent Exit** first.)
2. The system beeps twice and announces “Armed Away; exit now”. The exit delay countdown begins.
Press **Restart Timer** if you need more time to leave.
3. Leave the premises and close the door before the countdown ends.
4. The system arms in Away mode. (Door and window sensors and interior motion sensors are active.)

Arm Stay

Security > Arm Stay

By default, this mode's exit delay countdown is silent.

1. Enter a user code or press **Quick Arm**.
2. The system beeps three times and announces "Armed Stay; exit now". The exit delay countdown begins.
Press **Restart Timer** if you need more time to leave.
3. The system arms in Stay mode. Door and window sensors are active, but interior motion sensors are not active.

Arm Custom

Security > Arm Custom

Use this option to pre-set zones for bypass when arming the system. You can also enable or disable the entry delay.

1. Select Arm Custom to display a list of zones.
2. Select the zones you wish to bypass when arming the system.
3. Select Arm Custom on the zone list screen.
4. A numerical keypad appears.
Select **Entry Delay** if desired. (See [Instant Mode](#) for more about disabling Entry Delay.)
5. Arm the system by entering a user code.
6. The exit delay countdown begins.
7. Leave the premises and close the door the same way you would when setting Away mode.

Bypassed zones are left unprotected.

NOTE that the next time Arm Custom is used, the **same zones that were previously selected** are highlighted on the zone list screen. If desired, select different zones for custom arming.

Instant Mode

Security > Arm Custom

In Instant mode, an alarm occurs immediately when a protected Entry/Exit is opened. There is no delay during which a code can be entered to disarm the system.

1. Select Arm Custom to display the zone list screen.
2. If any zones have been previously set for bypass, deselect them.
3. Press **Arm Custom**.
4. When the keypad appears, **de-select Entry Delay**.
5. Enter a user code to arm the system and leave the premises during the exit delay countdown.

Arm Night

Security > Arm Stay

Arm Night must be enabled by your security professional.

1. Select Arm Stay to display the keypad.
2. Select Arm Night and then enter a user code.
3. The system beeps and announces "Armed Night Stay; exit now". The exit delay countdown begins.
Press **Restart Timer** if you need more time to leave.
4. The system arms in **Arm Night** mode. Doors and windows and pre-selected zones are active.

Disarming the System

Security > Disarm

NOTE: Disarming the system also silences audible alarms and trouble alerts.

IMPORTANT SECURITY NOTICE

Your wireless key (key fob) is similar to your keys or access card. If lost or stolen, another person can compromise your security system. Immediately notify your Dealer/Installer of a lost or stolen wireless key. The Dealer/Installer will then remove the wireless key programming from the security system.

To disarm your security system:

1. Select **Disarm**. A keypad appears.
2. Enter a user code. The system beeps and announces “Disarmed”, followed by alerts about system readiness, if any. The announcement “Check system” indicates a faulted sensor or problems in the Controller itself.

In most situations, if a valid user code is not entered within 30 seconds of pressing **Disarm**, the Home screen reappears, and the system remains armed.

- NOTES:**
- If a valid code is not entered by the time the entry delay ends, an alarm occurs.
 - The Guest code and the Installer code can only disarm the system if that code was used to arm the system. If the Quick Arm option has been used, neither the Guest Code nor Installer Code can disarm the system.

Bypassing Protection Zones

Bypass allows arming the system while intentionally leaving selected zones unprotected.

Bypassed zones will not trigger an alarm.

- NOTES:**
- Fire and Carbon Monoxide (CO) and Panic zones cannot be bypassed.
 - Bypassed zones are automatically unbypassed when the system is disarmed.

To Bypass zones:

1. Before arming the system, press **Zones** on the Security menu. A list of your system’s zones appears. Faulted (open) zones are shown in red or orange.
Use the up and down arrows to scroll through the list of zones.
2. Select the zone(s) to be bypassed.
3. Press **Bypass** at the bottom of the screen. A keypad appears.
At the bottom of the screen, you can **Bypass All Faulted**, which selects all zones with faults or other issues.
Press **Select All** to toggle through options for selecting zones.
4. Enter a user code. The zone list reappears, with the Bypass icon shown for the affected zones.
5. Arm the system as usual.

Press **Clear Bypass** to un-bypass any previously bypassed zones. Any zones with faults must be addressed before arming the system.

Entry and Exit Delays

NOTE: Entry and exit delay times are programmed by your installer. There is room to jot them down in [Your System Information](#), near the end of this guide.

Entry Delay

Entry delay allows time to disarm the system when entering the premises. If the system is not disarmed before the entry delay period ends, an alarm occurs. If programmed, the Controller beeps during the entry delay period as a reminder to disarm the system.

Two different entry delay periods can be programmed. The first is for the primary entrance, typically, the front door. The second can be used for a secondary entrance, where more time might be needed to walk to the Controller to disarm the system.

Exit Delay

Exit delay begins immediately after the system is armed, providing time to leave through the designated exit door without causing an alarm. In most situations, the touchscreen displays a countdown of the remaining time. The exit door must be closed before the end of the exit delay.

Typically, the system beeps slowly when counting down to Arm Away; during the last 10 seconds of the delay period, the beeping speeds up. The exit beeps cannot be silenced unless **Silent Exit** is selected.

Restart Exit Delay

The **Restart Timer** button appears only if the option has been programmed by the installer. Exit delay can be restarted **once**.

Exit Alarm

This option helps minimize false alarms sent to the monitoring company. Exit Alarm must be enabled by your installer.

Exit delay begins whenever the system is armed.

- If an exterior door or protected interior zone is faulted during the exit delay (and remains faulted when the exit delay ends), an exit alarm occurs and an **entry delay** countdown begins.
- If the system is disarmed before the entry delay ends, the alarm sound stops and the message **Alarm Cancelled** and any faulted zones appear.
- **No message is sent to the monitoring company.** Any open zones must be secured before the exit alarm condition can be cleared.

To clear the display, press **Disarm** and enter a security code.

- If the system is not disarmed before the entry delay ends, and an entry/exit door or interior zone is still open, the alarm sound continues and an **Exit Alarm** message is sent to the alarm monitoring company, along with a "Recent Close" message (if the Recent Close option is enabled).
- The message **Alarm Exit Error** appears. Faulted zones are also displayed. The alarm will continue to sound until the system is disarmed or timeout occurs.

To stop the alarm, disarm the system. The message **Alarm Cancelled** will be displayed. "**Alarm**" and faulted zones continue to be displayed.

To clear the display, press Disarm and re-enter the security code.

An exit alarm ("Alarm - Entry Exit") also occurs if an entry/exit door or interior zone is faulted within two minutes after the end of the exit delay.

Panic Alarms

Available Panic modes may vary, depending on the options programmed by your installer.

IMPORTANT

Please note the difference between the Panic  button below the touchscreen and the different Panic icons on the touchscreen.





Activating a Panic Alarm

1. Press and hold the  button on the Controller until Panic icons appear on the screen.
2. Press the appropriate Panic icon on the screen.

Depending on the Panic mode selected, an alarm tone sounds and the appropriate alarm icon appears on the touchscreen.

Pressing **Police** typically sends a **silent** message to your monitoring company; verify this setting with your installer. When you take your finger away from the Police icon, the screen **appears to return to a normal state**, with the  button on the Controller blinking. However, the alarm message has been sent.

Common Panic Icons

	Fire	Alerts the monitoring company that a fire condition exists. (Displays zone 995)
	Police	Alerts the monitoring company that a police emergency exists. (Displays zone 999, default is silent)
	Medical	If programmed, alerts the monitoring company to other types of emergency. (Displays zone 996)
	Local	Activates sirens and sounders on premises without alerting the monitoring company. (Displays zone 998)

Types of Panic Alarms

Silent emergency (silent alarm)	Sends an alarm signal to the monitoring company, but triggers no audible alarms or touchscreen display. Requires connection to a monitoring company.
Audible emergency (audible alarm)	Sends an emergency message to the monitoring company, if connected. A loud, steady tone sounds at the Controller and external sounders if connected, and an alarm appears on the touchscreen.
Personal emergency or Aux alarm	Sends an emergency message to the monitoring company if connected and sounds at the Controller, but not at external sounders. An alarm icon appears.
Fire alarm	Sends a fire alarm message to the monitoring company if connected. A unique tone sounds at the Controller and external sounders are activated if connected. A Fire alarm icon appears.
Local alarm	If programmed, activates the sirens and sounders on the premises without sending a message to the monitoring company.

Cancelling a Panic Alarm

Depending on the **type** of panic alarm in effect, a keypad may appear immediately after the alarm is initiated.

1. Enter a user code to cancel the alarm.
2. The audible alarms stop and **Alarm Cancel** appears.

If a silent alarm has been activated and the Home screen is displayed:

1. Select Security on the Home screen. Typically, a Disarm icon appears; a Security status message such as “Not Ready To Arm” may be displayed.
2. Press **Disarm**. A keypad appears on the touchscreen.
3. Enter a user code.
4. The normal Security menu returns and the  button on the Controller stops blinking.

Clearing a Panic Alarm

After a panic alarm is cancelled, the Controller continues to display zone information associated with the alarm (this feature is known as **Memory of Alarm**).

To cancel and silence the alarm, enter a user code.

To clear memory of alarm on the screen:

1. Press the Home button beneath the screen.
2. Re-enter the user code.

Memory of alarm can also be dismissed with these steps:

1. Cancel and silence the alarm with a user code as above.
2. Select **Zones** on the Security menu. The zone number associated with the type of alarm appears.
3. Press **Clear Alarms** at the bottom of the screen.
4. Enter a user code. The Zones screen displays “No items to display!”
5. Press ↵ to return to the Security menu or press the Home button.

Chimes/Voice Annunciations

IMPORTANT

The Chime feature is intended for convenience and is not intended for life safety purposes or pool alarm and does not meet the requirements of UL 2017.

Volume/Mute

[Home > Settings](#)

- NOTES:**
- Chime and voice volume/muting can only be changed when the system is disarmed.
 - Voice annunciations are controlled by enabling or disabling Chimes.
 - Voice annunciations should not be confused with Lyric’s Automation: Voice Command or Two-Way Voice (Audio Alarm Verification) features.

Lyric can give audible notifications when a protected zone opens **while the system is disarmed**. With Chimes enabled three beeps (or a selectable tone) sound at the Controller when a protected zone is opened. If programmed, a voice announcement also sounds.

1. On the Home screen, select **Settings**.
2. Select **Chime** to enable chime sounds and voice annunciations. To mute all, de-select. For chime sounds only, de-select Voice.
3. Adjust volume with the slider.
4. Press **Save**.

Setting Chime Sounds

[Home > Security > Zones](#)

- NOTES:**
- Chime sounds can only be changed when the system is disarmed.
 - Sounds can be changed only for door, window and motion sensors. Sounds associated with smoke and CO detectors cannot be changed.

Different sounds can be assigned to the sensors in your system.

1. On the Zones menu, press **Select All** repeatedly to choose **Select Chime**. A list of sensors appears.
2. Select a sensor. The Controller displays available sounds.
3. Press repeatedly to choose a sound. (Options include **Disabled**.)
4. Press ↵ to save your selection and return to the Security menu.

Audio Alarm Verification (Two-Way Voice)

This feature allows your central monitoring station to listen to or talk with individual(s) on the premises when an alarm has occurred (if programmed).

- NOTES:**
- System announcements are disabled when this feature is active.
 - Fire and CO alarms will prevent Audio Alarm Verification from operating.
 - New Fire or CO alarms will terminate Audio Alarm Verification operation.
 - Burglar alarms occurring during Audio Alarm Verification operation do not interrupt operation and are reported immediately after operation concludes.
 - Audio Alarm Verification modes are controlled by the central station.

Built-In Camera

Lyric's built-in camera takes a snapshot of the person at the Controller when the system is manually disarmed. Snapshots can be viewed via your remote services.

Built-in camera options vary with the services to which you have subscribed. Ask your installer for more information.

Automation: Z-Wave and Other Devices

[Home](#) > [Automation](#)

IMPORTANT

Automation can ONLY be used for lifestyle enhancement. It must not be used for personal safety or property protection.

Working with Z-Wave Devices

NOTE Z-Wave automation functionality is supplementary only and has not been evaluated by compliance agency.

Z-Wave technology is designed to automate devices in a home control network. The Lyric Controller is a security enabled Z-Wave device that supports Z-Wave Network Wide Inclusion (NWI) Mode.

The Controller and Z-Wave devices added to your system are linked together in a wireless network. Each device in the network is assigned a unique address and cannot be activated by a neighbor's Z-Wave controller. The Z-Wave network supports multiple controllers, allowing Z-Wave remote controls to be used throughout the home.

NOTE: In some cases, a Z-Wave device might not report its status to the Lyric Controller when an action is initiated at the device itself. This varies with the manufacturer.

Press **Automation** on the Home screen. The Automation Management screen appears, initially displaying categories of Z-Wave devices. (*Your Controller's display may differ from these illustrations.*)

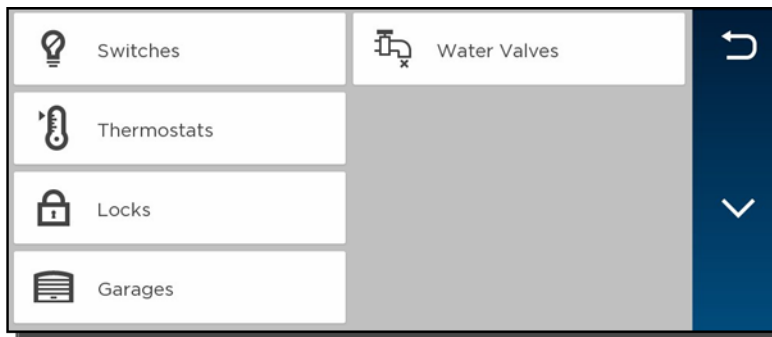

This screen may also display “Press to see Failed Devices”. See [Failed Devices \(Failed Nodes\)](#) for more information.

Press the Down arrow for more options:



Consult your installer about the options available in your system.

Selecting a device category opens a list of devices in that category. An example of the **Switch** category is pictured.

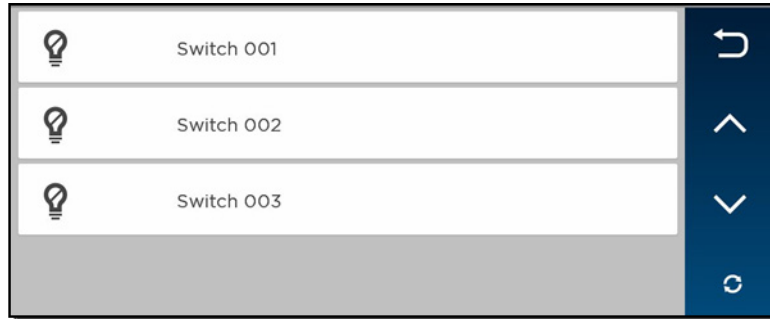

For most devices, status is indicated by the color of the icon.

The **Refresh**  button updates device status indications on the display.

Operating Z-Wave Devices Manually

1. On the Automation Management screen, select one of the device categories.
2. Select the device you wish to operate. Controls appear.
3. Lighting controls might offer an On/Off button or a slide control for dimmers.
4. Thermostats may display temperature set points and energy-saving features. The options shown will vary with your device.
5. Operate the device as desired.
6. Press  to return to the previous screen.

Adding Z-Wave Devices (Include)

NOTE: When adding a device, it may be necessary to perform the **Exclude** procedure before the device can be Included successfully.

1. On the Automation Management screen, press the Down arrow.
2. Press **Tools**.
3. On-screen options appear, including **Include Devices**, **Exclude Devices** and **Advanced Tools**. (**View Failed Devices** may also appear.)
4. Select **Include Devices**.
The panel enters Inclusion mode. Next, the panel displays “Ready to Include device. Press the function button on device”.
5. Press the device’s Function button within 60 seconds. (Note that the location of the Function button varies with the device you are adding. See the device’s instructions.)
The panel displays “Device Found. Please Wait”.
6. To include additional devices, repeat step 5.
OR
Press **Abort** to complete the Inclusion process.
7. Press  to return to the previous screen.

Including Light Switches or Outlet Modules

Install the receptacle, wall switch or lamp/appliance module **before** Including it in your system. Refer to the device’s instructions for more information about installation.

Z-Wave switches and outlet modules may vary. Refer to the device’s instructions to ensure that it is Included properly in your system.

Including Door Locks

IMPORTANT

For security, Z-Wave door locks are encrypted, and enroll at low power transmission range (approximately 6 feet). This requires Including the lock before its installation in a door.

Assemble the lock, connect necessary cables and install batteries according to the device's instructions. **Be sure the door lock's orientation/handedness is correct.**

Z-Wave door locks vary. Refer to the device's instructions to ensure that it is Included properly and to program a user code.

After Inclusion, install the lock within recommended Z-Wave range (see [Wireless Range](#) for more information).

- NOTES:**
- Program the 4-digit user code into the Controller. When programming user codes into the Controller, determine if the user will have access to the Z-Wave lock. If so, the user code will be transferred to the lock.
 - If using a lock with Smart Scenes, automatic locking/re-locking features should be disabled.
 - Due to Low Power Inclusion Mode of secure devices, Include the Z-Wave Lock first, if not using an Inclusion Tool/Remote Control. The lock should be installed before including other devices.
 - During operation, the system will display "JAMMED" and will revert to "Unlocked" status if a jammed lock is detected.
 - When performing a command directly from a thermostat or water shutoff valve, a change of status message may not appear at the Controller.

Including Thermostats

Install and **test** the thermostat before Including it in your system. Refer to the device's instructions for more information about installation.

IMPORTANT

Honeywell is not responsible for property damages due to improper setting of thermostat modes.

- NOTES:**
- Some thermostats do not update temperature status automatically.
 - When using Z-Wave thermostat control on the Controller, the thermostat's scheduling feature should not be used.
 - When the HOLD button on the Controller's thermostat control screen is highlighted, Z-Wave scenes driven by Smart Scenes will not affect thermostat operation. Additionally, if your system is connected to remote services, the remote 7-day schedules will also not affect thermostat operation.
 - For threshold monitoring to be configurable on the remote services and Z-Wave thermostat screens, the respective zones will first need to be assigned with a response type in zone programming. Threshold monitoring is not available on all thermostats.
 - Both Zones for each respective thermostat must be programmed (for example, Zone 180 & 181 for thermostat #1, Zone 182 & 183 for thermostat #2 and Zone 184 & 185 for thermostat #3).
 - When temperature is represented in Celsius, Lyric matches the temperature increment of the particular thermostat for Heat, Emergency Heat and Cool set points. Increments can be one degree or half degree, depending on the thermostat.
 - If Celsius scale is used in the thermostat, the Controller must also be set to Celsius scale.
 - If the Energy Saving mode is set, the Controller displays Energy Saving Heat/Cooling Setpoint Temperatures that are programmed at the thermostat.
 - An additional "Energy Saving" function in the thermostat is used to set/unset the Energy Saving mode.

Lyric Controller Z-Wave Thermostat Functions



Button	Function
Mode	Select between HEAT, COOL and OFF.
Fan	Select between ON, CIRCULATE and AUTO.
HOLD	Allows temporary override of programmed Smart Scenes that may operate the thermostat.
NORMAL	Allows selected thermostat to run programmed Smart Scenes.
NO SCHED	Prevents Smart Scenes from operating the selected thermostat
Threshold Monitoring	Enable/Disable Threshold Monitoring Feature (if available)
Saving Off-Saving On	Enables/disables the thermostat's Energy Saving Schedule Function.
EDIT	Used to edit Thermostat name.
BACK	Used to return to Thermostats screen.

Thermostat Energy Saving Mode

1.	On the Automation Management screen, select Thermostats .
2.	Select the desired thermostat from the displayed list.
3.	On the thermostat control screen, press the "Saving Off" button OR "Saving On" to activate or deactivate the thermostat's Energy Saving Schedule Function when a heating or cooling operation is selected.

Deleting Z-Wave Devices (Exclude)

To delete (Exclude) a Z-Wave device:

1. On the Automation Management screen, press the  arrow.
 2. Press **Tools**.
 3. Select **Exclude Devices**.
 4. The panel enters Exclusion mode. Next, the panel displays "Ready to Exclude device. Press the function button on device."
 5. Press the device's Function button.
 6. The device is excluded from the system and its information is displayed.
 7. To delete another device, press **Exclude** on the right side of the screen.
- OR
8. Press  to return to the previous screen(s).

Editing Z-Wave Device Names

1. On the Automation Management screen, select the category that includes the device you want to rename.
2. Select the device in the displayed list.
3. The device's controls appear, showing the device's default name.
4. Press **Edit** on the right side of the screen.
5. A keyboard appears on the touchscreen.
6. Press **Clear** to delete the default name.
7. Enter a custom name, using as many as 14 characters.
8. **Save** the device's new name.
9. When you are finished editing, press  to return to the previous screen(s).

Advanced Tools

1. From the Automation Management screen, open **Tools**.
2. Select **Advanced Tools**.
3. Enter the Master User code. The Advanced Tools screen appears:

View Enrolled Devices	View Enrolled Controllers
Reset Controller	Pri. Controller Shift to Secondary
Locking Door	Learn
All Devices Off	All Devices On

View Enrolled Devices

Press to display Z-Wave device information: System Index/name, Secured or Non-Secured, device type, device ID, manufacturer, node number.

View Enrolled Controllers

Press to display controller information: Primary or Secondary, Z-Wave Library Rev., Home ID, device type, device ID, node number, manufacturer, Secured or Non-Secured.

Reset Controller

Press to delete all Z-Wave nodes in the Controller, and reset the Controller's Home ID. When prompted, press **Yes** to confirm.

Note that resetting the Controller does **not** delete/Exclude individual Z-Wave devices. Therefore, each device must be Excluded before being added/Included in the Controller again.

Pri. Controller Shift to Secondary

Press to designate another controller (such as a Z-Wave remote control) as the Primary Controller.

When the panel displays "Shifting", start the "Learn" function on the secondary controller. *Refer to the secondary controller's instructions for more information.*

NOTE: Both controllers can operate the system's Z-Wave devices, but only the Primary can Include/Exclude devices.

Locking Door

Press to have your system **arm** automatically when a Z-Wave door lock is locked. Press repeatedly to select **Away** mode, **Stay** mode, **Arm without Auto-Stay** mode or to **Disable** this option.

Learn

This function is usually performed on a control panel or Z-Wave remote control being added to the system as a secondary controller OR on a secondary controller being designated as Primary.

Press after starting the Include or Shift Control function on the primary controller.

All Devices Off

Press to manually turn off all Z-Wave devices. **Note** that some thermostats will enter Setback mode.

All Devices On

Press to manually turn on all Z-Wave devices. **NOTE:** Some thermostats will exit Setback mode.

Failed Devices (Failed Nodes)

When the system tries to operate a Z-Wave device that has no AC power or other problems, it is identified as a **Failed Device**. The system may take up to a minute after the operation to detect the failure.

To view Failed Devices:



1. On the Automation Management screen, select **View Failed Devices**.
The panel displays “**Failed Nodes Found!**”
2. Press **OK**.
3. The device’s information is displayed. If multiple devices are listed, use the up and down arrows at right to view the entire list.

NOTE: When troubleshooting, first make sure that power has been restored.

If a device is defective or otherwise unavailable, use the **Fix All** option.

1. Select **Fix All** on the right side of the screen. The system displays “**This will delete all failed nodes.**”
2. Press **Yes** to confirm.

Devices deleted with **Fix All** must be added to the system again. See [Adding Z-Wave Devices \(Include\)](#).

Failed Z-Wave devices are also indicated by a  symbol on the Automation Management screen or the  symbol appearing in gray on the Home screen.

Important Notes About Z-Wave Devices

WARNING: NOT FOR USE WITH MEDICAL OR LIFE SUPPORT EQUIPMENT!

Z-Wave enabled devices should never be used to supply power to, or control the On/Off status of medical and/or life support equipment.

Wireless Range

This device complies with the Z-Wave[®] standard of open-air, line of sight transmission distances of 100 feet. Actual performance in a home depends on the number of walls between the controller and the destination device, the type of construction and the number of Z-Wave enabled devices installed in the control network.

Note that Z-Wave home control networks are designed to work properly alongside wireless security sensors, Wi-Fi, Bluetooth and other wireless devices. Some 900MHz wireless devices such as baby cams, wireless video devices and older cordless phones may cause interference and limit Z-Wave functionality.

Things to consider regarding RF range:

- Each wall or obstacle (refrigerators, large TVs, etc.) between the remote and the destination device can reduce the maximum range of 100 feet by approximately 25-30%.
- Brick, tile or concrete walls block more of the RF signal than walls made of wooden studs and drywall.
- Wall mounted Z-Wave devices installed in metal junction boxes will suffer a significant loss of range (approximately 20%) since the metal box blocks a large part of the RF signal.

Additional Z-Wave Information

- Lyric can control up to **72** Z-Wave devices.
- The system supports a maximum of 232 nodes. Note that a node is created every time a device is Included, even if the device is being re-added to the system after being Excluded. This can cause the number of nodes in the system to exceed the number of actual devices.
- If the limit of 232 nodes is met and you need to add or re-Include more Z-Wave devices, use the Reset Controller function. Be aware that resetting the controller deletes all of the system’s nodes, requiring all devices to be Included again. Node numbers can be viewed by selecting Automation > Tools > Advanced Tools > View Enrolled Devices. Remember that the system may require the Master User code for access to Advanced Tools.

- The system is not aware of door locks being enabled with any temporary user shutdown feature such as Vacation Mode. The system will continue to unlock a door if programmed to do so via Smart Scenes.
- Z-Wave door locks with thumbturns: Certain models allow a brief period in which the thumbturn can be operated manually before the device locks automatically. Locks of this type are not recommended for use with Smart Scenes.

Z-Wave Compatibility

Z-Wave devices vary; follow the instructions provided with the specific device when including and excluding devices into your Z-Wave network.

NOTE: Not all Z-Wave devices have been tested. Some functions may produce unpredictable results.

Door Locks	Appliance
Yale® Real Living Push-Button Lever Lock	HomeManageables Appliance Module
Yale Real Living Touchscreen Lever Lock	Wayne Dalton Small Appliance Module
Yale Real Living Push-Button Deadbolt Lock	GE® Wireless Lighting Control Plug-In Appliance Module
Yale Real Living Touchscreen Deadbolt Lock	Cooper In-Wall Duplex Receptacle Module (Model RF9505-TDS)
Schlage® Link Deadbolt Lock	Lights
Schlage Link Lever Lock	Leviton®/ViziaRF+® Switches
Kwikset® Smartcode Lever lock	Leviton/ViziaRF+ Dimmers
Kwikset Smartcode Deadbolt Lock	Leviton/ViziaRF+ Plug-In Appliance Modules
Thermostats	GE Wireless Lighting Control Dimmers
Honeywell Z-Wave Thermostat (ZWSTAT)	GE Wireless Lighting Control Switches
Wayne Dalton Z-Wave Thermostat	GE Wireless Lighting Control Plug-In Appliance Modules
Trane® Z-Wave Thermostat	Intermatic In-Wall Receptacle (Model HA01)
Residential Control Systems Thermostat (Model TZ45)	Cooper Plug-in Lighting Switch Module (Model RFAPM)
Intermatic InTouch Thermostat (Model CA8900)	AEON Labs Lamp/Dimmer Module (Model DSC06106-ZWUS)
Radio Thermostat Company of America (Model CT30, CT32, CT100, CT101 and CT110)	Remotec Lamp Dimmer Module (Model ZDS-100US)
Siren	Window Shades
FortrezZ SSA1/SSA2 Wireless Siren & Strobe Alarm	Somfy® ILT Series
Water Valve	
FortrezZ WV-01 Wireless Z-Wave Water Valve	

EXISTING NETWORK NOTE: Z-Wave products from other manufacturers can be included (added) into the Lyric network. Z-Wave devices that are always powered can serve as repeaters regardless of manufacturer.

USE OF THESE PRODUCTS IN COMBINATION WITH NON-HONEYWELL PRODUCTS IN A WIRELESS MESH NETWORK, OR TO ACCESS, MONITOR OR CONTROL DEVICES IN A WIRELESS MESH NETWORK VIA THE INTERNET OR ANOTHER EXTERNAL WIDE AREA NETWORK, MAY REQUIRE A SEPARATE LICENSE FROM SIPCO, LLC. FOR MORE INFORMATION, CONTACT SIPCO, LLC OR IPCO, LLC AT 8215 ROSWELL RD., BUILDING 900, SUITE 950, ATLANTA, GA 303350, OR AT WWW.SIPCOLLC.COM OR WWW.INTUSIQ.COM

Garage Doors

Home > Automation > Garages

Garage door operation from the Controller requires installation of a garage door control kit. Consult your security professional for more information.

The Lyric Controller can remotely operate and monitor as many as four garage doors. The system can be armed when the garage door is opened. After it is closed, the zone will be monitored without providing burglary protection.

The Controller can automatically close garage doors if left open for more than a given time period (**Close in**) or at a specified time (**Close at**). Garage doors can also be programmed for monitoring only.

IMPORTANT

Do not use Lyric's garage door automation with any garage door opener that lacks the safety features required by U.S. federal safety standards (this includes any garage door opener model manufactured before January 1, 1993). A garage door opener that cannot detect an object and stop and reverse the door does not meet current U.S. federal safety standards. Your garage door opener also must signal before unattended door operation. For more information please consult your garage door opener manual.

NOTE: Press **Switches** on the Automation Management menu to configure new Z-Wave binary garage door openers. Ask your security professional for more information.

Garage Door Operation from the Lyric Controller

1. On the Home screen, select **Automation**.
2. On the Automation Management menu, press **Garages**. The Controller displays the Open/Closed status of your connected garage doors.
3. Select the garage door you wish to operate.
4. Press the button in the middle of the screen to open or close the garage door.

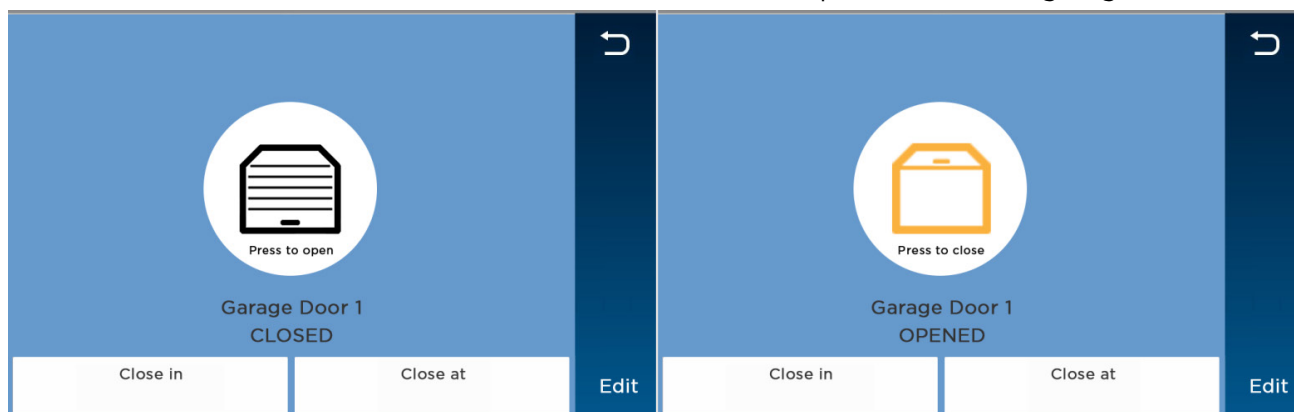

Close in	Use the keypad to set a specific time to wait before an open garage door closes automatically (maximum 12 hours and 59 minutes). Use leading zeroes when entering a number of hours less than 10 ("09:15" or "00:45"). Press Done to save.
Close at	Use the keypad to set a specific time of day that an open garage door closes automatically. Remember to specify AM or PM. Press Done to save.
Edit	Press to rename the selected garage door. Use the on-screen keypad and press Save .

NOTE: The Lyric Controller does not support the status LED on the garage kit's relay module (Honeywell 5877).

Automation: Smart Scenes

Home > Smart Scenes

Smart Scenes are used to automate Lyric functions for comfort, energy savings and security. Multiple settings can be put into effect with a single command. For example, selected lights can respond to a door opening or movement in the middle of the night. Climate settings can be controlled by your schedule and the security system can disarm automatically for expected visitors or babysitters. Selected functions can be restricted to the homeowner, and limited access given to children or guests.

IMPORTANT

When the Controller is connected to a remote services account (e.g. Honeywell Total Connect™), Smart Scenes can be created and modified ONLY via remote services.

Smart Scenes can be created, deleted or edited at the Controller ONLY by the Master User. See [Smart Scenes and User Access](#) for more about **types** of users and their access to different functions.

Three types of Smart Scene can automate combinations of security and lifestyle settings:

- **Anytime:** Initiated by users.
- **Triggered:** Initiated by the system in response to user-defined conditions.
- **Scheduled:** Initiated by the system's calendar and clock.

Smart Scenes are frequently used in pairs. For example, a Smart Scene might be set to operate multiple devices, turning on lights and opening blinds or shades. A second Smart Scene could be used to return these devices to their Off or closed states.

- NOTES:**
- As many as 100 Smart Scenes can be created at the Lyric Controller or via remote services.
 - You can modify (Edit), manually start (Run) and review (Show) Smart Scenes prior to operation.
 - Scheduled and Triggered Smart Scenes can be paused with the Hold function.
 - Setup details vary with each type of Smart Scene.
 - Many buttons in Smart Scenes toggle through different options when pressed repeatedly.
 - The system treats security actions such as Arm Away, Arm Stay or Disarm separately from changes to lifestyle devices such as lights, locks and thermostats.
 - Options that offer operations with both will display them in separate categories called Security and Devices.

Smart Scenes and User Access

- NOTES:**
- The Master User designates which types of user have access to each Smart Scene. See [Users and Security Codes](#) for more information on different types of users.
 - Smart Scenes can be created, deleted or edited ONLY by the Master User.
 - The **Add New** button is available only to the Master User.

Regular users can Run and Show Smart Scenes created for Regular Users and Guests as well as those designated "All Users". Guests can Run and Show Smart Scenes created for Guests as well as those designated "All Users".

To work with Smart Scenes:

1. Select **Smart Scenes** on the Home screen. A keypad appears.
2. Enter a user code to display the Smart Scenes menu. From here, Smart Scenes can be created or viewed by type.



Creating a Smart Scene

Creating any Smart Scene involves these settings:

- Name
- The type of trigger that initiates the Smart Scene
- The type of user who can manually run the Smart Scene
- The resulting action(s) that take place when the triggering events or conditions occur

NOTE: Creating a Smart Scene should begin with giving it a **Name**.

1. Select **Add New**. (The default name that appears may differ from the illustration.)

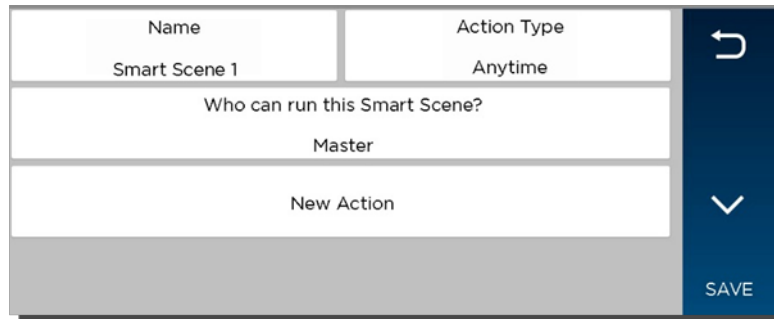

2. Press **Name**.
3. Use the onscreen keyboard to enter a name and **Save** it.
4. Select the type of user who can run the Smart Scene. Choices include:
 - Master
 - Regular Users
 - Guest
5. Press **Action Type** to toggle through the types of Smart Scene.
 - a. **Anytime:** Go to Step #6.
 - b. **Scheduled:** Go to Step #7.
 - c. **Triggered:** Go to Step #8.
6. Select **Anytime**. These options appear:
 - Name
 - Action Type
 - Who can run this Smart Scene? (User type)
 - New Action
 - a. Press **New Action** to define the system's response when the Smart Scene is triggered.
 - b. When settings are complete, press ↶ until the Smart Scene appears with its name displayed.
 - c. Press **Save**. Press ↶ to return to the main Smart Scenes menu.

7. Select **Scheduled**.

- a. Select the type of user who can run the Smart Scene.
- b. Select **Scheduled** to display clock and calendar settings.
- c. Set a time when the Smart Scene will start. Be sure to specify AM or PM.

You can select **Sunrise** or **Sunset** instead of setting a time on the clock. Selecting Sunrise or Sunset overrides the clock controls.

NOTE that updated Sunrise and Sunset times may depend on the system's connection to the internet or cellular phone network. Ask your installer for more information.

- d. Set the days of the week for the Smart Scene to take place.
- e. Press **Save**. The schedule settings are displayed.
- f. Press **New Action** to define the response when the scheduled time occurs (see Step #8).
- g. Press ↵ to return to the Smart Scenes menu.

8. Select **Triggered Action**. These options appear:

Name	Action Type Triggered	
User		
Event Zone Type	Restore Zone Type	
Trigger	Zone <i>or</i> Device	
System Operation	New Action	

Smart Scenes can be started by one or a combination of the following options:

- Event Zone Type
- Restore Zone Type
- Trigger
- System Operation

NOTE: **Event Zone Type**, **Restore Zone Type** and **Trigger** can be different kinds of conditions.

For example, a given Smart Scene can be triggered by a Fire alarm OR by an Entry/Exit event. Smart Scenes can also be triggered by Trouble conditions (Trouble as the Trigger in one of the system's zones).

Device-related events (such as Light On, Light Off, Door Locked, Door Unlocked) set the button at right to **Device**. Choices depend on the devices installed in your system.

- a. **Event Zone Type** starts the Smart Scene in response to any event (Fault, Trouble or Alarm) in any protected Zone of a specific zone type. Select the desired option. Typical zone types include:
 - Entry/Exit (front and back doors)
 - Perimeter (typically window sensors)
 - Interior Follower (typically motion sensors)
 - Day/Night (Usually assigned to sensitive areas where immediate notification of an entry is always wanted.)
 - 24 Hour Silent (Panic button)
 - 24 Hour Audible (Panic button)
 - Silent Burglary (typically a sensor)
 - Fire No Verification (smoke detector)
 - Fire With Verification (smoke detector)
 - Carbon Monoxide (CO detector)

NOTE: Your system may include Zones that do not offer every Zone Type response.

- b. **Restore Zone Type** starts the Smart Scene when any zone with the selected Zone Type returns to its normal state (such as a door closing). The options are the same as **Event Zone Type** options.

NOTE: Event Zone Type and Restore Zone Type are **separate settings**. For example, a given Smart Scene can be triggered by a Fire Alarm (Fire No Verification as the Event Zone Type) OR by an open door closing (Entry/Exit as the Restore Zone Type).

- c. **Trigger** starts the Smart Scene in response to a Fault, Trouble or Alarm in a particular zone or changes to connected devices.

A note about triggering events:

Any change in the state of a security system zone is known as a **Fault**. Faults can include **Trouble** and **Alarm** conditions. Trouble can include low battery or loss of communication with the device. Alarm conditions include zone faults while the system is armed and fire/CO sensors. Fault, Trouble and Alarm conditions can be used to trigger a Smart Scene.

Fault: Any change in the state of a sensor triggers the Scene.

Trouble: Only **Trouble** conditions trigger the Scene

Alarm: Only **Alarm** conditions trigger the Scene.

Choosing one of these events sets the button at right to display **Zone** options.

Smart Scenes can also be triggered by changes in connected **devices** such as lights and locks. These events include:

Light On

Light Off

Door Locked

Door Unlocked

Choosing one of these events sets the button at right to display **Device** options.

- d. Choose **Zone** or **Device**, depending on your selection of a Trigger above. Security zone sensors or devices such as lights and locks are listed.
- e. Select the zone or device and **Save**.
- f. **System Operation** starts Smart Scenes in response to security-related events. Options include:
- Arm Away
 - Arm Stay
 - Disarm
 - Any Burglary Alarm
 - Bell Timeout (end of the programmed time for which an alarm sounds)
 - Start of Entry Delay
 - End of Exit Delay
 - Any Fire Alarm
- g. Select New Action to define the response when the triggering event occurs.
- NOTE:** The 24 Hour Silent Alarm or 24 Hour Auxiliary Alarm Zone types will not trigger the selected Smart Scene if the **Any Burglary Alarm** option is programmed.
9. **New Action** defines the response when the triggering event occurs. This includes users manually running **Anytime** Smart Scenes, the time of **Scheduled** Smart Scenes and the conditions for **Triggered** Smart Scenes. You can choose both Security and automation device responses. The Security choices are:
- Arm the system in Away mode.
 - Arm the system in Stay mode.
 - Disarm the system.
- a. After choosing a Security setting, press ↵ and then **Save**.
- b. If you choose to work with Devices, a list of the system's automation devices appears.

- c. Select one or more devices and set the device's desired operation. (For example, set switches to on or off, or locks to locked or unlocked.)
- d. After adding a device and its desired operation to the Smart Scene, press **Save**. Other available devices are displayed again so that they can be added to the Smart Scene.
NOTE: In most situations, specific Security and Device information is displayed by pressing the Down arrow.

10. Press **Save**.

11. Press **↩** to return to the Smart Scenes menu.

Hold

Hold allows Scheduled and Triggered Smart Scenes to be temporarily suspended.

A **Scheduled** Smart Scene can be put on Hold **before** programmed operations take place.

1. Select a Scheduled or Triggered Smart Scene.
2. Press **Hold**. The button is highlighted, and programmed operation will not take place.

To remove a Hold:

1. On the Smart Scenes menu, enter a user code with access to the desired Smart Scene.
2. Select the Smart Scene and un-highlight **Hold**. Programmed operation will resume.

Run

Smart Scenes can be manually started with the **Run** button. The Smart Scene's results are displayed when the programmed operations have been performed.

NOTE: The **Run** option can be used to check the outcomes of Scheduled Smart Scenes and Triggered Smart Scenes, regardless of programmed triggers.

1. Select the Smart Scene.
2. Press **Run**. The system performs the programmed operations and the results are displayed. Successful operations are displayed with device information and a check mark. Failed operations are displayed with an empty circle.

Show (Review)

Use the **Show** button to see the programmed details of a Smart Scene without running it.

1. Select the Smart Scene.
2. Press **Show**. The scene's category, authorized users and included devices are displayed.

Automation: Voice Command

Home > Security > Tools > Voice Command

Not to be confused with voice announcement of system status (Home > Settings).

Voice Command offers control of Smart Scenes and Video by speaking in plain language. User-selected **trigger phrases** spoken near the Controller alert the system to listen for further instructions. Five **command phrases** can be assigned to trigger Smart Scenes. Assignable command phrases are listed in the [Voice Command Assignment](#) section. The command phrase “Cameras” controls the Video function exclusively.

- NOTES:**
- Voice Commands can only trigger Smart Scenes and launch the Video function. Voice control of individual devices must be part of a Smart Scene triggered by voice.
 - Voice commands **cannot disarm the system in a single step**. If a Smart Scene that disarms the system is triggered by voice command, **a user code is required**.
 - Verbal responses are available in English only.
 - We suggest enabling **Trigger Feedback** (F, below) until you are familiar with Voice Command. However, Voice Command can be used without Trigger Feedback.
 - The Controller is designed to hear commands spoken in a normal voice from about 10 feet away. Background noise may affect Lyric’s ability to recognize commands. You may need to speak louder or move closer when there is a lot of background noise. Adjust the system’s responsiveness using the Command Sensitivity and Trigger Sensitivity sliders along with settings on the Counter menu. See [Counter \(Sensitivity Settings\)](#).
 - You can test voice recognition without setting up Smart Scenes by going to the Home screen and saying your trigger phrase.

Setup

- NOTE:**
- The system should be disarmed before setting up Voice Command.

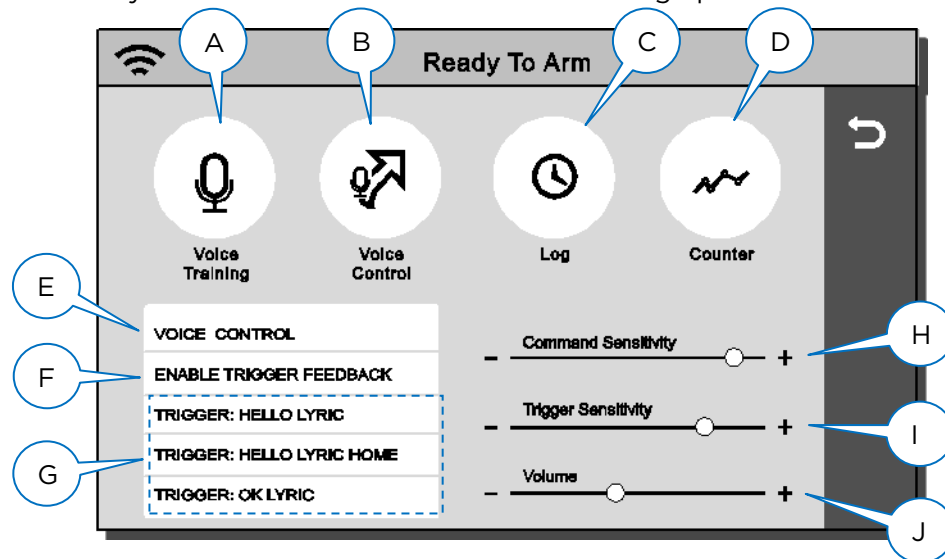

- Familiarize yourself with using Voice Command.
- Assign Smart Scenes to command phrases.
- View a record of Voice Command events.
- View and adjust sensitivity settings. See [Counter \(Sensitivity Settings\)](#), following.
- Turn Voice Command on and off.
- Turn verbal confirmation of trigger phrases on and off.
- Select one of the three available trigger phrases.
- Adjust sensitivity to command phrases to compensate for varying noise conditions.
- Adjust sensitivity to trigger phrases to compensate for varying noise conditions.
- Set volume of trigger feedback (verbal responses to your commands)

Voice Command Assignment

Voice Commands must be assigned to existing Smart Scenes to function. See [Smart Scenes](#) for more information.

- NOTES:**
- Only the “Cameras” command is active without setup. It is not included in the assignable commands listed below.
 - Only one Smart Scene can be associated with a given voice command.

1. On the Voice Setup screen, select Voice Control. The **assignable command phrases** are displayed:



2. Touch a command in the list and press **Select**. A list of Smart Scenes appears.
3. Select the Smart Scene to trigger with the command phrase and press **Save**.
4. The list of command phrases appears, showing the associated Smart Scene.



5. Press ↶ to return to the previous screen.
6. Press ↶ to return to the Tools menu OR press the  button below the touchscreen to return to the Home screen.

Clearing or Changing a Voice Command

1. Select a command phrase with an assigned Smart Scene.
2. Smart Scenes are listed.
3. Press **Clear**.
- OR
4. Select a different Smart Scene.
5. Press **Save**.

Using Voice Command

1. After initial setup, speak the selected trigger phrase (“Hello Lyric”, “Hello Lyric Home” or “Okay Lyric”).
2. Lyric confirms “Hello, please say your command” (if trigger feedback is enabled) and awaits a command phrase.
3. Speak a command phrase. If Trigger Feedback is enabled, Lyric confirms that it is processing the command.
4. Lyric runs the assigned Smart Scene or opens the Video function.

Counter (Sensitivity Settings)

Press  on the Setup menu.

This screen summarizes the interpretation of trigger and command phrases heard by the system.

Assigned	Count	Accuracy	Last 10 Accuracy Levels	
Hello Lyric Home	1	399		Clear
Bedtime	0	201		Clear
Cameras	0	411		Clear
Evening time	0	256		Clear
Leaving the House	0	200		Clear
Returning Home	0	200		Clear
Wake up	0	200		Clear



Clear All

Count	Displays the number of times a trigger or command has been heard by the controller.
Accuracy	The user-set level of sensitivity to spoken trigger and command phrases.
Last 10 Accuracy	Represents the accuracy with which Lyric has interpreted the last 10 voice commands. These figures are based on internal diagnostics. Accuracy values range from 1-2000.
Clear	Resets the Count and Last 10 Accuracy values for a single trigger or command phrase.
Clear All	Resets the Count and Last 10 Accuracy values for all trigger and command phrases.

Adjusting Sensitivity

If users need to repeat commands or speak abnormally loudly, Lyric's responsiveness can be improved by changing the **Accuracy** value.

1. On the list shown above, select the desired phrase.
2. Find the phrase's lowest **Last 10 Accuracy** number.
3. In the **Accuracy column**, press the displayed number. A keypad appears.
4. Enter a number moderately higher than the number cited in step #2. For example, if the lowest Last 10 Accuracy number is 599, set the counter for 800.
5. Press **Done**.

If the results are unsatisfactory, try entering a higher or lower number. Experiment with these settings and the **Command** and **Trigger Sensitivity** sliders for best performance.

Video

Home > Video

The Controller can display live video from as many as eight Wi-Fi-connected cameras.

NOTE: Lyric and its cameras must be on the same Wi-Fi network.

IMPORTANT

If the Controller loses AC power, the Video function is disabled to minimize drain on the backup battery.

If power is lost while you are watching Wi-Fi cameras on the Controller, video display may continue briefly before being suspended.

When power is restored, the Controller looks for available cameras. See [Video Recovery](#).

Remember that interruption of AC power to your Wi-Fi cameras and your router can also affect the Video function, even if the Controller has AC power.

Viewing and Naming Cameras

1. Press **Video** on the Home screen. Video appears in windows or the cameras appear in a list.



OR

The system may **scan** for cameras; when the scan is complete, the camera list appears.

From these screens, you can:

- Press **↵** to return to the Home screen.
 - View live video.
 - Name cameras.
 - Add cameras to the system.
2. Select one or more cameras (as many as four) in the list.
 - When multiple cameras are available, you **may** select as many as four.
 - Selected cameras are highlighted and the **Display** option appears.
 - You can also press **Scan** to search for other available cameras.
 - Press a camera's name again to de-select it.
 3. Select **Display** to see video from the selected camera(s).
 - Select **Camera List** to return to the list view.
 - With multiple cameras displayed, you can select one to work with by tapping its video window.
 4. Viewing a single camera displays its details, which vary with the camera selected.

For all compatible cameras, you can:

- Name the camera. Select **Name** above the video display or **Edit** at right.
- Press **Save** on the on-screen keyboard.
- Press  to show the camera full-screen.
- Press  to return to the detail view.

Some cameras offer additional options such as pan/tilt and built-in lighting.

Adding a Camera

- **Make sure** that the camera is on the **same Wi-Fi network** as the Lyric system.
- Install the camera according to its instructions.

With the camera installed:

1. View or list cameras as above.
2. Press **Scan**. The system looks for available cameras.
3. When the new camera is found, you can name it as described above.

Video Recovery

[Home](#) > [Security](#) > [Tools](#) > [Wi-Fi Config](#)

If video from remote cameras is lost or becomes distorted, the system can attempt to reset video streaming. By default, Lyric automatically begins to recover video about 60 seconds after Wi-Fi communication has been restored.

The default setting is **automatic** video recovery. You may set recovery to begin only by user intervention (**Manual Video Recovery**).

1. Press **Security** on the Home screen.
2. Select **Tools**. Enter the Master User's security code.
3. Press **WiFi Config**.
4. Press **Automatic Video Recovery** repeatedly to choose between automatic and manual operation.

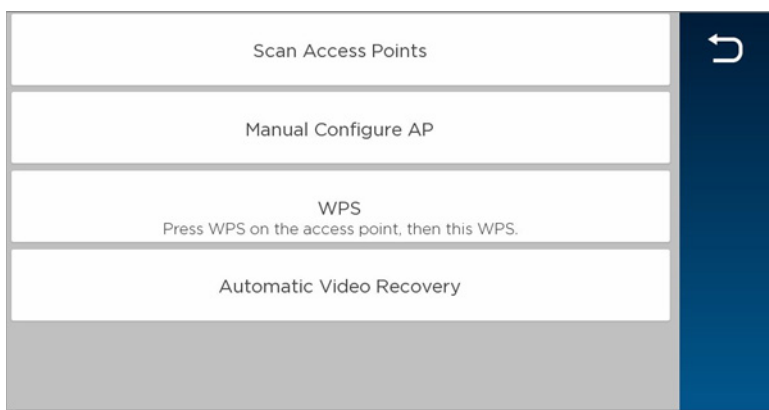

5. Press  to return to the Tools menu.

Users and Security Codes

[Home](#) > [Security](#) > [Tools](#) > [Users](#)

Lyric uses 4-digit codes to restrict certain functions to selected users. A special 4-digit code can be set to trigger the system's **Duress** function.

User codes can be used interchangeably when performing system functions (a system armed with one user's code can be disarmed by another user's code), with the exception of the Guest Code described below.

All users are automatically assigned a **user number**, which cannot be changed. Do not confuse these user numbers with user codes.

User Codes

Master User This code is usually set when the system is installed, and can be changed later. Typically, the Master User is a household member who can perform all system functions.

Only the Master User can add and remove users or modify their settings. Settings include assigning security codes and user names.

Only the Master User can create **Smart Scenes**. Access to Smart Scenes for other users is controlled by the Master User.

User Typical users are household members and other authorized persons who can arm and disarm the security system, with controlled access to other system features.

Guest Visitors and others who are authorized to arm/disarm the system only at certain times or on a temporary basis.

The Guest's user code can be used to **arm** the system, but cannot **disarm** it unless the system was armed using the Guest code. The Guest's user number is **47**.

Duress Code

IMPORTANT

The Duress function requires connection to an alarm monitoring service.

Household members and authorized visitors can enter this code if forced to disarm or arm the system under threat. When the Duress code is entered, Lyric Controllers and keypads appear to behave normally, but the system silently notifies your alarm monitoring service. The Duress Code's user number is **48**.

- NOTES:**
- A security code cannot be assigned more than once. If an existing code is entered, the system displays the warning **User code not accepted!** If this occurs, press **OK** to return to user settings and assign a different code.
 - The system should be disarmed before you work with user codes.
 - Limited-access users such as guests and cleaning staff should not be instructed on system functions other than those they will be using.
 - The number of user codes supported by a Z-Wave door lock can vary between manufacturers. To ensure compatibility with Lyric, set the length of the Master User code on the door lock to be greater than four digits.

Adding Users and Assigning Codes

1. On the Home screen, press **Security**.
2. Press **Tools**, and enter the Master User code.
3. Select **Users**. Existing Users are displayed, along with the Guest and Duress code listings. Four asterisks appear on each listing that has a security code already established. See [User Settings](#) for full details.

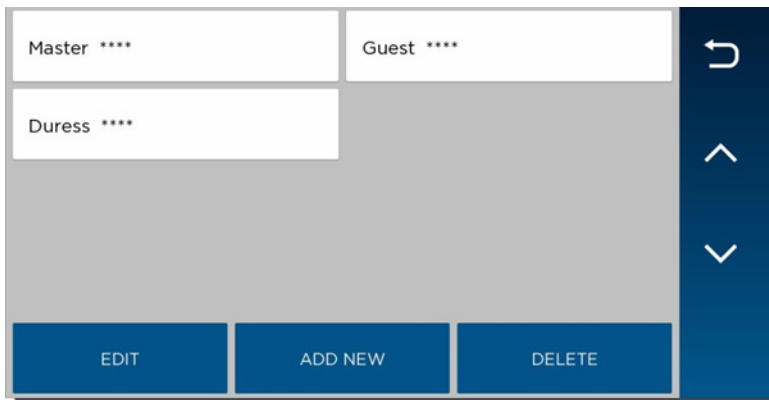

4. Create and change settings in the menu shown here (the details may vary):



- a. **Create User:** Press **Add New** and a new user screen like the one pictured above appears. Set the details as desired.
 - b. **Define/Change Guest Settings:** Press **Guest** and then **Edit**.
 - c. **Set/Change Duress Code:** Press **Duress** and then **Edit**. Enter a 4-digit code.
5. **Save** after making settings. The list of user codes reappears.
 6. Press ↶ to return to the Tools menu.

Changing Security Codes or the Duress Code

The Master User can change other users' names and security codes as well as delete users from the system.

1. Access the **Users** screen as shown above.
2. Select one of the listed users.
3. At the bottom of the screen, press **Edit**. User details appear. **Note** that a user's number in the system, seen at upper right in the user details, cannot be changed.

Deleting a User

The Master user can delete secondary users from the system.

1. Select one of the listed users.
2. At the bottom of the screen, press **Delete**. Lyric requests confirmation.
3. Press **Yes**.

User Settings

User Name

Newly-created users are given a default name. To customize a user's name:

1. Press **Name** at upper left on the display. A keyboard appears.
2. Press **Clear** to delete the default name.
3. Enter the desired name, using as many as 10 characters.
4. **Save**. User details appear.
5. Press **Save** again. The list of users appears, displaying your changes.

User Code

Newly-created users have no security code. To assign a code:

1. Press **User Code**. A keypad appears.
2. Press **Clear** if you are changing an existing code.
3. Enter a four-digit code.
4. Press **Done**. User details appear.
5. **Save**. The list of users appears.

Users and Z-Wave Lock Control

NOTE: This option appears only if Z-Wave devices are connected.

Each user can be given the ability to disarm the system by entering their code to open a Z-Wave lock.

When creating or editing a User:

1. Set **Z-Wave Lock Control** to **Yes**. **Z-Wave Unlocking Door** appears.
2. Select **Disarm**.
3. Press **Save**.

With this setting, entering a user code at any Z-Wave door lock in the system unlocks the door and disarms the security system.

System Settings

Brightness/Volume/Cleaning

[Home](#) > [Settings](#)

Adjust voice and system sounds with the Volume slider. System sounds include zone alert chimes and countdown beeps.

Adjust touchscreen brightness with the Brightness slider.

- NOTES:**
- As the sliders move, the Controller previews changing volume and brightness levels.
 - Voice annunciations are controlled by enabling or disabling Chimes.
 - Volume settings on this menu do **not** affect the Voice Command feature.
 - Some system event notifications can cancel cleaning mode and return the system to normal operation.

Press **Clean** before cleaning the touchscreen. Lyric hides the controls and counts down 15 seconds. During this time, a soft, damp cloth can be used on the screen without affecting the controls. See [Maintenance](#) for more information.

Wi-Fi Configuration

[Home](#) > [Security](#) > [Tools](#) > [Wi-Fi Config](#)

Manage your system's router here. Remember that the Controller and all Wi-Fi cameras must be on the same network.

To View or Join Available Wi-Fi Networks

1. On the Tools menu, press the **Wi-Fi Config** button. A list of Wi-Fi options appears.

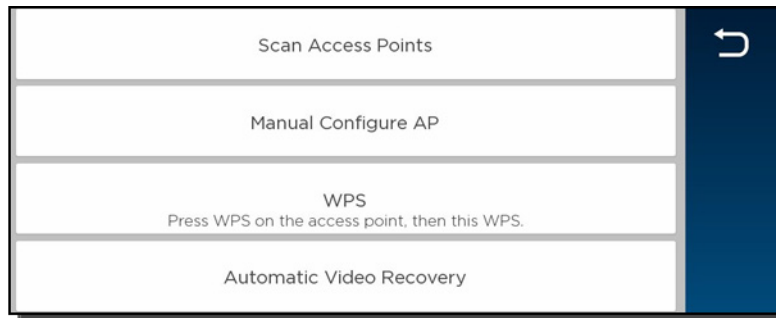

2. Press **Scan Access Points**. A list of available networks is displayed. Use the up and down arrows to scroll through the list. Press **↩** to return to the previous screen.
3. Select the desired network and press **Edit**. The network information is displayed. If a password is required, press **Key** and enter the password.
4. Press **Save**.
5. Press **JOIN**.
6. Press **↩** to return to the previous screen.

Manually Configure Access Point

IMPORTANT

The Security setting below must match the security protocol used by your network router.

1. On the list of Wi-Fi options, press **Manual Config AP**. The Wi-Fi enrollment menu appears. (Fields include **Network Type**, which cannot be changed.)
2. Press **SSID Name**.
3. Enter the network's name.
4. Press **Save**.

5. Press **Security**.
6. Choose the same security protocol as your router. Options include **Open**, **wpa/wpa2** and **WPA2**. (WEP is not supported.)
7. If a password is required, press **Key**, and enter the password.
8. Press **Join**. A confirmation screen appears.
9. Press **OK** and **Save**.
10. Press ↵ to return to the previous screen.

Join a WPS Network

1. On the Controller, have the list of Wi-Fi options ready. Don't press any buttons yet.
2. Press the WPS button on the access point device or router.
3. On the list of Wi-Fi options, press **WPS**. The Controller displays "Please Stand by for WPS Operation".
4. If the operation is successful, the Controller displays "Device has been successfully added to the network".
5. Press **OK**.

If the operation is not successful, the Controller displays **Failed Operation. Device not added to the network**. Press **OK**.

Automatic/Manual Video Recovery

If video from remote cameras is lost or becomes distorted, the system can attempt to reset video streaming. By default, Lyric automatically begins to recover video about 60 seconds after Wi-Fi communication has been restored.

The default setting is automatic video recovery. You may set recovery to begin only by user intervention.

- On the list of Wi-Fi options, toggle between **Automatic Video Recovery** and **Manual Video Recovery**.
- Press ↵ to return to the Tools menu.

Software Updates

[Home](#) > [Security](#) > [Tools](#) > [Advanced](#)

Lyric Controller

Software updates for the Controller are published periodically. Some updates request user permission in an on-screen window. Press **Accept**, **Yes** or **OK** to install the update.

Certain critical updates are installed automatically. After updates of this type, information about the update is displayed on-screen.

You can see the current version of the Controller's software at [Security > Tools > Advanced > System Information](#).

IMPORTANT

After a new SiX™ series sensor or key fob is enrolled in your system, the new device's software should be updated. This ensures that you are using the most up-to-date version of the software.

Sensor Firmware

Normally, SiX™ Series sensors in your system are updated when the Controller's software is updated.

To initiate sensor firmware update manually:

1. On the **Advanced** menu, press **Update Sensor Firmware**.
2. Press **Start** and follow the instructions on the screen.
3. Press **Stop** when the update is complete.
4. Press ↵ to return to the **Advanced** menu.

Key Fob Firmware *(Wireless Keys)*

SiX™ Series wireless keys:

We recommend that you have the key fob handy so you can work with it as instructed during this procedure.

1. On the **Advanced** menu, press **Update Keyfob Firmware**.
2. Press **Start** and follow the instructions on the screen.
3. Press **Stop** when the update is complete.
4. Press ↵ to return to the **Advanced** menu.

Other types of wireless key:

Ask your installer about updating your system's other wireless keys.

Slide Show

[Home](#) > [Security](#) > [Tools](#) > [Slide Show](#)

The Controller can display your favorite photos when idle.

1. On the Tools screen, press ➤ and then **Slide Show**.
2. Connect a USB drive containing your photos (.jpg format only).
3. Press **Load Images**.
The Controller copies compatible files from all folders on the USB drive. When loading is complete, photos are displayed along with slide show options.
4. Remove the USB drive.
5. Select the desired options
 - **Slide Interval**: Time between slides.
 - **Slide After**: Idle time before slide show starts. Select **Disabled** for no slide show.
6. **Save** your settings.

- NOTES:**
- The slide show starts automatically when the Controller is idle.
 - To stop the slide show, touch the screen or the Home button.
 - Store up to 30 photos in the Controller.
 - To remove an image, select it on the Load menu and press **DELETE**.

Date / Time

[Home](#) > [Security](#) > [Tools](#) > [Date Time](#)

Lyric's clock and calendar are normally updated via the Controller's network connections.

If your Controller is operating with no network connections, use these controls to set date and time manually. Don't forget to specify your time zone and Daylight Savings Time if necessary. Be sure to **Save** your changes.

If Lyric is reconnected to the cellular phone network or the Internet, the clock and calendar are updated automatically.

Events

[Home](#) > [Security](#) > [Tools](#) > [Events](#)

The Controller keeps a log of system events such as:

- Arm/Disarm
- Alarm, Trouble and Fault
- Changes in status of Z-Wave devices

The system can save up to 6000 events. When the log is full, the oldest 2000 entries are deleted to make room for logging new events.

Logs can be viewed at the Controller or exported in a variety of file formats.

See [Event Log Codes](#) for a list of logged events and how they are displayed.

Viewing Events

1. On the Tools menu, press **Events**. Lyric lists all events, sorted chronologically.
2. Press **All** to select different sorting options (**Alarm, Trouble, Bypass, Open or Close** or **Non-Security**).
3. Select **All** on the list to return to the view of all events.

Exporting Events

1. Display events as above and press **Export Logs**.
2. When prompted, connect a USB storage device.
3. Select a file format. A progress display appears. When export is complete, the previous screen appears.
4. Remove the USB storage device.

Keypad

[Home](#) > [Security](#) > [Tools](#) > [Keypad](#)

This menu displays the MAC ID of mobile devices connected to Lyric via the **Honeywell Controller** app.

The MAC ID is listed here when the app is first configured for use with Lyric.

To disconnect a device, touch its listing on the screen and press **Delete**.

The Controller requests confirmation; press **Yes** to proceed.

Testing Your System

NOTE: TESTING SHOULD BE PERFORMED WEEKLY.

Before testing, the system should be disarmed and all protected doors and windows closed. The **Home** button should show green.

No alarm messages are sent to your alarm monitoring company during these tests.

Press **Tools** and enter the 4-digit Master User code. Press **Advanced**.

Testing Sensors (Walk Test)

[Home](#) > [Security](#) > [Tools](#) > [Advanced](#) > [Walk Test](#)

Start by pressing **Walk Test**.

The Controller's internal sounder loudly sounds and **Walk Test - Home to Quit** appears. The Controller then beeps every 30 seconds as a reminder that the system is in Test mode.

Note that Walk Test mode automatically quits after 4 hours.

Doors and Windows Open each protected door and window in turn and listen for three beeps from the Controller. If programmed to do so, each zone's voice descriptor is heard. Identification of protection points with problems should appear on the display. Notifications of problem zones clear when the door or window is closed.

Motion Sensors Walk in front of each sensor and listen for three beeps and/or voice descriptors.

The device's identification should appear on the display when it is activated. The display clears when no motion is detected.

NOTE: If wireless motion detectors are in use, there is a 3-minute delay between activations, which helps preserve battery life.

Fire/Carbon Monoxide sensors Follow the manufacturer's instructions to test these devices. When a device is activated, its identification should appear on the touchscreen.

IMPORTANT

When testing smoke detectors, keep the Lyric Controller in test mode for **at least one minute (60 seconds)** after testing the detector to avoid sending unwanted alarm messages to your central station monitoring company.

If there is a problem with any sensor (no confirming sounds, no display), notify your service company.

When all sensors have been checked (and doors and windows closed), no zone identification numbers should be displayed.

Finish by pressing **Home** and entering the Master User code.

Testing Communications

[Home](#) > [Security](#) > [Tools](#) > [Advanced](#) > [Comm. Test](#)

These tests check the system's cellular network and internet (Wi-Fi/Ethernet) connections.

On the Advanced menu, press **Comm. Test**. The options **may** vary with the devices installed in your system. Select the desired option to test connectivity and/or send test messages to the Central Station.

If the test is successful, Lyric displays **Service OK** or **ACK Received**. Details of the test may be shown.

Test Ethernet Checks internet connectivity without sending test messages.

Send Any Sends test messages via all available connections.

**Send Cellular
Message** Sends test messages via cellular network.

**Send Ethernet
Message** Sends test messages via internet.

Finish by pressing **↵** to run a different test or by pressing **Home**. Enter the Master User code if prompted.

Reboot

[Home](#) > [Security](#) > [Tools](#) > [Advanced](#) > [Reboot](#)

Press **Reboot** to restart the Controller if required. The system requests confirmation (“**Are You Sure?**”). Press **Yes** to proceed.

Maintenance

The Lyric Controller is designed to require little maintenance. However, testing your system is strongly recommended, and regular cleaning is suggested.

- Test the system weekly.
 - Test your system after any alarm occurs.
- See [Testing Your System](#) for more information.*

Care and Cleaning

- Do not slam sensor-protected doors or windows.
- Keep dust from accumulating on the touchscreen and sensors, particularly motion sensors and smoke or carbon monoxide detectors.
- The touchscreen and sensors should be cleaned carefully with a soft, dry cloth. Do not clean the components with water or any other liquids.
- We recommend cleaning the touchscreen weekly.

Select **Settings**  on the Home screen.

Press **Clean**. During the 15 second countdown, a soft, damp cloth can be used on the screen without affecting the controls.

NOTE: When the security system is armed, system event notifications will cancel the cleaning mode and return the system to normal operation. When the system is disarmed, only certain notifications will cancel cleaning mode.

Battery Replacement

[Home](#) > [Security](#) > [Tools](#) > [Advanced](#) > [Install Backup Battery](#)

IMPORTANT

Replace the battery pack when the Security menu displays **Low Battery** with no zone number specified.

Use only batteries recommended by the installer or the manufacturer.

Disarm the system before changing the Controller's battery pack.

Remember that you must enter the Master User code for access to the Tools menu.

Lyric Controller

1. Select **Advanced** on the **Tools** menu.
2. Select **Install Backup Battery**. Lyric requests confirmation that you want to proceed.
3. Press **Yes** and **leave the battery installation procedure screen open**.
4. Open the Controller's case. If wall mounted, hang it from the self-contained hook as shown below.

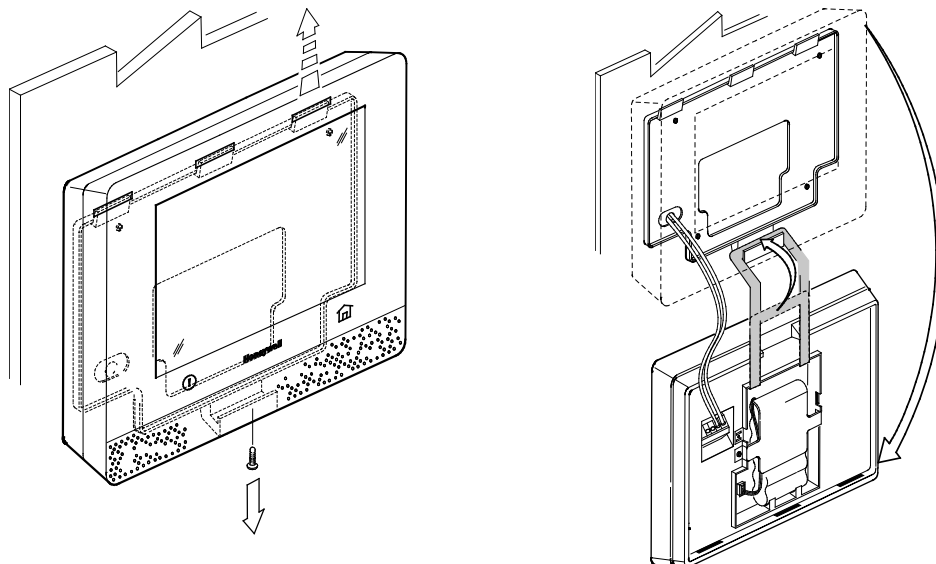

5. Unplug the battery and remove it as seen below.

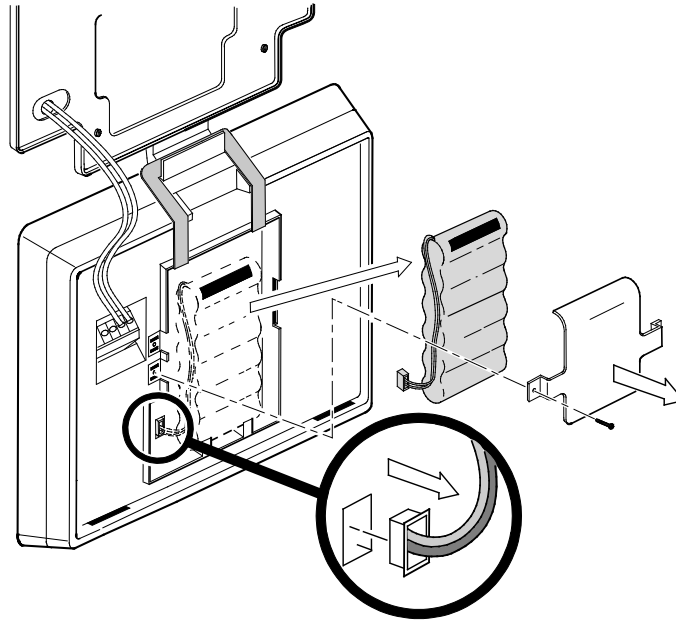

6. Install the replacement battery; remember to replace the connector inside the battery compartment.
7. Depending on your choice of a standard- or high-capacity replacement battery, position the battery retainer clip as seen below.

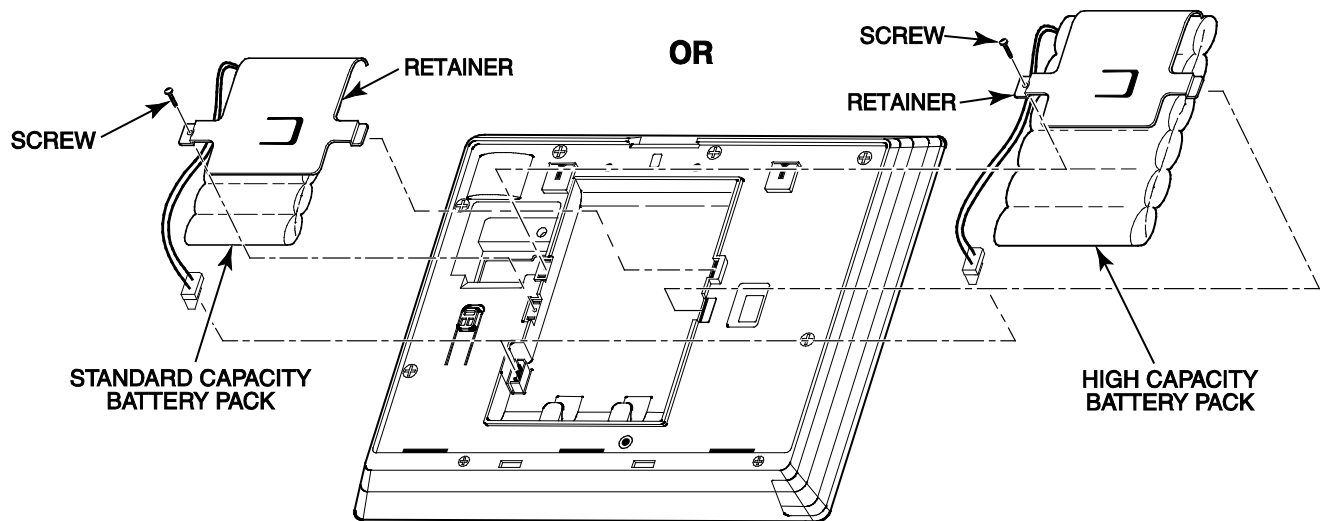

8. Close the case and replace the screw shown in Step 4.
9. Return the Controller to its mounting location.
10. Press **OK** on the battery installation procedure screen.
11. The system confirms "Battery successfully installed".
12. Press **OK**. The system returns to the Advanced menu.
13. Press **↶** to return to the previous screen(s).

Sensors

Clear sensor low-battery warnings by entering a user code on the Controller. Follow the sensor's battery replacement instructions.

- NOTES:**
- For SiX™ series smoke sensors, remove the battery and **wait** for 2 minutes before installing the replacement battery.
 - For other SiX™ series sensors and wireless keys, remove the battery and wait about 10 seconds before installing the replacement battery.

Communication Module Replacement

[Home](#) > [Security](#) > [Tools](#) > [Advanced](#) > [Install Cellular Module](#)

Refer to the illustrations below and follow these steps to replace a communication module:

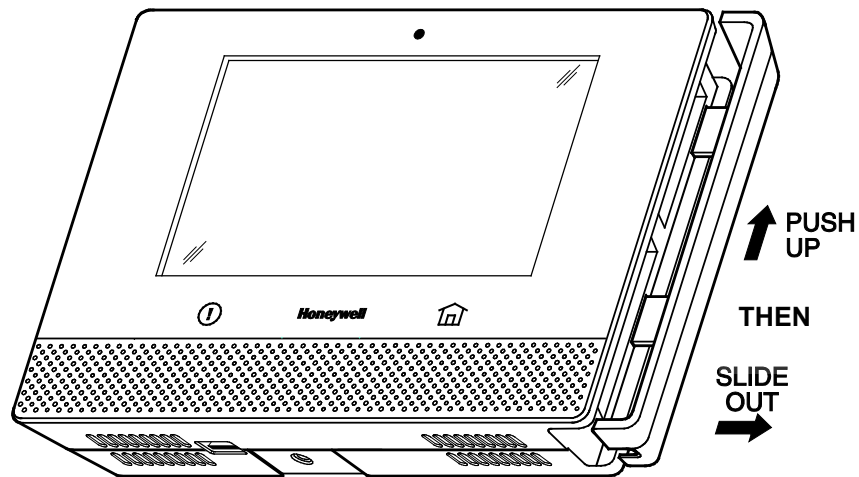

Removing the Bezel

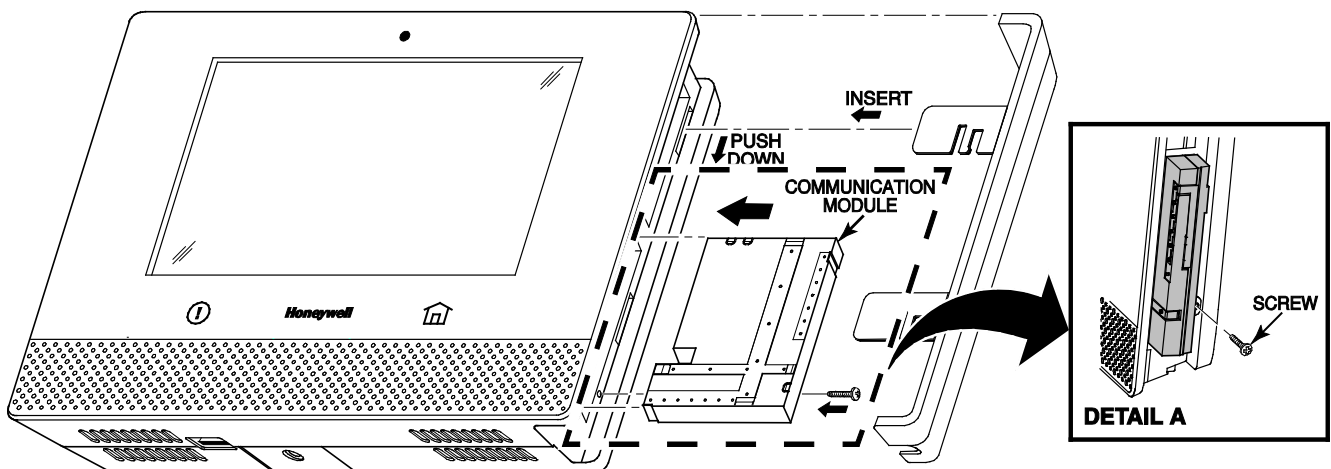

Installing the Communication Module

1. With the system not armed, select **Tools** on the Security menu.
2. Enter the 4-digit Master User code.
3. Select **Advanced**.
4. Select **Install Cellular Module**.
Follow the on-screen instructions for changing the module.
5. Press **OK** on the screen in step 4. The system confirms installation.
6. Press **OK**. The system returns to the Advanced menu.
7. Reboot the Controller (see [Reboot](#) for details).

SYSTEM DISPLAY and Buttons

Zone numbers, location and other information may be displayed with status indications. Failure and Trouble indications and on-screen Panic buttons appear in red.

Home Screen

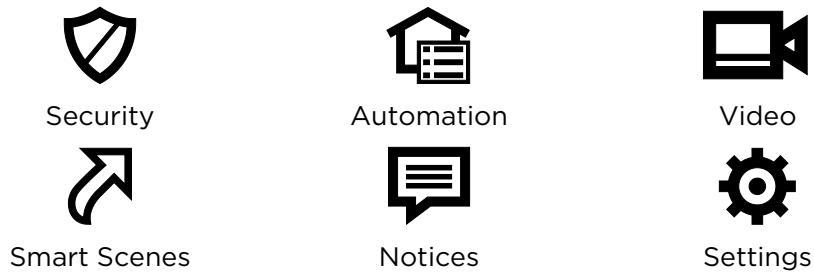

Control Panel Buttons

Below Touchscreen

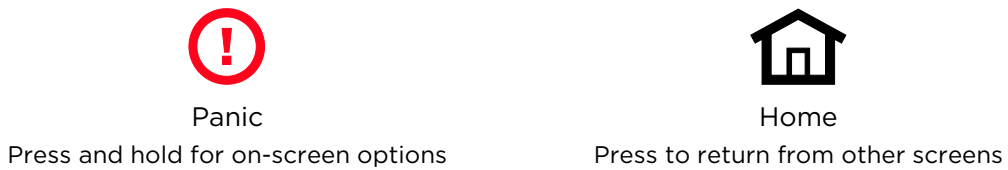

On-screen Panic Buttons





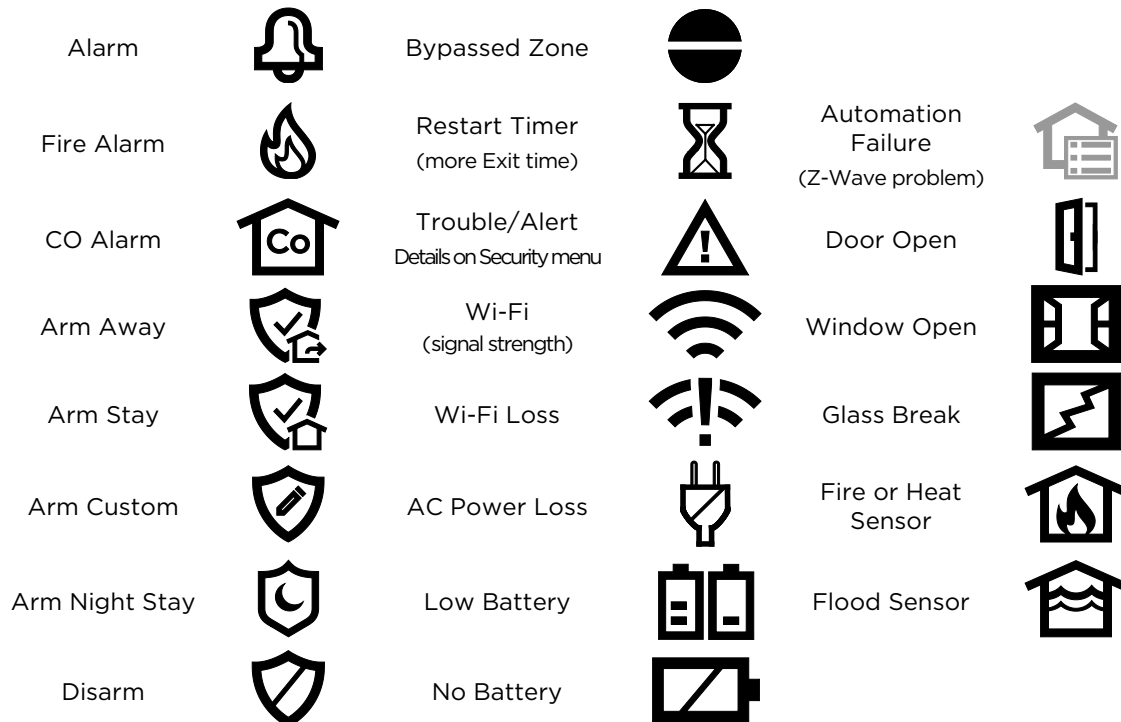















System Status and Security



Features/Various

Icons may appear in red or orange to indicate device status. Problems involving Z-Wave devices are indicated by the Automation icon appearing in gray on the Home screen.

Clean Control Panel		Date/Time		Automation	
Tools		Reminders		Switches	
Users		Voice Command		Thermostats	
Events		Wi-Fi Config		Locks	
Advanced		Slide Show		Garages	
Keypad		Notices		Water Valves	
		Message			

WIRELESS KEYS

Key Assignments

Your wireless keys (key fobs) are set up by your installer. You might wish to write down each button's preprogrammed function in the space below.

- NOTES:
- One or more buttons may have been programmed for Panic function.
 - To activate a button function, press and hold the button for 1-2 seconds.

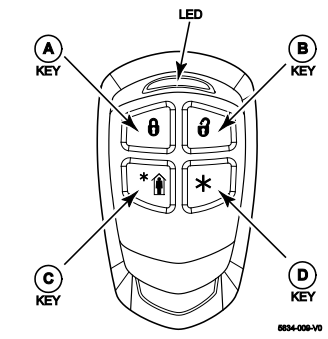
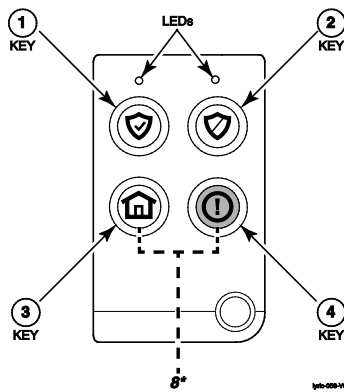
<p>Button A: _____</p> <p>Button B: _____</p> <p>Button C: _____</p> <p>Button D: _____</p>	<p>5800 Series wireless key</p> 
<p>Button 1: _____</p> <p>Button 2: _____</p> <p>Button 3: _____</p> <p>Button 4: _____</p> <p>Button 8*: _____ (press and hold BOTH buttons to activate)</p>	<p>SiX™ Series wireless key</p> 

SIXFOB Wireless Key Status Indications

Press and release any key for system status. Status is indicated by the LEDs at the top of the key fob.

Green LEDs	Red LEDs	Sounder	System Status
Rapid Flash – Alternating about 8-20 seconds, then ON for 3 seconds	Off	Chirp for confirmation	Device Enrollment
Off	ON 2-3 seconds	2 Beeps	System Armed (any mode)
Off	Slow Flash for 2-3 seconds	4 Beeps	Alarm in progress or system in Audible Panic Mode
ON 2-3 seconds	Off	1 Beep	Disarmed, Ready to Arm
Slow Flash for 2-3 seconds	Off	Silent	Disarmed, Not Ready to Arm
Flash once (both LEDs)	Off	Silent	RF Transmission
Off	Off	1 Second beep	Not Hearing from Controller
Rapid Flash for 2 seconds	Off	Silent	Deleting wireless key from system

Event Log Codes

The Lyric Controller’s Event Log can record and display as many as 6000 system events. Events are stored locally in the Controller, in chronological order and sent to your monitoring company as needed. When the maximum number of stored events is reached, the oldest 2000 entries are deleted to make room for logging new events.

The type of events that can be recorded is selectable; refer to the **Lyric Controller Installation and Reference Guide’s** Programming section. The Events and CID Codes displayed vary with your system’s options. The tables below provide definitions of the events/codes that may be transmitted to the Central Station and/or displayed by the controller.

Note: If the Controller’s backup battery is exhausted after AC power is lost, any system activity occurring after Low Battery notification is not saved. Additionally, the Controller will revert to the status condition as before the low battery notification.

Contact ID® Event Log Codes		
CID Code	Definition	Event Log Display
110	Alarm, Fire	Fire
121	Alarm, Duress	Duress
122	Alarm, Silent	Silent
123	Alarm, Audible	Audible
131	Alarm, Perimeter	Perimeter
132	Alarm, Interior	Interior
134	Alarm, Entry/Exit	Entry/Exit
135	Alarm, Day/Night	Day Night
137	Alarm, Tamper	Tamper
145	Expansion Module Tamper	Expansion Module Tamper
146	Silent Burglary	Silent Burglary
150	24-Hour Non-Burglary	24 Hour Non-Burglary
162	Carbon Monoxide Detected	Carbon Monoxide Detected
301	Trouble, AC Loss	AC Loss
302	Trouble, Low System Battery	Low system battery
305	Trouble, System Reset	System Reset
308	System shutdown	System shutdown
316	System Tamper*	System Tamper
341	Trouble, Case Tamper	Cover Tamper
344	Trouble, RF Receiver Jam Detect	RF Jam Detect
350	Long Range Radio Reset	Long Range Radio Reset
353	Trouble, Long Range Radio Transmitter Fault	Comm. Trouble
354	Failure to Communicate Event	Failure to Communicate Event
373	Trouble, Fire Trouble	Fire trouble
374	Trouble, Exit Error Alarm	Exit error alarm
380	Trouble, Sensor	Sensor trouble
381	Trouble, Loss of Supervision RF	Superv Loss-RF
383	Trouble, Sensor Tamper	Sensor Tamper

Continued next page

Contact ID® Event Log Codes

384	RF Low Battery	RF Low Battery
401	Open/Close by User	Arm Away/Disarmed
403	Open/Close Automatic	Automatic O/C (or Scheduled Arming)
406	Cancel	Cancel
407	Remote Arm/Disarm	Remote Arm/Disarm
408	Quick Arm	Quick arm
441	Armed Stay	Arm Stay/Disarmed
455	Auto-Arm Failed	Auto-arm Failed
459	Recent Close	Recent Closing
461	Wrong Code Entry	Wrong Code Entry
570	Zone/Sensor Bypass	Zone Bypass
601	Manual Trigger Test Report	Manual Trigger Test Report
602	Periodic Test Report	Periodic test report
606	Listen-in to follow	Listen-in to follow
607	Walk Test	Walk Test Mode
623	Event 90% Full	Event Log 90% Full
627	Program Mode Entry	Program mode entry
628	Program Mode Exit	Program mode exit
654	System Inactivity	System Inactivity
655	Reset Master Code	User Code

*If APL is enabled, AlarmNet 360™ will generate a special **comm. fail** message (E316) if it does not hear from a unit within 15 minutes after a delayed alarm is delivered. This message is meant to alert the Central Station that the system has been tampered with and may have been compromised.

Central Station Messages

The following messages are sent by the controller internal cellular or WiFi devices for the conditions listed below.

Alarm Condition	Alarm Code	Restore Code
Power On / Reset	E33900950	
Primary Communication Path Supervision	E350C0951	R350C0951
Secondary Communication Path Supervision	E350C0952	R350C0952
Test	55555559	

Glossary

Zone	Specific areas of protection in your home. Sensing devices are assigned to these numbered Zones, with designations such as front door, kitchen window, etc. Zone numbers appear on the display when an alarm or fault occurs.
Disarm	Turns off the security portion of the system. Silences alarms and trouble indicators.
Arm Away	Enables all exterior and interior security protection provided by door and window sensors and motion detectors.
Arm Stay	Enables exterior protection; sounds an alarm if protected doors or windows are disturbed. Allows bypassing of selected zones, permitting movement within the home without unwanted alarms.
Arm Custom	Allows authorized users to arm the system with selected zones bypassed or with entry delays disabled.
Quick Arm	Allows household members to arm the system without entering a user code. This feature can only be enabled by an authorized user.
Quick Exit	Allows an outside door to be opened for a set time period. This feature is used for checking the mailbox, retrieving the newspaper, etc.
Bypass	Allows authorized users to exclude selected protection zones when arming the system.
Panic	Special keys on the controller activate sounders on the premises and optionally send alert messages in various types of emergency. Connection to a central monitoring service is required for outside emergency calls.
Duress	Special code that can be entered into the system instead of a normal user code. Sends a silent call for assistance while the Controller appears to behave normally. Requires connection to a central monitoring service.

Z-Wave

Controller	<p>The primary controller is the main device used to set up and control the Z-Wave network. There can only be one primary controller and it must be used to add/Include or delete/Exclude devices. A primary controller can be a portable device such as a hand-held remote, a permanently mounted control panel, a Z-Wave enabled PC or a Z-Wave enabled Ethernet router/bridge.</p> <p>A secondary controller cannot be used to add or delete devices. If the secondary controller is the same model as the primary, it will have all of the primary's capabilities, but cannot be used to add or delete devices.</p>
Include	Including a device pairs it with the Controller so the two can communicate. In this document, the term Include is used interchangeably with "Add".
Exclude	When a device is Excluded, it is removed from the system. Excluding the device also removes the network pairing from the device's memory. In this document, the term Exclude is used interchangeably with "Delete".

Important Note: A device must be Excluded before it can be moved to another network or re-Included after a controller reset.

Fire/CO Alarm System

Your fire alarm system (if installed) is active 24 hours a day, providing continuous protection. In the event of an emergency, the installed smoke, heat and/or carbon monoxide detectors will automatically activate your security system, triggering a loud, intermittent tone from the touchscreen. The sound alternates with the voice announcement, sounding every 15 seconds. A "FIRE" or "CO" message will appear at your touchscreen and remain on until you silence and clear the alarm display.

In Case of Fire

1. Should you become aware of a fire emergency before your detectors sense the problem, go to the Controller and press and hold the Panic button and then select the Fire icon. The alarm will sound and an alarm will be transmitted to the central station.
2. Evacuate all occupants from the premises.
3. If flames and/or smoke are present, leave the premises and notify your local Fire Department immediately.
4. If no flames or smoke are apparent, investigate the cause of the alarm. The zone number of the zone(s) in an alarm condition will appear on the touchscreen.

In Case of Carbon Monoxide Alarm

1. If a high level of carbon monoxide is detected you should evacuate all occupants from the premises and immediately move to a location where fresh air is available, preferably outdoors.
2. From a safe area, contact your central monitoring company for further instructions.

Silencing a Fire/Carbon Monoxide Alarm

1. Silence the alarm by entering the Master User code.
2. To clear the alarm, enter the Master User code again.
3. If the touchscreen indicates a trouble condition after entering the Master User code a second time, check that smoke detectors are not responding to smoke- or heat-producing objects in their vicinity. Should this be the case, eliminate the source of heat or smoke.
4. If this does not remedy the problem, there may still be smoke in the detector. Clear it by fanning the detector for about 30 seconds.
5. When the problem has been corrected, clear the display by entering Master User code again.

National Fire Protection Association Smoke Detector Recommendations

With regard to the number and placement of smoke and heat detectors, we subscribe to the recommendations contained in the National Fire Protection Association's (NFPA) Standard #72 noted below.

Early warning fire detection is best achieved by the installation of fire detection equipment in all rooms and areas of the household. The equipment should be installed as follows: A smoke detector installed outside of each separate sleeping area, in the immediate vicinity of the bedrooms and on each additional story of the family living unit, including basements and excluding crawl spaces and unfinished attics.

In addition, the NFPA recommends that you install heat or smoke detectors in the living room, dining room, bedroom(s), kitchen, hallway(s), attic, furnace room, utility and storage rooms, basements and attached garages.

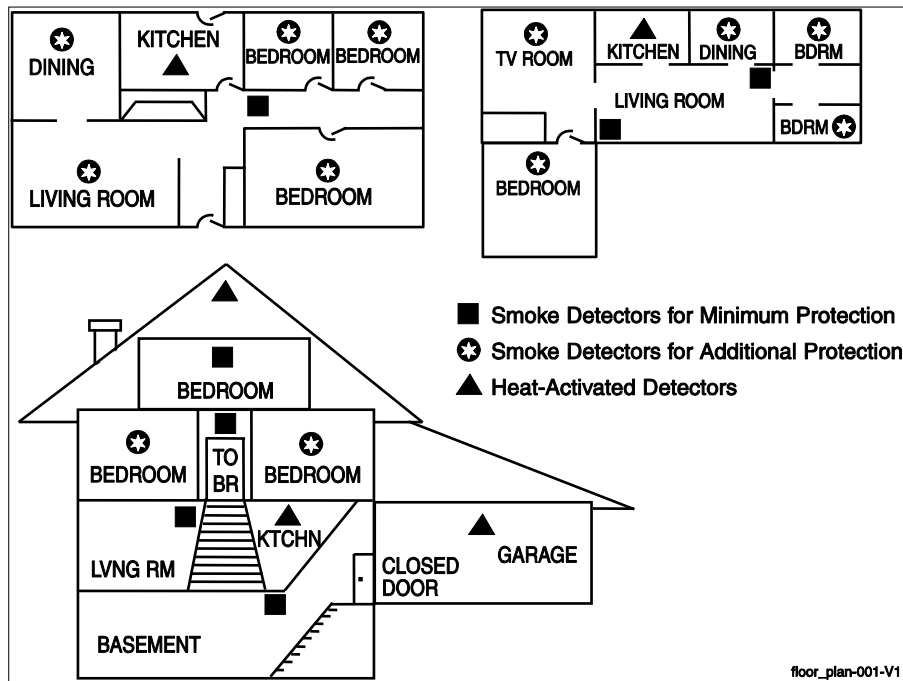

Emergency Evacuation

Establish and regularly practice a plan of escape in the event of fire. The following steps are recommended by the National Fire Protection Association:

1. Position your detector or your interior and/or exterior sounders so that they can be heard by all occupants.
2. Determine two means of escape from each room. One path of escape should lead to the door that permits normal exit from the building. The other should be an alternative escape, such as a window, should your path to that door be unpassable. Station an escape ladder at such windows if there is a long drop to the ground.
3. Sketch a floor plan of the building. Show windows, doors, stairs and rooftops that can be used to escape. Indicate escape routes for each room. Keep these routes free from obstruction and post copies of the escape routes in every room.
4. Assure that all bedroom doors are shut while you are asleep. This will prevent deadly smoke from entering while you escape.
5. Try the door. If the door is hot, check your alternate escape route. If the door is cool, open it cautiously. Be prepared to slam the door if smoke or heat rushes in.
6. When smoke is present, crawl on the ground. Do not walk upright, since smoke rises and may overcome you. Clearer air is near the floor.
7. Escape quickly; don't panic.
8. Establish a place outdoors, away from your house, where everyone can meet and then take steps to contact the authorities and account for those missing. Choose someone to assure that nobody returns to the house — many die going back.

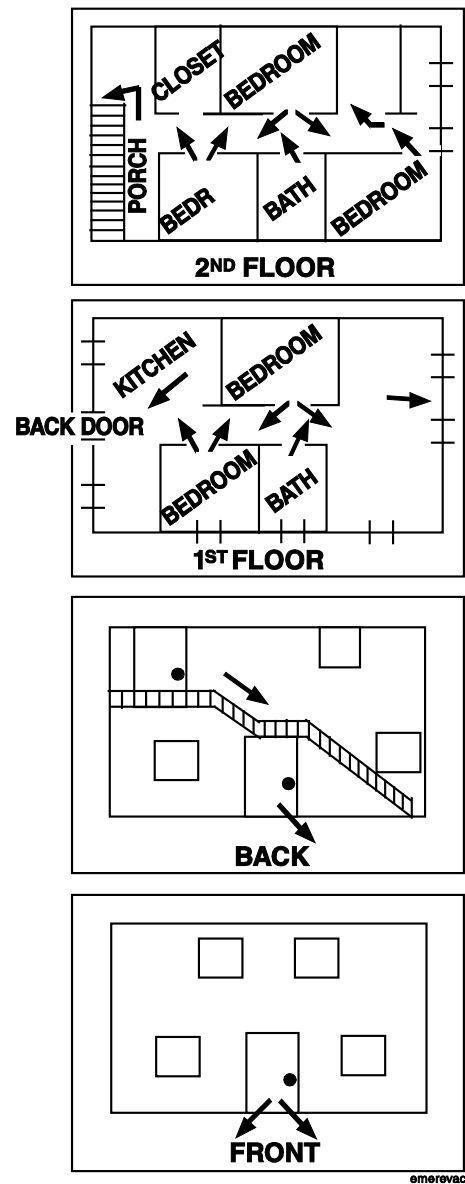

emerevac

Regulatory Agency Statements

FEDERAL COMMUNICATIONS COMMISSION (FCC) & INDUSTRY CANADA (IC) STATEMENTS

The user shall not make any changes or modifications to the equipment unless authorized by the Installation Instructions or User's Manual. Unauthorized changes or modifications could void the user's authority to operate the equipment.

CLASS B DIGITAL DEVICE STATEMENT

This equipment has been tested to FCC requirements and has been found acceptable for use. The FCC requires the following statement for your information:

This equipment generates and uses radio frequency energy and if not installed and used properly, that is, in strict accordance with the manufacturer's instructions, may cause interference to radio and television reception. It has been type tested and found to comply with the limits for a Class B computing device in accordance with the specifications in Part 15 of FCC Rules, which are designed to provide reasonable protection against such interference in a residential installation. However, there is no guarantee that interference will not occur in a particular installation. If this equipment does cause interference to radio or television reception, which can be determined by turning the equipment off and on, the user is encouraged to try to correct the interference by one or more of the following measures:

- If using an indoor antenna, have a quality outdoor antenna installed.
- Reorient the receiving antenna until interference is reduced or eliminated.
- Move the radio or television receiver away from the receiver/control.
- Move the antenna leads away from any wire runs to the receiver/control.
- Plug the receiver/control into a different outlet so that it and the radio or television receiver are on different branch circuits.
- Consult the dealer or an experienced radio/TV technician for help.

INDUSTRY CANADA CLASS B STATEMENT

This Class B digital apparatus complies with Canadian ICES-003.

Cet appareil numérique de la classe B est conforme à la norme NMB-003 du Canada.

FCC / IC STATEMENT

This device complies with Part 15 of the FCC Rules, and RSS-210 of Industry Canada. Operation is subject to the following two conditions: (1) This device may not cause harmful interference, and (2) This device must accept any interference received, including interference that may cause undesired operation.

Cet appareil est conforme à la partie 15 des règles de la FCC & de RSS-210 des Industries Canada. Son fonctionnement est soumis aux conditions suivantes: (1) Cet appareil ne doit pas causer d'interférences nuisibles. (2) Cet appareil doit accepter toute interférence reçue y compris les interférences causant une réception indésirable.

RF EXPOSURE WARNING



The antenna(s) used for this transmitter must be installed to provide a separation distance of at least 7.8 in (20 cm) from all persons and must not be co-located or operated in conjunction with any other transmitter except in accordance with FCC multi-transmitter product procedures.

MISE EN GARDE

Exposition aux Fréquences Radio: L'antenne (s) utilisée pour cet émetteur doit être installée à une distance de séparation d'au moins 7,8 pouces (20 cm) de toutes les personnes.

IMPORTANT NOTE ABOUT EXTERNAL ANTENNAS

If an external cellular radio antenna is used, the antenna may be installed or replaced ONLY by a professional installer.

TO THE INSTALLER

The external antenna must not exceed a maximum directional gain (including cable loss) of 3.2 dBi at 850 MHz and 2.3 dBi at 1900 MHz.

OWNER'S INSURANCE PREMIUM CREDIT REQUEST

This form should be completed and forwarded to your homeowner's insurance carrier for possible premium credit.

A. GENERAL INFORMATION:

Insured's Name and Address: _____

Insurance Company: _____ Policy No.: _____

Lyric Controller _____ **Other** _____

Type of Alarm: Burglary Fire Both

Installed by: _____ Serviced by: _____
Name Name

Address Address

B. NOTIFIES (Insert B = Burglary, F = Fire)

Local Sounding Device _____ Police Dept. _____ Fire Dept. _____

Central Station Name: _____
Address: _____
Phone: _____

C. POWERED BY: A.C. with Rechargeable Power Supply

D. TESTING: Quarterly Monthly Weekly Other _____

E. SMOKE DETECTOR LOCATIONS

Furnace Room Kitchen Bedrooms Attic
 Basement Living Room Dining Room Hall

F. BURGLARY DETECTING DEVICE LOCATIONS:

Front Door Basement Door Rear Door All Exterior Doors
 1st Floor Windows All Windows Interior Locations
 All Accessible Openings, Including Skylights, Air Conditioners and Vents

G. ADDITIONAL PERTINENT INFORMATION:

Signature: _____ Date: _____

Limitations of This Alarm System

WARNING!

While this system is an advanced design security system, it does not offer guaranteed protection against burglary or fire or other emergency. Any alarm system, whether commercial or residential, is subject to compromise or failure to warn for a variety of reasons. For example:

- Intruders may gain access through unprotected openings or have the technical sophistication to bypass an alarm sensor or disconnect an alarm warning device.
- Intrusion detectors (e.g. passive infrared detectors), smoke detectors, and many other sensing devices will not work without power. Battery operated devices will not work without batteries, with dead batteries, or if the batteries are not put in properly. Devices powered solely by AC will not work if their AC power supply is cut off for any reason, however briefly.
- Signals sent by wireless transmitters may be blocked or reflected by metal before they reach the alarm receiver. Even if the signal path has been recently checked during a weekly test, blockage can occur if a metal object is moved into the path.
- A user may not be able to reach a panic or emergency button quickly enough.
- While smoke detectors have played a key role in reducing residential fire deaths in the United States, they may not activate or provide early warning for a variety of reasons in as many as 35% of all fires, according to data published by the Federal Emergency Management Agency. Some of the reasons smoke detectors used in conjunction with this System may not work are as follows. Smoke detectors may have been improperly installed and positioned. Smoke detectors may not sense fires that start where smoke cannot reach the detectors, such as in chimneys, in walls, or roofs, or on the other side of closed doors. Smoke detectors also may not sense a fire on another level of a residence or building. A second floor detector, for example, may not sense a first floor or basement fire. Moreover, smoke detectors have sensing limitations. No smoke detector can sense every kind of fire every time. In general, detectors may not always warn about fires caused by carelessness and safety hazards like smoking in bed, violent explosions, escaping gas, improper storage of flammable materials, overloaded electrical circuits, children playing with matches, or arson. Depending upon the nature of the fire and/or the locations of the smoke detectors, the detector, even if it operates as anticipated, may not provide sufficient warning to allow all occupants to escape in time to prevent injury or death.
- Passive Infrared Motion Detectors can only detect intrusion within the designed ranges as diagrammed in their installation manual. Passive Infrared Detectors do not provide volumetric area protection. They do create multiple beams of protection, and intrusion can only be detected in unobstructed areas covered by those beams. They cannot detect motion or intrusion that takes place behind walls, ceilings, floors, closed doors, glass partitions, glass doors, or windows. Mechanical tampering, masking, painting or spraying of any material on the mirrors, windows or any part of the optical system can reduce their detection ability. Passive Infrared Detectors sense changes in temperature; however, as the ambient temperature of protected area approaches the temperature range of 90° to 105°F, the detection performance can decrease.
- Alarm warning devices such as sirens, bells or horns may not alert people or wake up sleepers if they are located on the other side of closed or partly open doors. If warning devices sound on a different level of the residence from the bedrooms, then they are less likely to waken or alert people inside the bedrooms. Even persons who are awake may not hear the warning if the alarm is muffled from a stereo, radio, air conditioner or other appliance, or by passing traffic. Finally, alarm warning devices, however loud, may not warn hearing-impaired people or waken deep sleepers.
- Communication paths needed to transmit alarm signals from a premises to a central monitoring station may be out of service or temporarily out of service. Communication paths are also subject to compromise by sophisticated intruders.
- Even if the system responds to the emergency as intended, however, occupants may have insufficient time to protect themselves from the emergency situation. In the case of a monitored alarm system, authorities may not respond appropriately.
- This equipment, like other electrical devices, is subject to component failure. Even though this equipment is designed to last as long as 10 years, the electronic components could fail at any time.

The most common cause of an alarm system not functioning when an intrusion or fire occurs is inadequate maintenance. This alarm system should be tested weekly to make sure all sensors and transmitters are working properly.

Installing an alarm system may make one eligible for lower insurance rates, but an alarm system is not a substitute for insurance. Homeowners, property owners and renters should continue to act prudently in protecting themselves and continue to insure their lives and property.

We continue to develop new and improved protection devices. Users of alarm systems owe it to themselves and their loved ones to learn about these developments.

Your System Information

Your local Honeywell dealer is the person best qualified to service your alarm system. Arranging a program of regular service is advisable.

Security Company/Installer:

Name: _____

Address: _____

Phone: _____

DELAY DURATIONS AND ARMING OPTIONS

Exit Delay time		
Entry Delay time 1		
Entry Delay time 2		
NIGHT STAY enabled zones		
QUICK ARM enabled?	Yes	No

SYSTEM USERS

Keep track of authorized system users in the chart below. This record should be kept secure by the Master User.

User #	User Code	Comment/Description
02 (preset)	Master User	Can add and modify Users. Can add, modify, edit and run all Smart Scenes.
47 (preset)	Guest	The Guest user code can be used to arm the system, but cannot disarm it unless the system was armed using the Guest code.
48 (preset)	Duress	Enter this code if forced to disarm/arm the system under threat. System appears to behave normally, but silently notifies alarm monitoring service.
03		
04		
05		
06		
07		
08		
09		
10		
11		
12		
13		
14		

SMART SCENES		
Name	Voice Command assigned?	Description

TWO YEAR LIMITED WARRANTY

Honeywell International Inc., acting through its Security & Communications business ("Seller"), 2 Corporate Center Drive, Melville, New York 11747 warrants its products to be free from defects in materials and workmanship under normal use and service, normal wear and tear excepted, for 24 months from the manufacture date code; provided, however, that in the event the Buyer presents a proper invoice relating to the purchased product and such invoice bears a date later than the manufacture date, then Seller may at its discretion, reflect the warranty period as commencing at invoice date. Except as required by law, this Limited Warranty is only made to Buyer and may not be transferred to any third party. During the applicable warranty period, Seller will repair or replace, at its sole option and as the exclusive remedy hereunder, free of charge, any defective products.

Seller shall have no obligation under this Limited Warranty or otherwise if the product:

- (i) is improperly installed, applied or maintained;
- (ii) installed outside of stated operating parameters, altered or improperly serviced or repaired by anyone other than the Seller/Seller's Authorized Service/Repair Center;
- (iii) damage is caused by outside natural occurrences, such as lightning, power surges, fire, floods, acts of nature, or the like; or
- (iv) defects result from unauthorized modification, misuse, vandalism, alterations of serial numbers, other causes unrelated to defective materials or workmanship, or failures related to batteries of any type used in connection with the products sold hereunder.

Exceptions to Warranty With Respect to Honeywell Products listed below:

Hardwire Contacts and PIRs - Seller warrants parts for hardwire contacts and PIRs in accordance with the terms of the above limited warranty for a period of five (5) years from the manufacture date code.

EXCLUSION OF WARRANTIES, LIMITATION OF LIABILITY

THERE ARE NO WARRANTIES OR CONDITIONS, EXPRESS OR IMPLIED, OF MERCHANTABILITY, OR FITNESS FOR A PARTICULAR PURPOSE OR OTHERWISE, WHICH EXTEND BEYOND THE DESCRIPTION ON THE FACE HEREOF. TO THE FULLEST EXTENT PERMITTED BY LAW, IN NO CASE SHALL SELLER BE LIABLE TO ANYONE FOR ANY (i) CONSEQUENTIAL, INCIDENTAL, INDIRECT, SPECIAL, OR PUNITIVE DAMAGES ARISING OUT OF OR RELATING IN ANY WAY TO THE PRODUCT AND/OR FOR BREACH OF THIS OR ANY OTHER WARRANTY OR CONDITION, EXPRESS OR IMPLIED, OR UPON ANY OTHER BASIS OF LIABILITY WHATSOEVER, EVEN IF THE LOSS OR DAMAGE IS CAUSED BY SELLER'S OWN NEGLIGENCE OR FAULT AND EVEN IF SELLER HAS BEEN ADVISED OF THE POSSIBILITY OF SUCH LOSSES OR DAMAGES. Any product description (whether in writing or made orally by Seller or Seller's agents), specifications, samples, models, bulletin, drawings, diagrams, engineering sheets or similar materials used in connection with the Buyer's order are for the sole purpose of identifying the Seller's products and shall not be construed as an express warranty or condition. Any suggestions by Seller or Seller's agents regarding use, applications, or suitability of the products shall not be construed as an express warranty or condition unless confirmed to be such in writing by Seller. Seller does not represent that the products it sells may not be compromised or circumvented; that the products will prevent any personal injury or property loss by burglary, robbery, fire or otherwise, or that the products will in all cases provide adequate warning or protection. Buyer understands that a properly installed and maintained alarm may only reduce the risk of a burglary, robbery or fire without warning, but it is not insurance or a guarantee that such will not occur or will not cause or lead to personal injury or property loss. CONSEQUENTLY, SELLER SHALL HAVE NO LIABILITY FOR ANY PERSONAL INJURY, PROPERTY DAMAGE OR OTHER LOSS BASED ON ANY CLAIM AT ALL INCLUDING A CLAIM THE PRODUCT FAILED TO GIVE WARNING. However, if Seller is held liable whether directly or indirectly for any loss or damage with respect to the products it sells, regardless of cause or origin, its maximum liability shall not in any case exceed the purchase price of the product, which shall be fixed as liquidated damages and not as a penalty, and shall be the complete and exclusive remedy against the Seller. Should your product become defective during the warranty, please contact your installer to facilitate repair or replacement with Seller pursuant to the terms hereof. Seller reserves the right to replace any defective product under warranty with new, refurbished, or remanufactured product.

For patent information, see www.honeywell.com/patents

Ref: LCP500-L/LCP500-LC



800-18078 11/15 Rev. D

Honeywell

2 Corporate Center Drive, Suite 100

P.O. Box 9040, Melville, NY 11747

Copyright © 2015 Honeywell International Inc.

www.honeywell.com/security