

# 6200 Series Full Feature Low Energy Operator

## Programming Instructions

### Onboard or Wi-Fi Smart Device



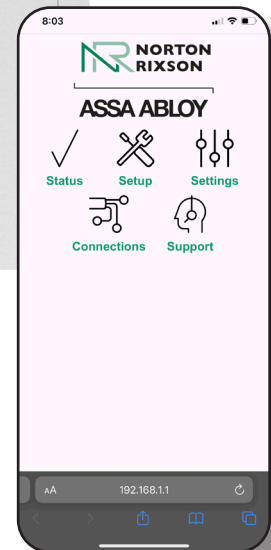
ASSA ABLOY

#### **WARNING**

This product can expose you to lead which is known to the state of California to cause cancer and birth defects or other reproductive harm. For more information go to [www.P65warnings.ca.gov](http://www.P65warnings.ca.gov).

Pour la version française voir [www.nortonrixson.com](http://www.nortonrixson.com).

READ AND FOLLOW ALL INSTRUCTIONS.  
SAVE THESE INSTRUCTIONS.



These programming instructions guide setup of the 6200 operator via the control board or a Wi-Fi smart device.

## Contents

Initial Setup .....	3
Setup Using Control Board .....	4
Setup Using Wi-Fi.....	6
Input Connections .....	11
Output Connections .....	11
Error Codes .....	12

## Wiring Diagrams

Wave to Open Wiring Diagram .....	13
Standard Activation Wiring Diagram .....	14
24VDC Fail Secure Electric Strike Wiring Diagram.....	15
RF Wiring Diagram .....	16
782 Controller x Solenoid Exit Device Wiring Diagram.....	17

### FCC:

#### Class B Equipment

This equipment has been tested and found to comply with the limits for a Class B digital device, pursuant to Part 15 of the FCC Rules. These limits are designed to provide reasonable protection against harmful interference in a residential installation. This equipment generates, uses and can radiate radio frequency energy and, if not installed and used in accordance with the instructions, may cause harmful interference to radio communications. However, there is no guarantee that interference will not occur in a particular installation. If this equipment does cause harmful interference to radio or television reception, which can be determined by turning the equipment off and on, the user is encouraged to try to correct the interference by one or more of the following measures:

- Reorient or relocate the receiving antenna.
- Increase the separation between the equipment and receiver.
- Connect the equipment into an outlet on a circuit different from that to which the receiver is connected.
- Consult the dealer or an experienced radio/TV technician for help.

This device complies with Part 15 of the FCC Rules. Operation is subject to the following two conditions: (1) This device may not cause harmful interference, and (2) this device must accept any interference received, including interference that may cause undesired operation.

### Warning:

Changes or modifications to this device may void the user's authority to operate the equipment.

### Industry Canada:

This Class A digital apparatus meets all requirements of the Canadian Interference Causing Equipment Regulations.

Cet appareillage numérique de la classe A répond à toutes les exigences de l'interférence canadienne causant des règlements d'équipement.

### Declaración de México:

La operación de este equipo está sujeta a las siguientes dos condiciones: (1) es posible que este equipo o dispositivo no cause interferencia perjudicial y (2) este equipo o dispositivo debe aceptar cualquier interferencia, incluyendo la que pueda causar su operación no deseada.

## Initial Setup

1. With building power feed turned off, route 120VAC wiring through conduit hole in backplate. (Figure 1)
2. Connect 120VAC power to power supply: HOT to "L", NEUTRAL to "N", GROUND to Ground. (Figure 1)
3. Use supplied green connectors to wire in any devices needing outputs, such as electric strikes. (Figure 2) See Input Connections and Output Connections on page 11 for information.
4. Turn on building power feed. Press and hold Factory Reset button until all LEDs are lit then release. (Figure 2)

**NOTE:** After Factory Reset, on control board there should be one solid red LED for POWER and one white LED that flashes every 1.5 - 2 seconds for STATUS. CLOSE button of Setup Buttons should be flashing orange continuously. (Figure 2)

**NOTE:** If red LED is flashing, refer to Troubleshooting section of this manual or contact Technical Product Support.

5. Confirm ON/OFF/HO switch is in the ON position. (Figure 3)

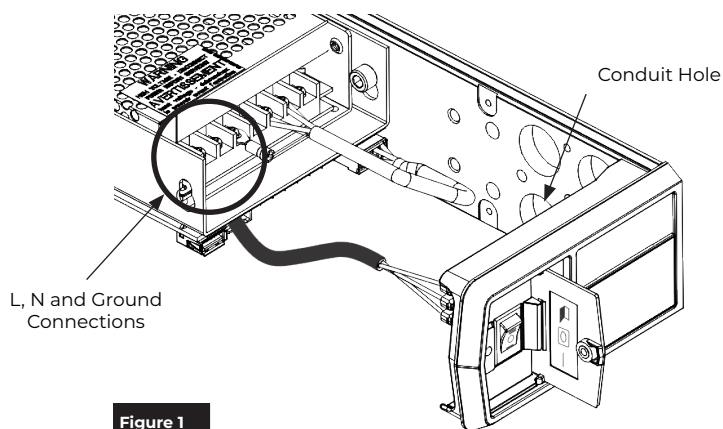


Figure 1

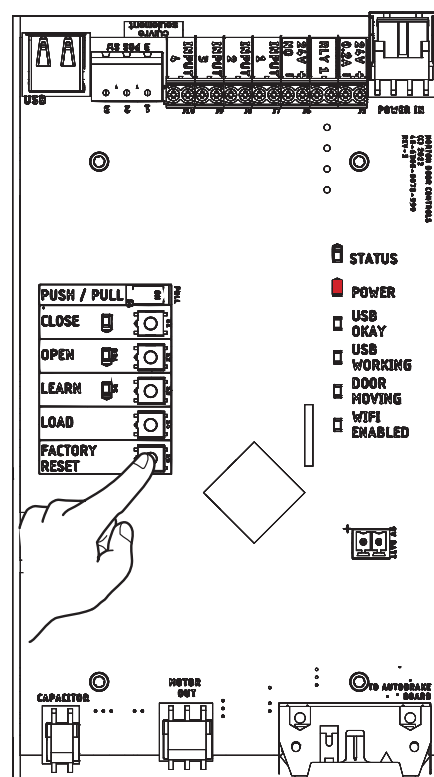


Figure 2

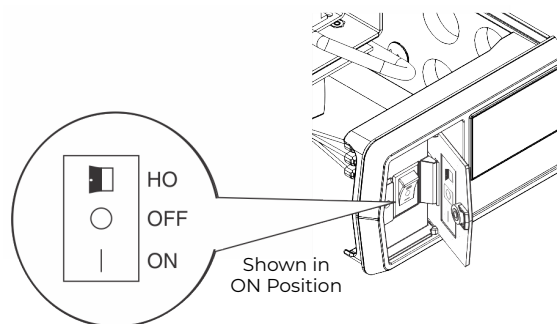


Figure 3

## Setup Using Control Board

### Select arm type.

- Depending on your application, select PUSH or PULL by moving toggle switch LEFT or RIGHT. (Figure 4 and Figure 5)

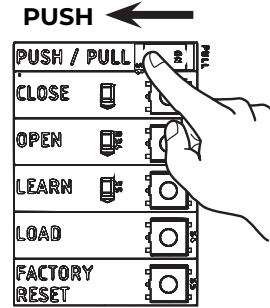


Figure 4

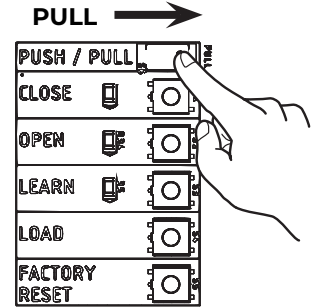


Figure 5

### Set door open and door closed positions.

- To set closed position, fully close door. Press and release CLOSE button on board. Flashing ORANGE LED should turn solid. (Figure 6)

**NOTE:** Any time door is in closed position, orange LED should be solid.

- GREEN OPEN LED should now be flashing.
- To set the fully open position, manually open door to open position and hold door there.

**NOTE:** If there is a wall or door stop at open position, hold door slightly away from wall or stop.

- Press and release OPEN button on board. Flashing GREEN OPEN LED should turn solid. Let door close. (Figure 7)

**NOTE:** Any time door is in open position, green LED should be solid.

**NOTE:** If open position is not set within 30 seconds of setting closed position, closed position must set again.

**NOTE:** Once door has fully closed, make sure there are no obstructions that could prevent door from opening. Latching hardware must not prevent door from opening during following step.

- The LEARN LED will be flashing to indicate operator must now learn its internal settings. Press and release LEARN button on board. BLUE LEARN LED will become solid and door will open in small increments. Allow door to open and close without interference. (Figure 8)

**NOTE:** After operator has learned settings, if spring is adjusted or accessories are attached to door that would make door heavier, operator MUST relearn internal settings by repeating step 5.

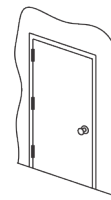


Figure 6

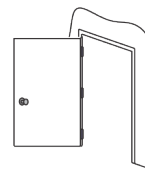
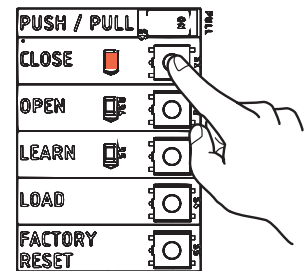


Figure 7

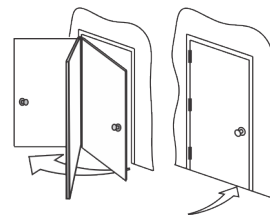
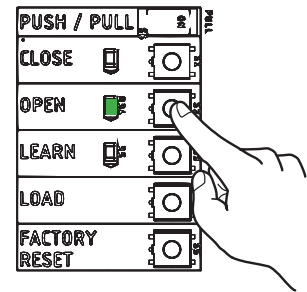
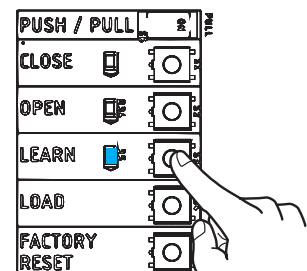


Figure 8





## Adjust opening and closing.

Use Wi-Fi programming to adjust backcheck, latch and sweep. (Figure 9)



Speed/Force and Timing/Location settings must be adjusted to meet ANSI BHMA A159.19 (American National Standard for Power Assist and Low Energy Power Operated Doors) requirements for opening and closing based on door weight and width.

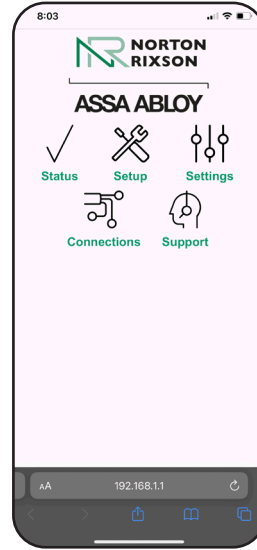
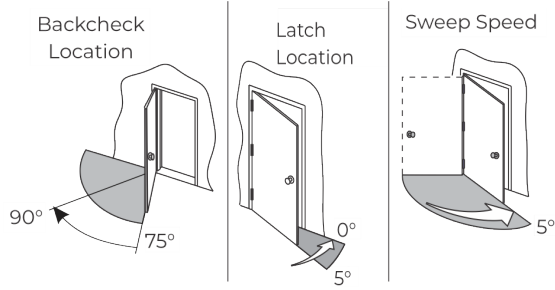


Figure 9

Continue with Input Connections on page 11

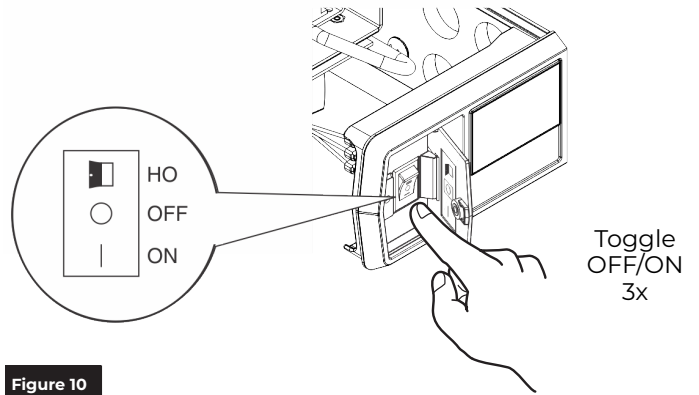
## Setup Using Wi-Fi

Follow these steps after operator has been successfully installed and power has been turned on (see Page 3, Initial Setup):

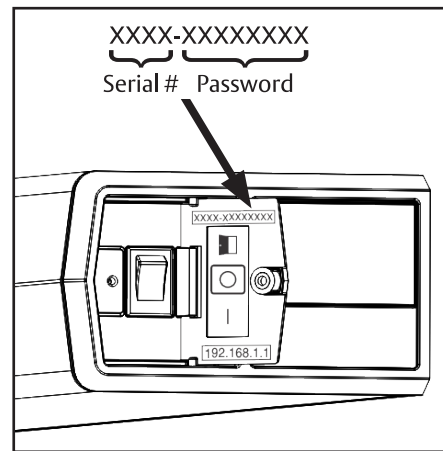
1. Turn on Operator Wi-Fi by toggling 3 Position switch on end cap 3 times. (Figure 10)

**NOTE:**

- There is a WI-FI ENABLED LED on control board to indicate Wi-Fi has been successfully turned on. However, if operator cover is attached, finding operator SSID (see step 2) is confirmation that Wi-Fi connection was successful.
  - Wi-Fi automatically turns off after 20 minutes of inactivity.
  - For further security, Wi-Fi can be turned off immediately by toggling 3 Position switch again.
  - Operator serial number, password and IP address are located inside end cap. (Figure 11)
2. From your smart device open Wi-Fi Networks to search for operator SSID. Once your specific ID beginning with NDC6200\_ is found, connect to network. (Figure 12)
  3. Enter operator password. (Figure 13)

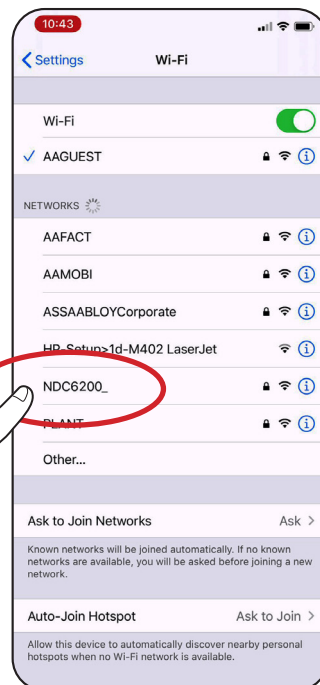


**Figure 10**



**Figure 11**

NDC6200\_ YOUR SERIAL NUMBER



**Figure 12**



**Figure 13**

- From your web browser, enter 192.168.1.1 into search bar. (Figure 14)
- The 6200 Series Operator homepage is indication of a successful connection. (Figure 15)

Enter IP: 192.168.1.1

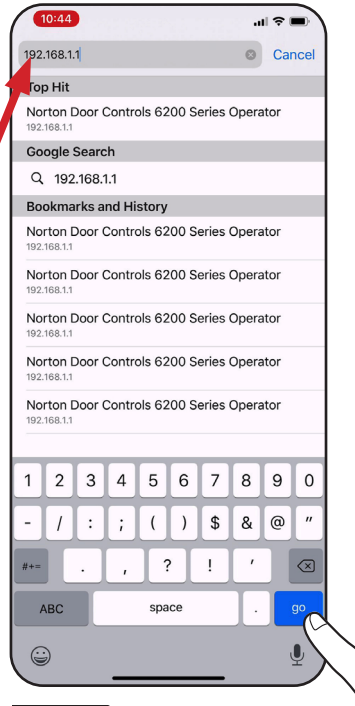


Figure 14

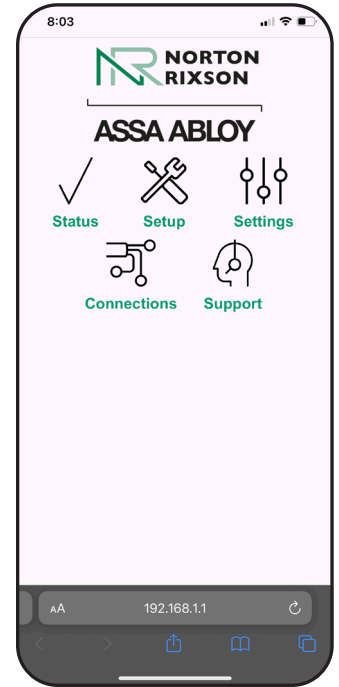


Figure 15

## Status

Use Status page to quickly access important information about your operator. (Figure 16)

**NOTE:** "Door Setup Needed" will be displayed if door setup has not been completed.

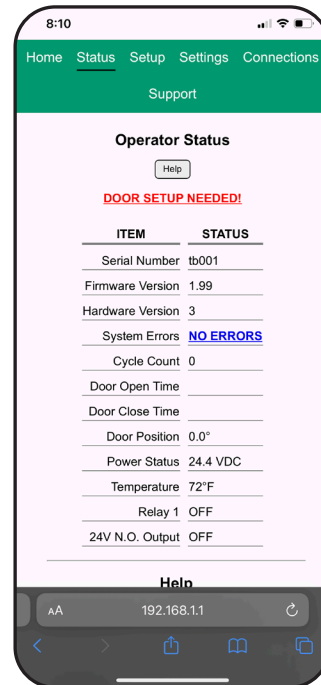


Figure 16

## Setup

To set up your operator, select Setup page and proceed through three steps. (Figure 17)

1. Manually close door and select "Set Closed Position".
2. Open door to fully open position. While holding door open, select "Set Open Position".
3. Close door completely and select "Learn" to perform Learn process.

**NOTE:** Door will automatically move through an opening cycle. Be sure there is no obstruction.

4. Refresh browser page to confirm all steps have ✓ indicating setup has been successful. (Figure 18)

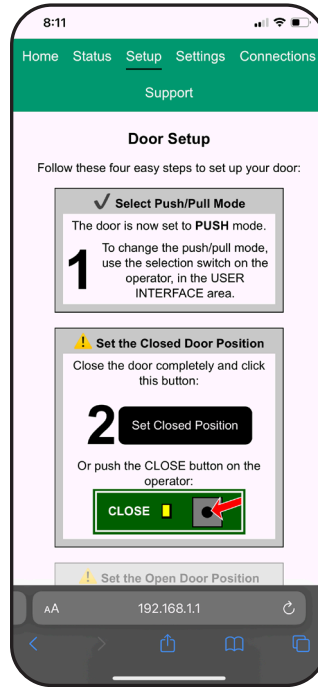


Figure 17

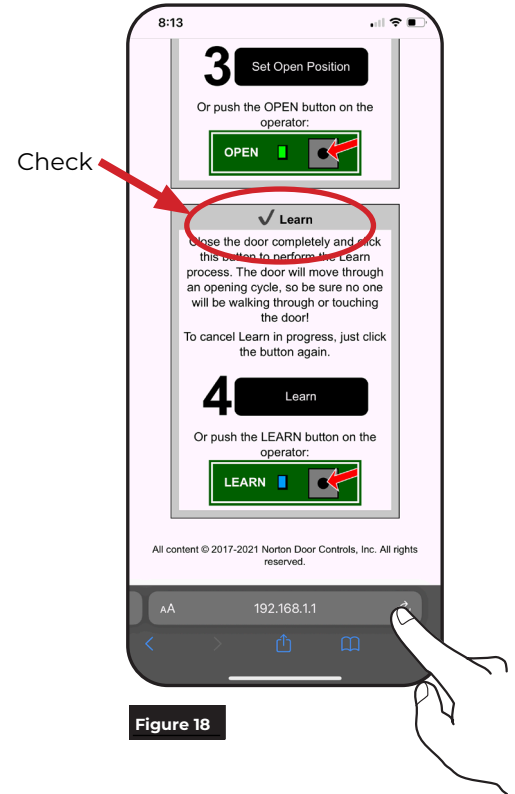


Figure 18

## Settings

**Speed/Force** (Figure 19) and **Timing/Location** (Figure 20) can be adjusted to meet BHMA requirements.

Select setting and adjust slider to desired value then save.



Speed/Force and Timing/Location settings must be adjusted to meet ANSI BHMA A159.19 (American National Standard for Power Assist and Low Energy Power Operated Doors) requirements for opening and closing based on door weight and width.

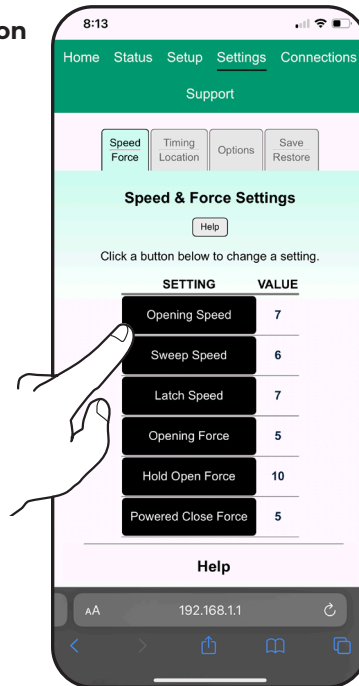


Figure 19

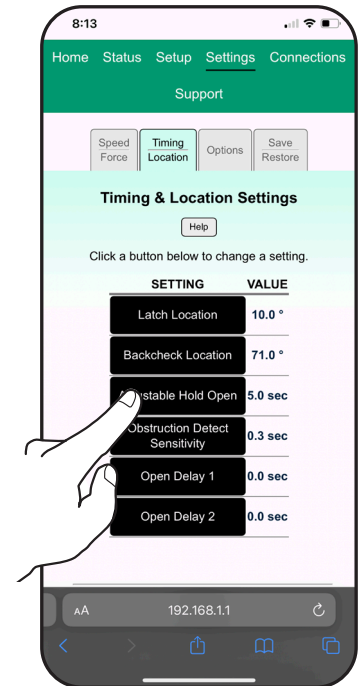


Figure 20

## Options:

Select setting and change value then save. (Figure 21)

## Save/Restore:

Use this page to transfer settings setup from one operator to another. (Figure 22)

1. Save settings to a file by selecting "Save Operator Settings to a File".
2. Connect to receiving operator's Wi-Fi.
3. Select "Select Setting file to Restore" and choose file saved in step 1.
4. Select "Restore Operator Settings from File" to load new settings.

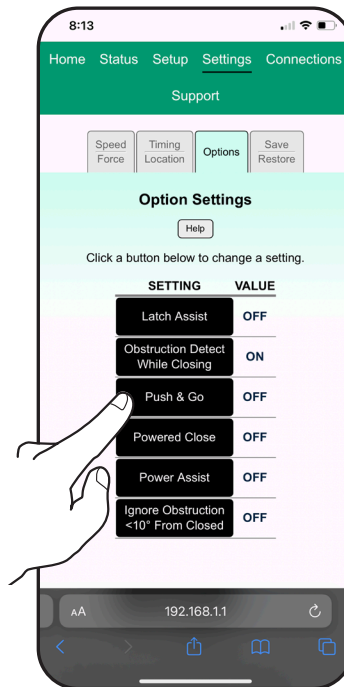


Figure 21

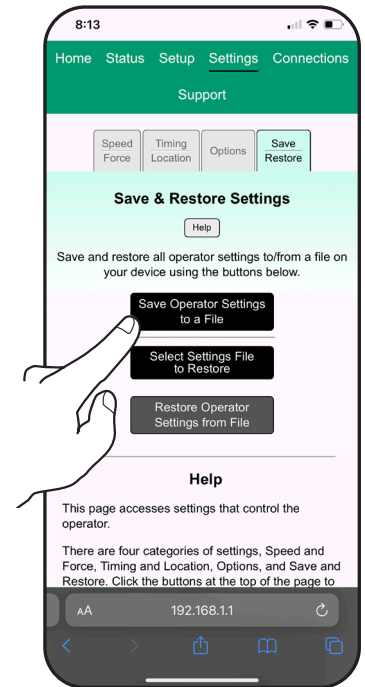


Figure 22

## Option Definitions

- **Latch Assist:** At closed position, after an activation, the door is pulled in. After the door has closed, the door is pulled in to assist with latch release/engagement.
- **Obstruction Detect While Closing:** Door will reverse to open position if it hits an obstruction while closing.
- **Push and Go:** As the door is manually opened, the operator "senses" movement and opens door to the full-open position.
- **Powered Close:** Additional force to assist door closing between 7° and 2°.
- **Power Assist:** Senses the door is being opened manually and applies small amount of power to assist user in opening the door with force less than 5 lbs. Door opens only as far as it is moved manually, then closes once released.
- **Ignore Obstruction <10° From Closed:** Used with door mounted presence sensor. Operator will ignore obstruction input from sensor in the last 10 degrees of closing.



## Connections

Operator inputs and outputs can be customized from Connections page. (Figure 23)

**NOTE:** Input and Output numbers are labeled on PCB. (Figure 26 on page 11)

To change function, select input or output then scroll through drop-down menu to select function. (Figure 24)

**NOTE:** For definitions, see Input and Output Connections. (page 11)

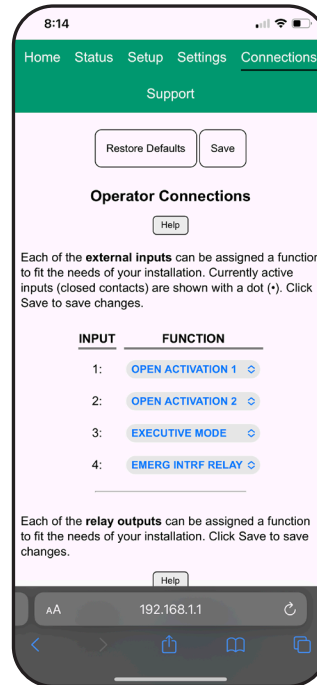


Figure 23

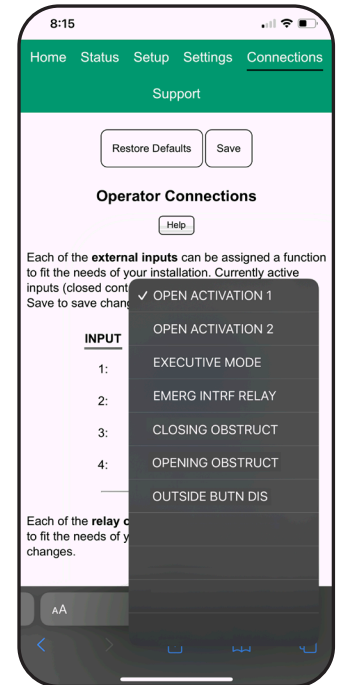


Figure 24

## Support

Support page can be used to restart or restore settings to factory defaults. (Figure 25)

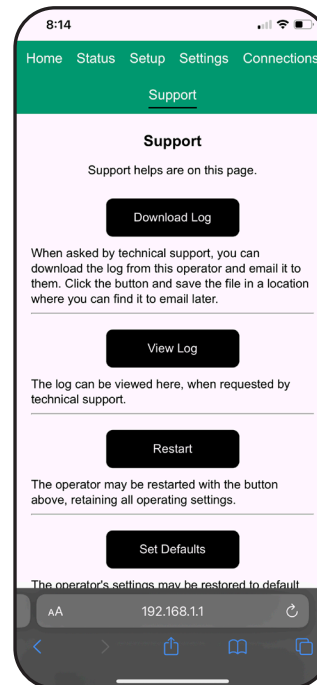


Figure 25

## Input Connections

Use green 2-position connectors on control board to add any necessary inputs. (Figure 26)

**NOTE:** Inputs can be configured to a desired setting using WiFi programming.

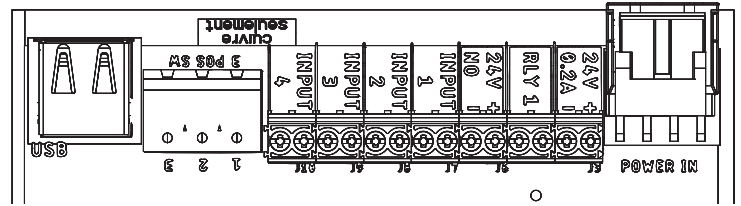


Figure 26

### Default Inputs

#### Input 1: Activation 1

Momentary contact closure of this input cycles door through an automatic open / close cycle. Tied to Open Delay 1.

#### Input 2: Activation 2

Momentary contact closure of this input cycles the door through an automatic open / close cycle. Tied to Open Delay 2.

#### Input 3: Toggle / Executive Mode

Momentary contact closure of this input sends a closed door to open position or an open door to closed position.

#### Input 4: Emergency Interface Relay

Continuous contact closure of this input puts operator in a passive closer mode, where door functions as a typical door closer and accepts no activations. Once contact is removed, unit goes back to operator mode.

### Selectable Inputs

#### Closing Obstruction

Contact closure of this input while door is open or closing triggers operator to return to open position. This is used in conjunction with presence sensors mounted to closing side of a door to prevent door from hitting an obstruction.

#### Opening Obstruction

Contact closure of this input while door is closed or opening triggers operator to stall. If contact is not removed after 10 seconds of closure, operator will return to closed position. This is used in conjunction with presence sensors mounted to opening side of a door to prevent door from hitting an obstruction.

#### Outside Button Disable

Continuous contact closure of this input triggers operator to disable Input 2 / Activation 2. This is typically used for switching off an outside wall plate.

## Output Connections

Use green 2-position connectors on control board to add any necessary outputs, such as electric strikes. (Figure 27)

**NOTE:** Relay outputs can be customized.

**Relay 1 Output:** Normally open relay that closes for 3 seconds after an activation to open.

**Normally Open:** 24VDC output up to .4 Amp draw that closes after an activation to open.

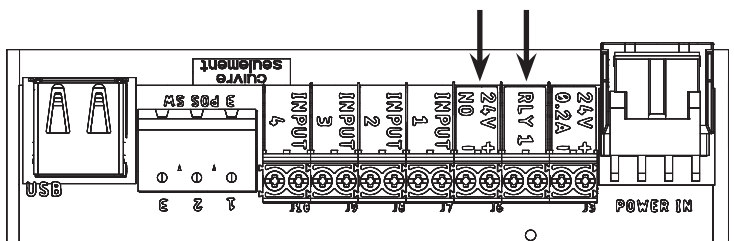
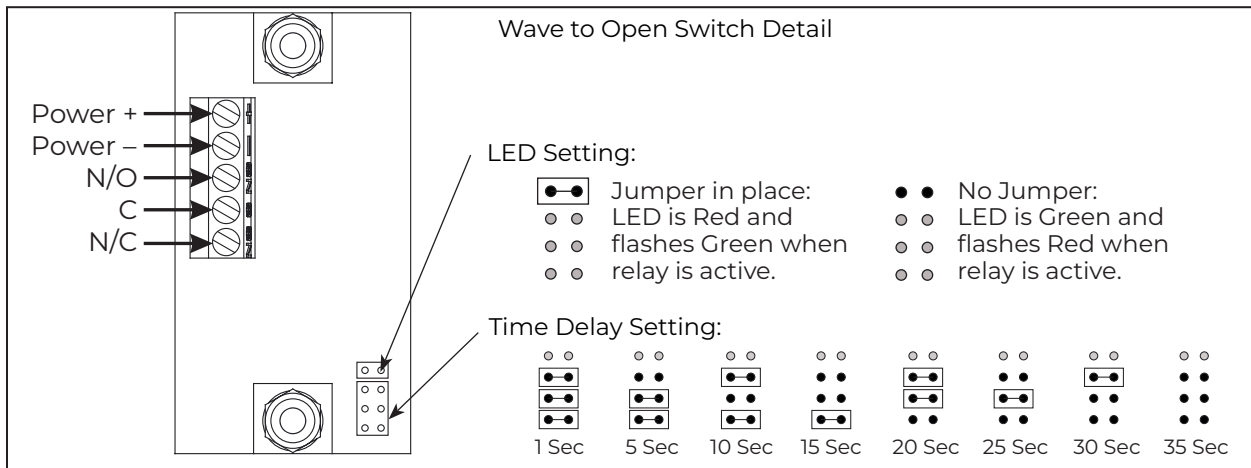
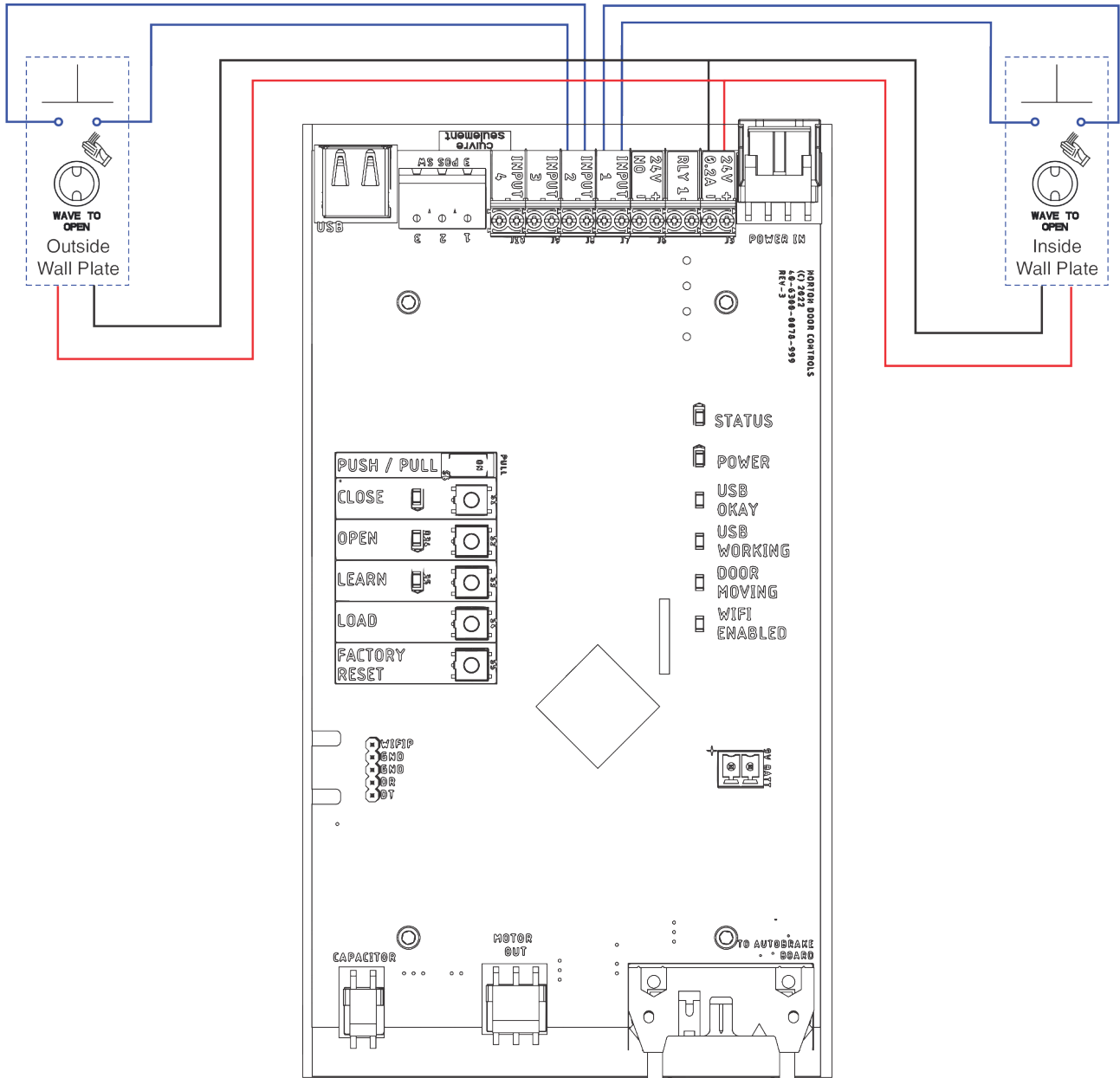


Figure 27

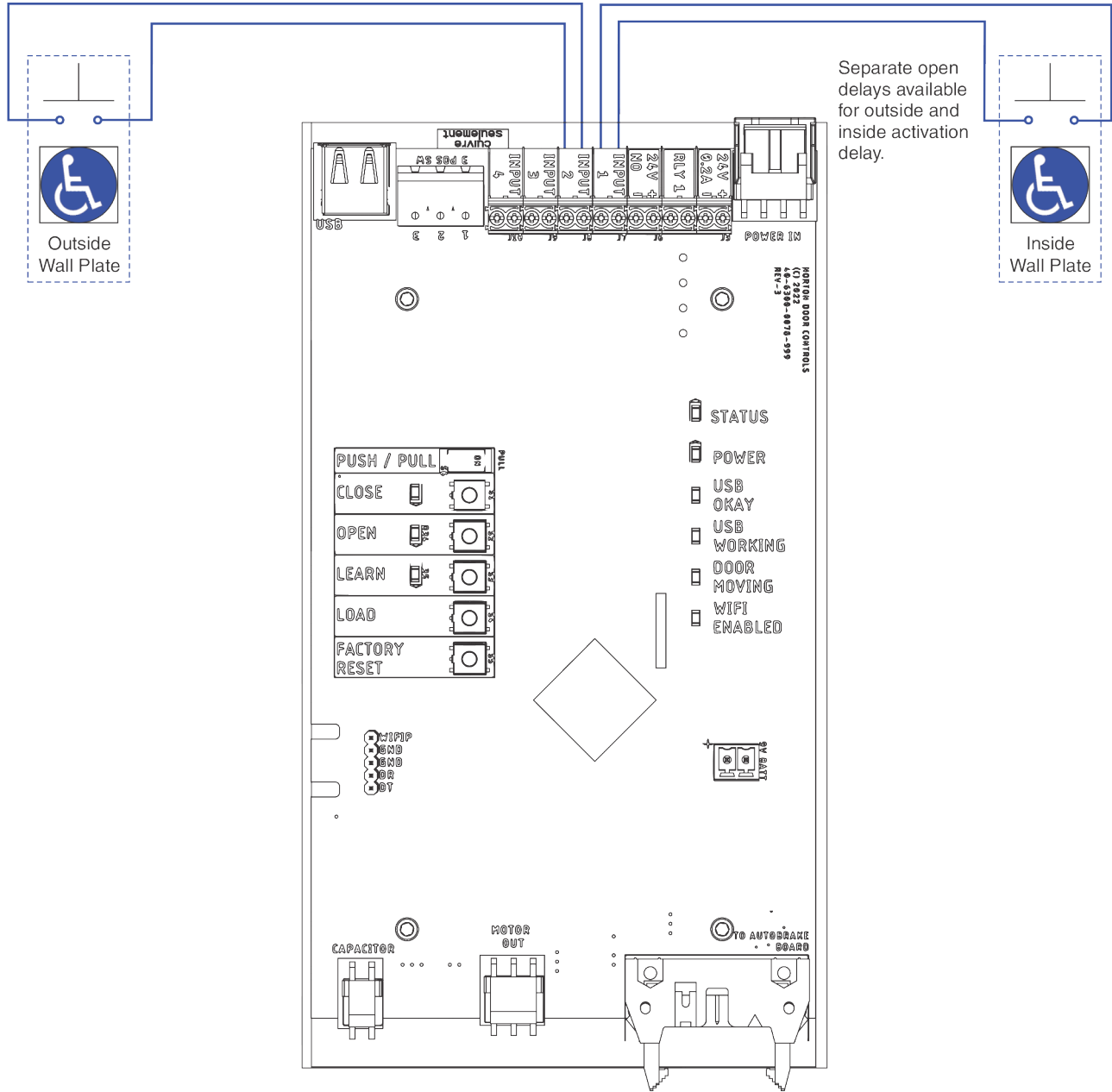
## Error Codes

Error Codes for RED POWER LED Flashes		
Number of Flashes	Cause	Solution
1	—	Reset back to factory defaults by pressing and holding POWER button until all LEDs light up then release. Unit will reset and CLOSE button will be flashing. Repeat step to set Open and Closed Positions and Learn process.
2	24VDC power error too high or too low.	Check incoming voltage to power supply and from power supply to board.
3	Error occurred during Learning process.	If door hit obstruction, reset to factory defaults by pressing and holding POWER button until all LEDs light up, then release. Repeat steps to set Open and Closed Positions and Learn process.
		If door did not hit obstruction, inspect hinges or door / frame for excessive wear, misalignment, etc. Replace worn components and repeat steps to set Open and Closed Positions and Learn.
4	—	Ensure all harnesses are plugged in and secure - focus on motor wires.
5	—	Ensure all harnesses are plugged in and secure - focus on harnesses attached to backplate.
6	—	Ensure all harnesses are plugged in and secure - focus on main board harnesses.
7	Motor overheating.	—
8	—	Ensure all harnesses are plugged in and secure - focus on harnesses attached to backplate.
9	TEMP connector not plugged in.	Plug in TEMP connector on backplate.

## Wave to Open Wiring Diagram

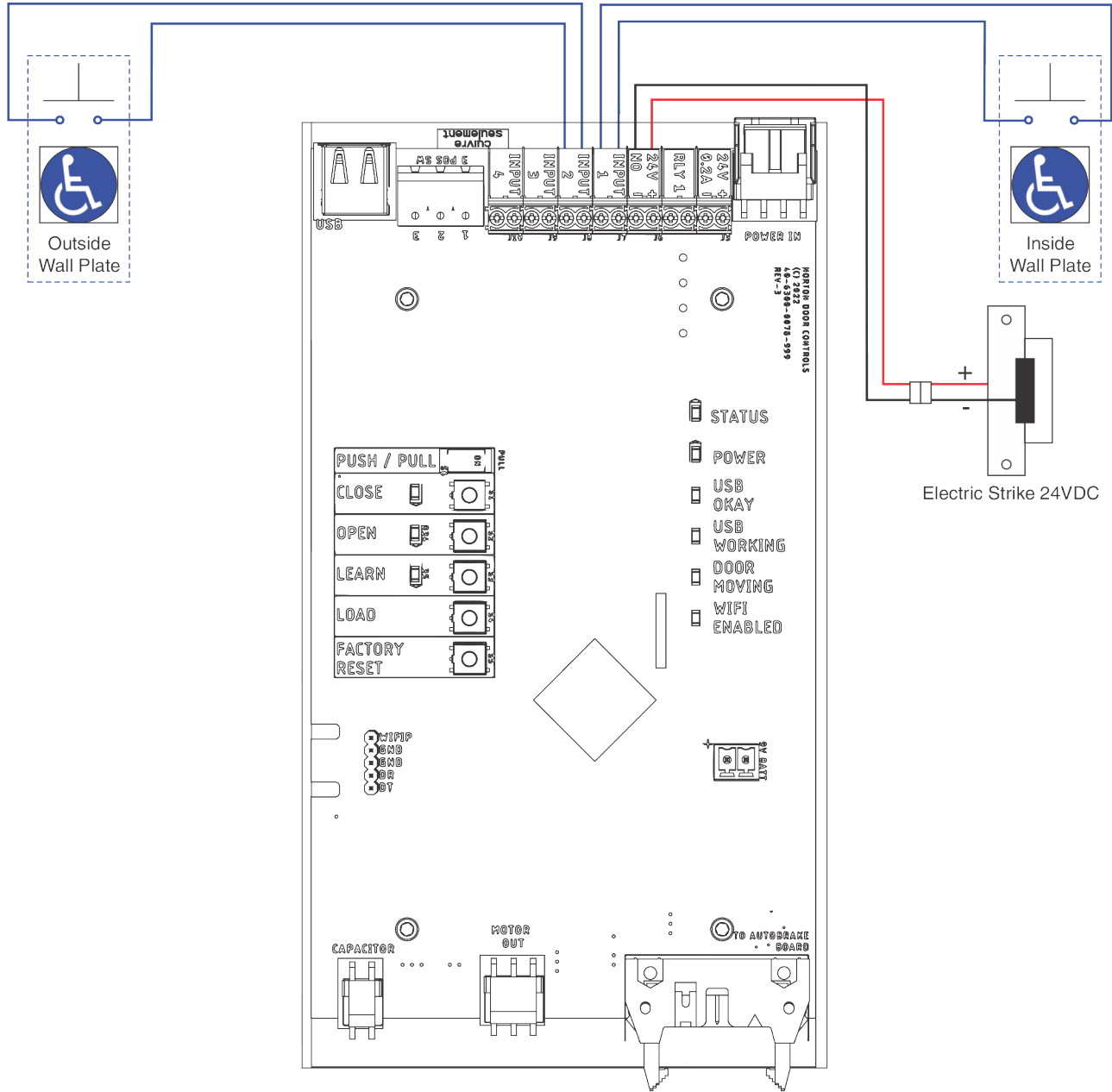


**Standard Activation Wiring Diagram**

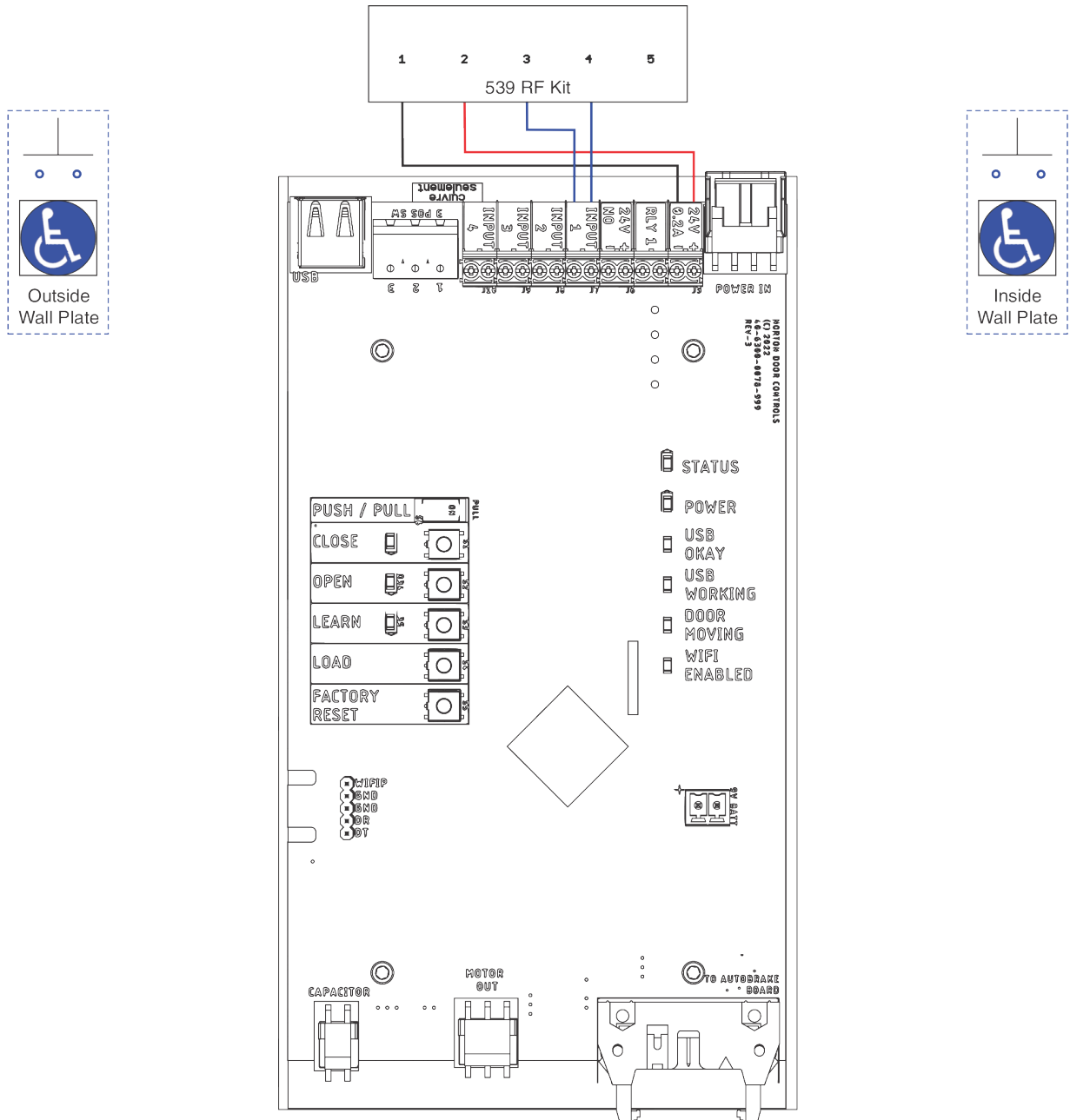




## 24VDC Fail Secure Electric Strike Wiring Diagram



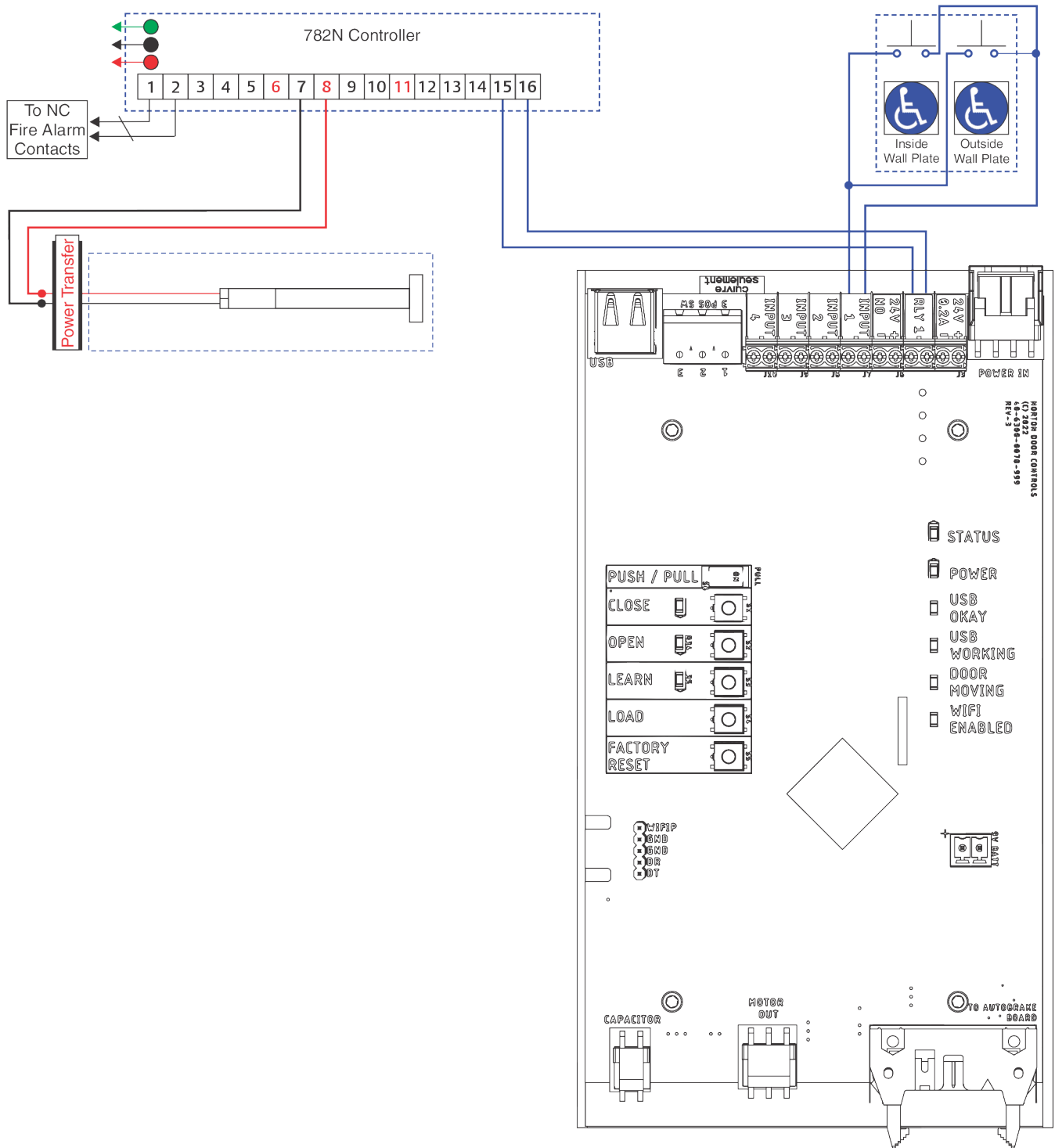
**RF Wiring Diagram**



**To install RF receiver:**

1. Position supplied hook and loop fastener onto back of receiver. Remove protective film.
2. Press receiver onto inside of end cap with green wire toward conduit hole.
3. Wire as shown above.

## 782 Controller x Solenoid Exit Device Wiring Diagram



The ASSA ABLOY Group is the global leader in access solutions. Every day we help people feel safe, secure and experience a more open world.

---



**ASSA ABLOY**

---

Technical Product Support:  
Monroe, NC 28112 USA  
Phone: 877.974.2255 ext: 2  
Techsupport.NortonRixson@assaabloy.com  
NortonRixson.com

Copyright © 2022, ASSA ABLOY Accessories and Door Controls Group, Inc. All rights reserved. Reproduction in whole or in part without the express written permission of ASSA ABLOY Accessories and Door Controls Group, Inc. is prohibited.

**Approved 2022-06-13**

80-9363-0022-020 Rev1 05/22