

D1260/D1260B



Security Systems

EN | Installation Guide
Keypads



BOSCH

Trademarks

Microsoft®, Windows®, Windows NT® are either registered trademarks or trademarks of Microsoft Corporation in the United States and/or other countries.

CYCOLOY® is a registered trademark of General Electric Company.

POLYLAC® is a registered trademark of CHI MEI Industrial Corporation, LTD.

Contents

1.0	Introduction	4
1.1	Manual Organization.....	4
1.2	Other Documentation Referenced.....	4
1.3	Documentation Conventions.....	4
1.3.1	Type Styles Used in this Manual.....	4
1.3.2	Tips, Important Notes, Cautions and Warnings.....	4
2.0	D1260/D1260B Overview	5
2.1	Parts List.....	6
2.2	Front Panel Features.....	6
2.2.1	LCD Display.....	6
2.2.2	Keypad.....	6
2.2.3	Keypad Function Keys.....	6
2.2.4	Audible Tones.....	7
2.3	Internal Features.....	8
3.0	Installation	9
3.1	Mounting.....	9
3.1.1	Location Recommendations.....	9
3.1.2	Mounting the Back Plate.....	10
3.2	Setting the DIP Switch.....	10
3.3	Tamper Switch.....	10
3.4	Volume Control.....	11
3.5	Wiring.....	11
4.0	Programming the Control Panel	12
4.1	Enabling the D1260/D1260B Keypad.....	12
4.2	Programming Area Names.....	13
4.3	Programming Security Company Information.....	13
4.3.1	D9412x, D9412 and D9112 Control Panels.....	13
4.3.2	D7412x, D7412, D7212x, and D7212 Control Panels.....	14
4.4	99 + Enter “Setup?” Function.....	14
4.5	Programming Custom Functions.....	15
4.6	Adding “Service Walk” to D7412x/D7412/D7212x/D7212 Service Menu.....	15
5.0	Specifications	17

Figures

Figure 1:	D1260/D1260B Front Panels.....	5
Figure 2:	D1260/D1260B LCD Display.....	6
Figure 3:	D1260/D1260B Keypad.....	6
Figure 4:	D1260/D1260B with Back Plate Removed.....	8
Figure 5:	D1260/D1260B Back Plate Mounting Options.....	9
Figure 6:	D1260/D1260B DIP Switch.....	10
Figure 7:	Call for Service Display.....	10
Figure 8:	Increasing and Decreasing Volume.....	11
Figure 9:	Bosch Control Panel to Keypad Flying Leads Wiring.....	11
Figure 10:	Plugging in Wire Connector to D1260/D1260B.....	11
Figure 11:	Enhanced Command Center Prompt in RPS.....	12
Figure 12:	Enable Display Revision Prompt in RPS.....	12
Figure 13:	High Brightness Settings.....	14
Figure 14:	Low Brightness Settings.....	14
Figure 15:	Contrast Settings.....	15

Tables

Table 1:	D1260/D1260B Installation Guide Organization.....	4
Table 2:	Other Referenced Documentation.....	4
Table 3:	Parts List.....	6
Table 4:	D1260/D1260B Dedicated Keys.....	6
Table 5:	Audible Tones.....	7
Table 6:	D1260/D1260B DIP Switch Settings.....	10
Table 7:	Area/Point Numbers and Area Text.....	13
Table 8:	D1260/D1260B Specifications.....	17

1.0 Introduction

This manual refers to the following control panels: B9512G, B8512G, D9412GV4, D7412GV4, D7212GV4, D9412GV3, D7412GV3, D7212GV3, D9412GV2, D7412GV2, D7212GV2, D9412G, D7412G, D7212G, D9412, D7412, D9112, and D7212. In the remainder of this manual, these control panels are referred collectively as “Bosch Control Panels.”

1.1 Manual Organization

This manual is divided into four sections:

Table 1: D1260/D1260B Installation Guide Organization	
Section	Description
1	Introduction
2	Overview
3	Installation
4	Programming the Control Panel

1.2 Other Documentation Referenced

Throughout this manual, references are made to other documentation. Refer to *Table 2* for the part numbers of the documentation that have additional information about the D1260/D1260B Keypads.

Table 2: Other Referenced Documentation	
Name of document	Part Number
<i>Security System User's Guide</i>	4998122475
<i>D7212G Program Entry Guide</i>	4998138538
<i>D7212G Program Record Sheet</i>	4998138542
<i>D9412G/D7412G Program Entry Guide</i>	47775
<i>D9412G/D7412G Program Record Sheet</i>	47488

1.3 Documentation Conventions

1.3.1 Type Styles Used in this Manual

Bold text Usually indicates selections that you can use while programming your control panel or an important fact that you should note.

Bold Italicized Denotes notes, cautions or warnings.

Italicized text Refers you to a drawing, table, another section of this document, or another document. Also used symbolizes names for records that you will create.

Courier New Text Indicates what can appear on the D1260/D1260B Keypads display.

[CAPITALIZED TEXT] Indicates a specific key to press.

Example: ...press the [ENTER] key...

Keys to press in sequence appears as [COMMAND] + [4]

File→New Describes a menu path in a Windows-based application.

Example: ...select **File→New** to create a new...

1.3.2 Tips, Important Notes, Cautions and Warnings



Important Notes - Information for successful operation and programming. Also tips and shortcuts can be included here.



Caution - These caution the operator that physical damage to the program or equipment might occur.



Warning - These warn of the possibility of physical damage to the operator.

2.0 D1260/D1260B Overview

The D1260/D1260B Keypad is a SDI Bus compatible device used with the Bosch Control Panels with versions 6.40 or higher.

The D1260/D1260B features a keypad with keys that illuminate when pressed, a four-line by 20-character display, and a built-in speaker that emits several distinct warning tones.

The control panel supplies all power and data requirements for the D1260/D1260B through a four-wire connection. Refer to the *Current Rating Chart for Standby Battery Calculations* provided in the approved applications compliance guide for the specific control panel used with the D1260/D1260B to determine if you need an additional power supply.

You can program the control panel to send messages identifying the supervised keypad that is in trouble to a central station receiver. To supervise a keypad, refer to the program entry guide specific to your control panel. If a keypad loses communication with the control panel for more than 15 sec, the keypad buzzes and Call for Service Contact us at: appears. Other keypads connected to the system show Service Keypad. The control panel transmits a serial device trouble report to the receiver. The keypad shows SDI FAILURE # if the Modem IIIa² communication format is used or TROUBLE ZN D if the BFSK communication format is used. For more information, refer to the *D6600 Computer Interface Manual* (P/N: 4998122703).

Figure 1: D1260/D1260B Front Panels

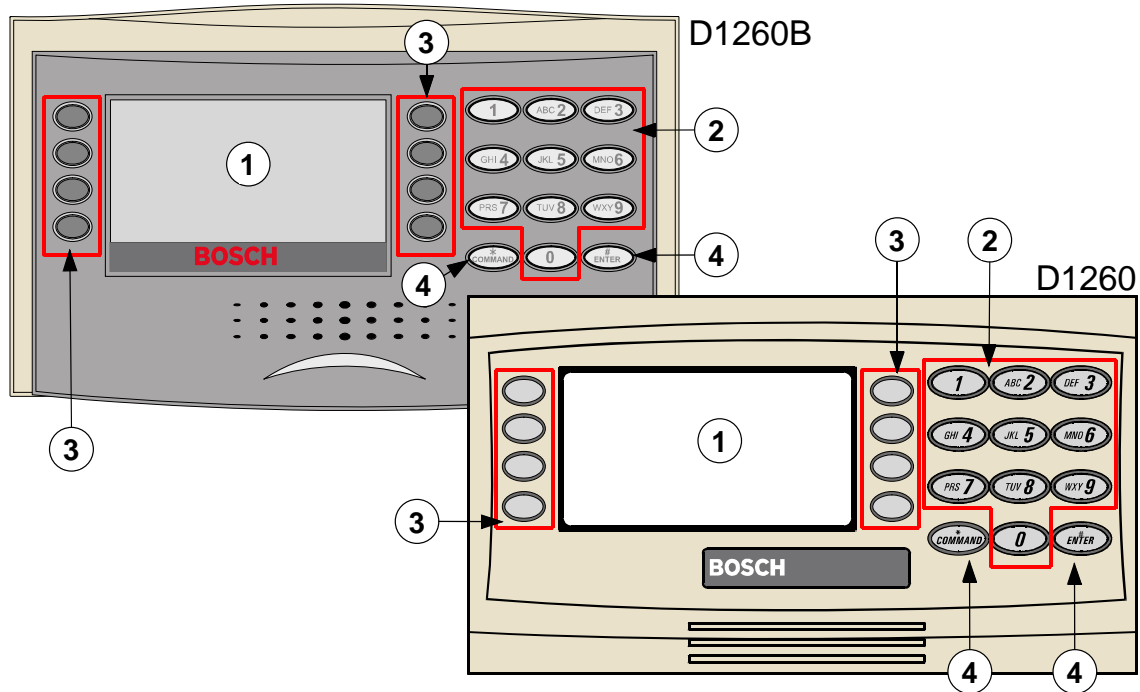

- 1 - LCD display
(refer to Section 2.2.1 LCD Display on page 6)
- 2 - Digital keypad
(refer to Section 2.2.2 Keypad on page 6)

- 3 - Soft keys (refer to Soft Keys in Section 2.2.3 Keypad Function Keys on page 6)
- 4 - Keypad function keys (refer to Section 2.2.3 Keypad Function Keys on page 6)

2.1 Parts List

Table 3 lists the items included with a D1260, D1260BLK, D1260R and D1260B Keypads.

Qty.	Description	Part Number
1	CD with: <ul style="list-style-type: none"> D1260/D1260B Owner's Manual PDF D1260/D1260B Installation Guide PDF Security System User's Guide PDF Adobe Acrobat Reader software 	4998122742B F01U036089 F01U071668 4998122475 40751C
1	Four-wire Flying Lead Connector	15-04298-000
1	D1260/D1260B Installation Guide	F01U071668
1	Security System User's Guide	4998122475
3	Wall Anchor (8-10 x 7/8)	15053
3	Screws #6x1.625PHC	47817

2.2 Front Panel Features

2.2.1 LCD Display

The D1260/D1260B Keypad displays the status of the security system using words, numbers, and symbols in its liquid crystal display (LCD). When an event occurs where the control panel is notified, the D1260/D1260B shows each event in order of its priority.



For a listing and description of the D1260/D1260B displays and command functions, refer to the *Security System User's Guide* (P/N: 4998122475).

2.2.2 Keypad

The D1260/D1260B Keypad features a digital keypad for entering user passcodes and executing system commands in the control panel.

Figure 3: D1260/D1260B Keypad

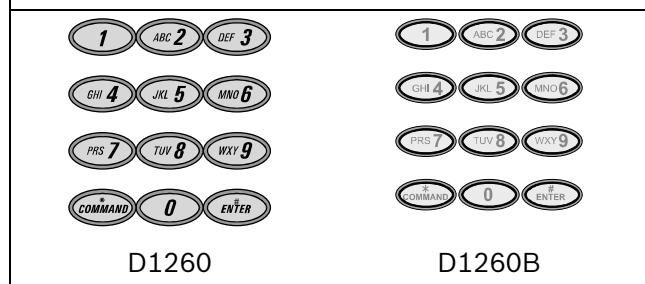

Please refer to the *Security System User's Guide* (P/N: 4998122475) for instructions on operating the system.

When a key is pressed, the D1260/D1260B emits a muted beep tone (refer to *Section 2.2.4 Audible Tones* on page 7) to indicate that the entry was accepted. The keypad lights and remains lit for 20 sec.

2.2.3 Keypad Function Keys

The D1260/D1260B has ten numeric keys, two dedicated keys (Table 4) and eight soft keys, for controlling your system.

Key	Picture		Description
	D1260	D1260B	
COMMAND			Use the [COMMAND] key in combination with one or two numeric keys to perform a function.
ENTER			Use the [ENTER] key to complete the entry of your passcode at the keypad.

Soft Keys

There are eight “soft” keys, four on either side of the display (*Item 3 in Figure 1* on page 5), for accessing menu functions. They are called soft keys because, unlike the [COMMAND] and [ENTER] keys that have a defined function, they do different actions depending on the command or function accessed.

When a selection is available, an arrow (< or >) appears next to the key. To select the function, simply press the key next to it.

2.2.4 Audible Tones

The D1260/D1260B Keypad has a built-in speaker that produces several distinct warning tones. The user can change the speaker volume and display brightness to meet their needs. You cannot connect external annunciation devices to the D1260/D1260B. Anytime the D1260/D1260B emits an audible tone, the keypad illuminates.

Silence the audible tones in *Table 5* by entering a programmed passcode with the appropriate authority, or [COMMAND] + [4] unless otherwise noted.

Tone	Description
Fire Signal	When an area is in fire alarm, the keypad emits a pulsed, high-pitched bell tone.
Burglary Signal	When an area is in alarm, the keypad emits a steady, high-pitched bell tone.
Entrance Warning	The keypad emits an intermittent beep tone during entry delay periods to remind the user to disarm the area. This is a programmable option.
Exit Warning	The keypad emits an intermittent beep tone during exit delay. This is a programmable option.
Invalid Key Buzz	When an invalid key, or sequence of keys, is pressed, the keypad emits a flat buzz tone.
Keypad Encoding Tone	The keypad emits a muted beep tone as each key is pressed to indicate that the entry was accepted. To disable this feature, refer to <i>Section 3.2 Setting the DIP Switch</i> on page 10.
Trouble Buzzer	When a trouble event occurs, such as a service alert, the keypad emits a two-tone warble until you enter [COMMAND] + [4].
Watch Tone	When you activate the Watch feature ([COMMAND] + [6]), a single clean tweedle tone alerts the user anytime a watch point is faulted. This option is programmable by point. To disable the Watch Feature, press [COMMAND] + [6] again.

2.3 Internal Features

To access the inside of the D1260/D1260B, the back plate must be removed. Using a small flat-blade screwdriver, gently push in the two holes in the bottom of the D1260/D1260B. As the tabs are pushed in, lift the back plate away from the rest of the unit.

Figure 4: D1260/D1260B with Back Plate Removed

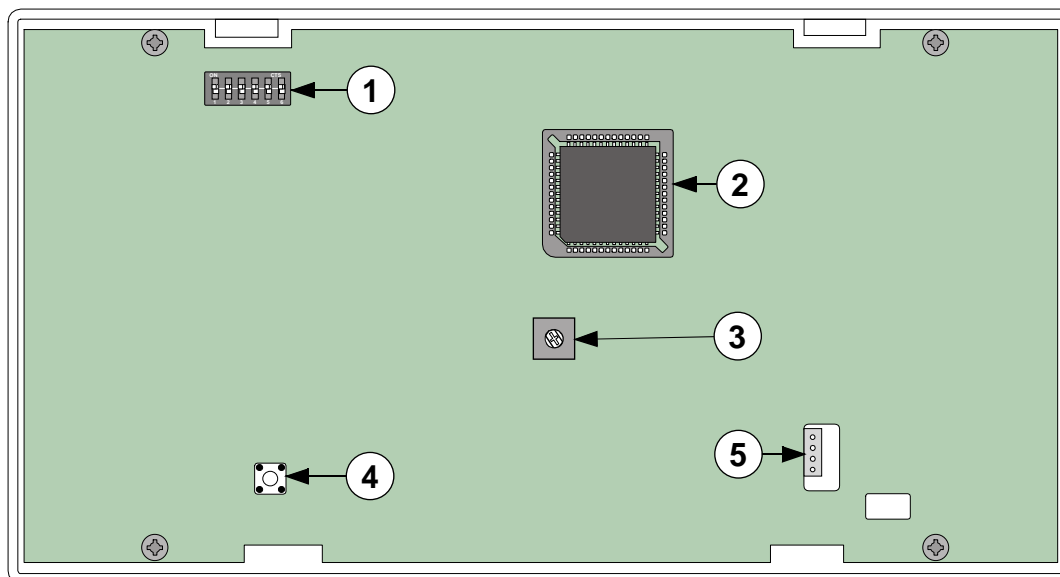

1 - DIP switch (Six-position) - allows you to select the address of each keypad, and enable/disable the keypad encoding tone. (refer to Section 3.2 Setting the DIP Switch on page 10).

2 - EEPROM socket (with example EEPROM installed)

3 - Volume control potentiometer (refer to Section 3.4 Volume Control on page 11)

4 - Wall tamper switch (refer to Section 3.3 Tamper Switch on page 10)

5- SDI connector jack

3.0 Installation

3.1 Mounting

The D1260/D1260B Keypad is a low profile, surface-mounted unit. Install the keypad using the following optional packages:

- D56 Keypad Conduit Box - Protected surface mount or flush mount
- D55 Keypad Desk Stand – Desktop
- D54B-1260 Keypad Flush Mount Kit (Brass)
- D54C-1260 Keypad Flush Mount Kit (Stainless)

3.1.1 Location Recommendations

- Do not mount the keypad in a location in direct sunlight. Direct sunlight can interfere with the D1260/D1260B display screen visibility and damage internal components.
- Do not mount the D1260/D1260B in wet or moist locations.

Figure 5: D1260/D1260B Back Plate Mounting Options

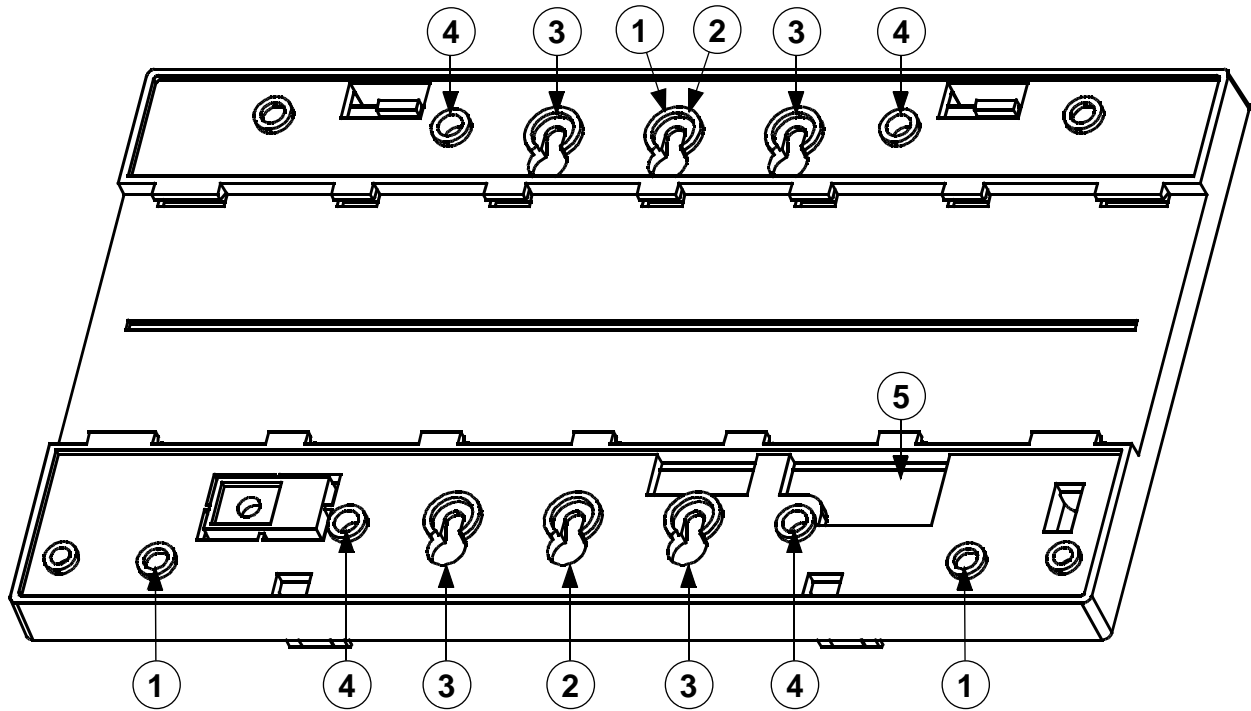

1 - Standard three-point mounting

2 - Single-gang electrical box

3 - Dual-gang electrical box

4 - Triple-gang electrical box

5 - SDI connector jack opening

3.1.2 Mounting the Back Plate

The back plate for the D1260/D1260B keypad has a variety of mounting holes to accommodate different mounting standards. To mount correctly the back plate:

1. Remove the back plate from the D1260/D1260B by using a flat-blade screwdriver to press the two small tabs on the bottom of the D1260/D1260B.

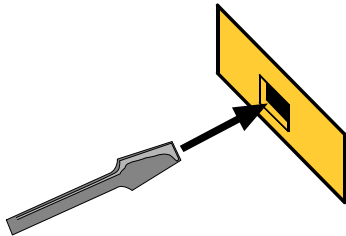

2. Lift the D1260/D1260B away from the back plate.
3. Determine the mounting method to use standard three-point, single, dual, or triple-gang electrical boxes (*Figure 5* on page 9).
4. Ensure that the back plate is right-side up. The larger portion of the single- and dual-gang mounting holes (*Items 2 and 3* in *Figure 5*) should face down.
5. Insert the four-wire flying lead (from the control panel) through the SDI connector jack (*Item 5* in *Figure 5*) at the bottom of the mounting plate.
6. Line up the mounting holes with the desired mounting method.
7. Insert the supplied screws through the appropriate mounting holes and tighten to secure the mounting plate to the wall.

3.2 Setting the DIP Switch

To access the DIP switch, remove the back cover. Switches 1 through 3 assign the address for the specific keypad.

Figure 6: D1260/D1260B DIP Switch

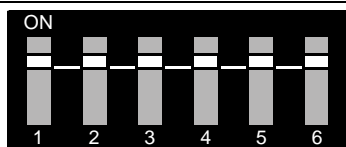

Assign each D1260/D1260B Keypad to a unique address and supervise the keypad. Switch 5 toggles the encoding tone ON and OFF. With the encoding tone turned ON, the keypad sounds a beep every time a key is pressed.

Always keep Switch 4 and 6 ON.

Table 6: D1260/D1260B DIP Switch Settings

Address #	Switch					
	1	2	3	4 ¹	5 ²	6 ¹
1	ON	ON	ON	ON	ON	ON
2	OF F	ON	ON	ON	ON	ON
3	ON	OFF	ON	ON	ON	ON
4	OF F	OFF	ON	ON	ON	ON
5	ON	ON	OFF	ON	ON	ON
6	OF F	ON	OFF	ON	ON	ON
7	ON	OFF	OFF	ON	ON	ON
8	OF F	OFF	OFF	ON	ON	ON

¹ Always set this to the On position, ² Encoding Tone On/Off

3.3 Tamper Switch

The tamper switch, when activated, signals the keypad to send a message to the control panel. Regardless of whether the control panel supervises the keypad or not, if the keypad's tamper switch activates *Figure 7* appears. To supervise keypads, refer to the control panel's program entry guide.

Figure 7: Call for Service Display



The tamper switch activates when someone or something pulls the D1260/D1260B away from a flat surface.

3.4 Volume Control

Use a flat-blade screwdriver to adjust the keypad tones' volume (*Item 3 in Figure 4 on page 8*).

Figure 8: Increasing and Decreasing Volume

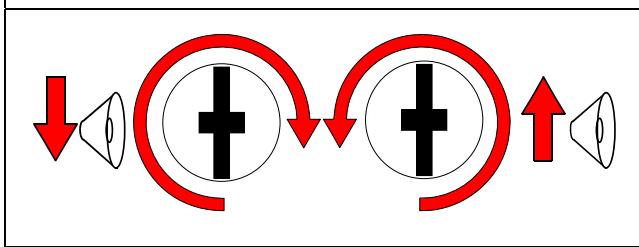

3.5 Wiring

Use a four-wire flying lead connector to connect the data and power connections between the D1260/D1260B and the control panel. The D1260/D1260B comes with a wiring assembly consisting of four color-coded flying leads and a female four-pin connector plug at one end. Wire resistance must not exceed 14 Ω.



Excessive wire resistance degrades keypad performance.

Use 18 AWG (1.2 mm) wire when connecting a D1260/D1260B to a control panel.

To connect the D1260/D1260B to the control panel:

1. Power down the control panel.
Refer to *Steps 1 and 2* in refer to *Section 3.1.2 Mounting the Back Plate* on page 10.
2. Connect the flying leads of the wiring assembly (provided) to the wires from the control panel, as shown in *Figure 9*.

Figure 9: Bosch Control Panel to Keypad Flying Leads Wiring

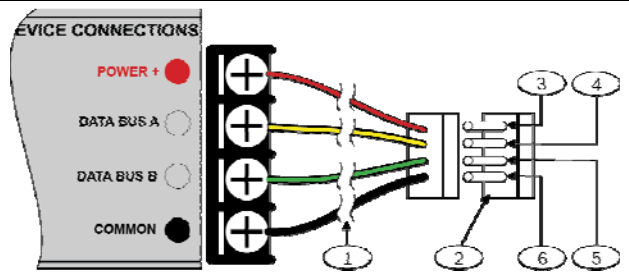

- 1 - Represents the entire length between control panel and keypad
- 2 - SDI connector jack on keypad
- 3 - SDI power
- 4 - SDI Data Bus A
- 5 - SDI Data Bus B
- 6 - SDI common

3. Turn the keypad over and plug in the wiring connector through the opening (*Item 5 in Figure 5 on page 9*) in the back of the enclosure base (*Figure 10*).

Figure 10: Plugging in Wire Connector to D1260/D1260B

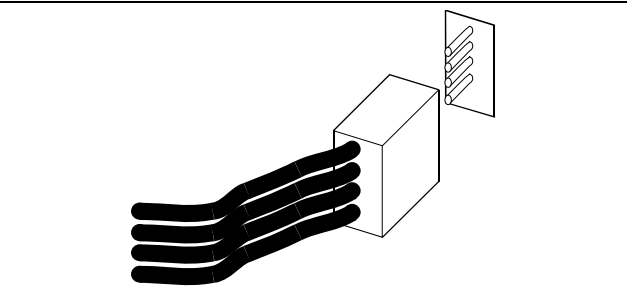

4. Replace the back plate. Align and insert the top two tabs of the enclosure into the top two tab slots of the back plate. Hold the top edges of the enclosure and back plate in position. Push the tabs inward and press the enclosure and back plate together until the cover snaps into place.

4.0 Programming the Control Panel

The D1260/D1260B Keypad is compatible with Bosch Control Panels with versions 6.40 or higher. To program the D1260/D1260B, version 3.60 or higher of remote programming software (RPS) is required.

4.1 Enabling the D1260/D1260B Keypad

1. Double-click on the RPS icon.
2. Enter a valid username and password.
3. Double-click on the desired control panel.
4. Under “D9412 Program Record Sheet” locate the section called “COMMAND CENTER (9000MAIN)”.

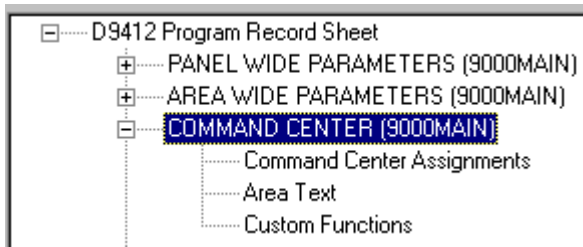

5. In the lower pane, locate **Enhanced Command Center** (Figure 11).

Figure 11: Enhanced Command Center Prompt in RPS

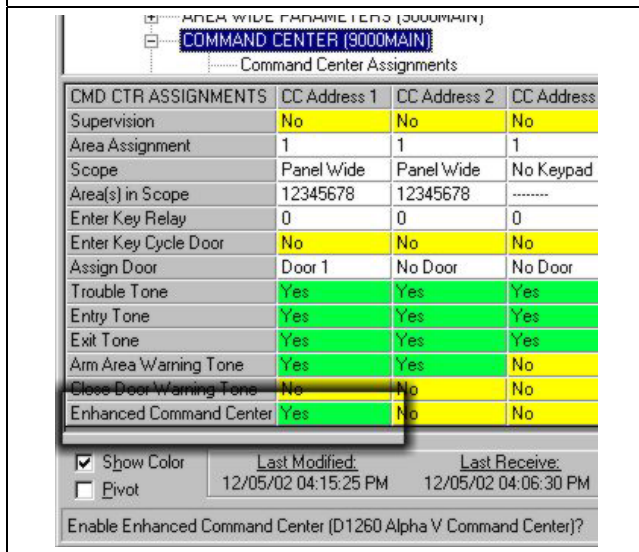

6. Change **Enhanced Command Center** for the keypad address to **Yes**.



When toggling the parameter from No to Yes, reset the control panel to ensure it takes effect.

Figure 11 assumes the keypad is CC Address 1.

For more information, refer to the control panel’s program entry guide.

7. The Display Revision (Command 59) function (under USER INTERFACE (9000MAIN) → Command Center Functions) must be enabled (E) in the control panel’s programming for the D1260/D1260B to work (Figure 12).

Figure 12: Enable Display Revision Prompt in RPS

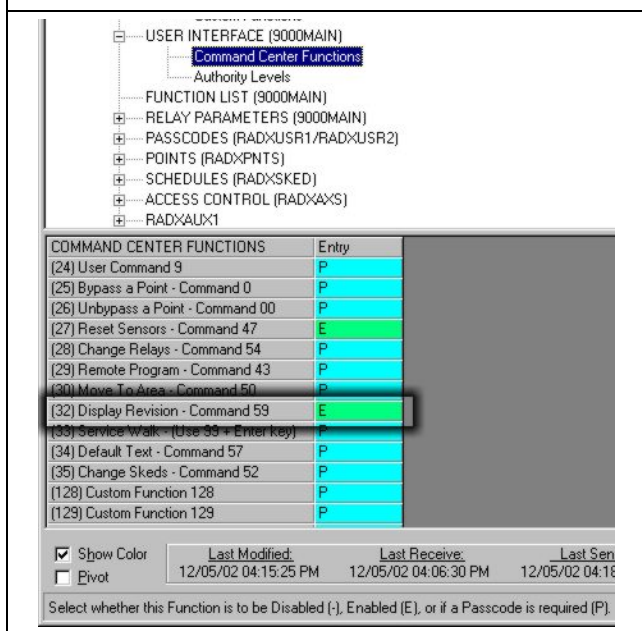

8. After completing a RPS programming session, but before exiting RPS, reset the control panel by clicking the Reset control panel checkbox before clicking OK.

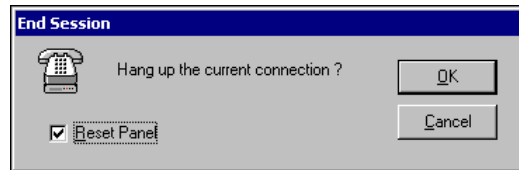

- If the control panel is not reset, the keypad shows Incorrect Panel program settings...“Enhanced CMD CTR” should be set to YES.

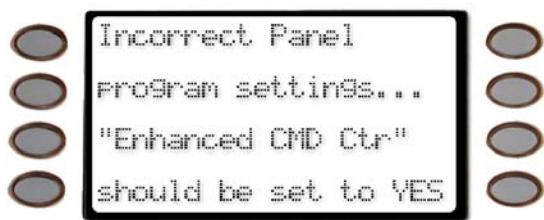

4.2 Programming Area Names

When the D1260/D1260B is installed with a B9512G, B8512G, or D9412GV4/D7412GV4/D7212GV4 (firmware version 2.00 or greater) control panel, the Area Name is entered in the Area Name parameters.

When the D1260/D1260B is installed with older Bosch Control Panels, Points 240 to 247 are used for the Area Text Name for the Area (1 to 8) that the keypad is assigned to.

When the D1260/D1260B is installed with the D7212x Control Panel, Points 240 to 243 can be used for Area Text Name for the Area (1 to 4) that the keypad is assigned to.

Points 240 to 247 can still be used in D9412 and D9112 systems to detect alarms, although any custom point text that is point specific is displayed as the Area Name Text.

For example, if a D1260/D1260B is assigned to Area 1, and the name of Area 1 is “WAREHOUSE,” then you would program the word “WAREHOUSE” into Point 240.

Refer to *Table 7* for Area Name Text assignments. This point text is used in the Bosch Control Panels to program the Area Names.

Table 7: Area/Point Numbers and Area Text

Area #	Pt #	Area Name Text – up to 16 characters
1*	240	-----
2*	241	-----
3*	242	-----
4*	243	-----
5	244	-----
6	245	-----
7	246	-----
8	247	-----

*D7212G uses Points 240 to 243 for Area Name Text.

4.3 Programming Security Company Information

Select Security Co. Info from the D1260/D1260B’s Help? menu to enter your security company’s phone number in case a subscriber needs to contact you.

4.3.1 D9412x, D9412 and D9112 Control Panels

If the keypad is connected to the D9412x, D9412, or D9112 Control Panel, use the following steps to program your security company’s name and phone number.

- Double-click on the RPS icon.
- Enter a valid username and password.
- Double-click on the desired control panel.
- Under “D9412 Program Record Sheet” locate the section called “PASSCODES (RADXUSR1/RADXUSR2)”.

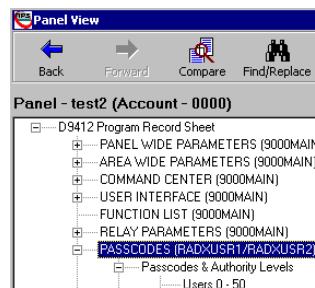

- Under Passcodes & Authority Levels, select Users 201 - 249.

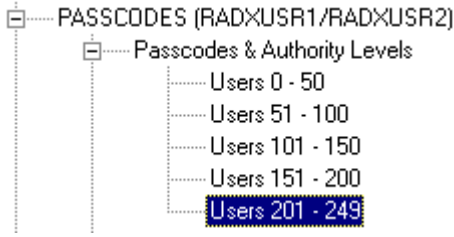

- Scroll down the rows of Users to row User 249.

Users 201 - 249	User Name
User 239	USER 239
User 240	USER 240
User 241	USER 241
User 242	USER 242
User 243	USER 243
User 244	USER 244
User 245	USER 245
User 246	USER 246
User 247	USER 247
User 248	USER 248
User 249	USER 249

- Double-click on the User 249 cell.
A dialog box appears asking to change the text USER 249.

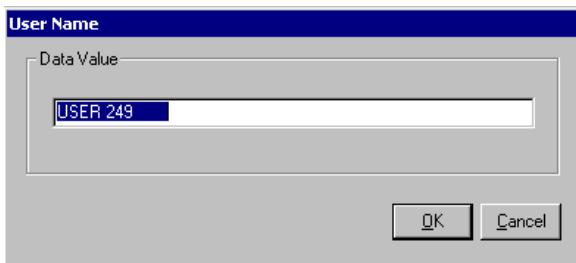

- Type the phone number of the security company.
- Click OK to finish.

The new number appears in the cell for User 249.

User 248	USER 248
User 249	1-800-555-1212

- Click the **Connect** icon to connect to the control panel.
- Select **Send RPS Data to Panel** to send the changes to the control panel.
- Click OK to start the transfer.

The Send to panel dialog box appears with an animation of blue dots moving from the PC icon to the panel icon. The updating is complete when both progress bars are full and the words "Synchronization complete" appear.

The control panel is updated with the security company's phone number.

4.3.2 D7412x, D7412, D7212x, and D7212 Control Panels

Follow the same steps in *Section 4.3.1 D9412x, D9412 and D9112 Control Panels* on page 13, except in *Step 5*, use User 99 to enter the phone number.

4.4 99 + Enter "Setup?" Function

Access the Setup function by pressing [9] [9] [Enter], **Next>**, **Setup?>**.

The adjustable functions available in this menu control brightness and contrast (*Figure 13* to *Figure 15*)

Figure 13: High Brightness Settings



Figure 14: Low Brightness Settings

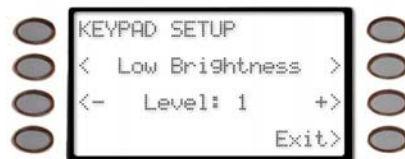
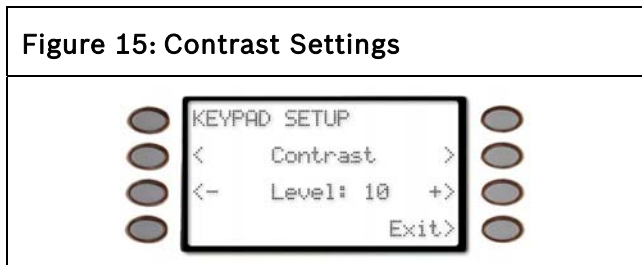
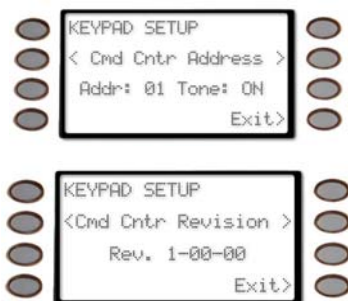

Figure 15: Contrast Settings



Each of these selections have <- Level +> soft keys on either side of the display that allows you to increase (+) or decrease (-) the setting. The High and Low Brightness are associated with Command 49's Bright Display and Dim Display settings.

This menu also shows the Keypad address, whether the Encoding Tone is On or Off, and the Keypad software revision.



4.5 Programming Custom Functions

Refer to the control panel's program entry guide for full details on how to program Custom Functions.

4.6 Adding "Service Walk" to D7412x/D7412/D7212x/D7212 Service Menu

The Service Walk function does not appear as a soft key in the Service Menu for D7412x, D7412, D7212x, D7212 control panels.

1. Double-click on the RPS icon.
2. Enter a valid username and password.
3. Double-click on the desired control panel.

4. Under "D9412 Program Record Sheet" locate the section called "USER INTERFACE (9000MAIN)."



5. Scroll down the list of commands in the lower pane to "(33) Service Walk - (Use 99 + Enter key)."

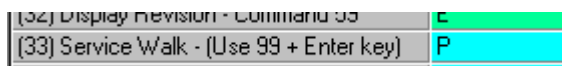

6. Double-click on the P cell.

A dialog box appears with the different settings for the Service Walk command.

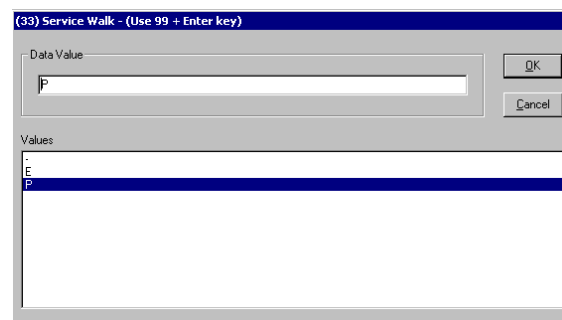

For the D7412x, D7412, and D7212x, D7212 Control Panels, the Service Walk command must be set to E (enabled) or P (password enabled) to be accessible from the D1260/D1260B Keypad.

7. Click on either E or P.
8. Click **OK**.
9. Select "FUNCTION LIST (9000MAIN)" in the D7412 Program Record Sheet.

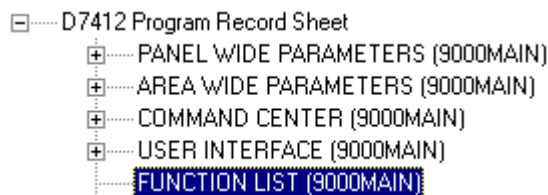

- In the pane below, scroll down the menu list to the next open Menu Item space for the keypad (assuming it is CC Address 1).

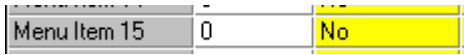

- Double-click on the **0** cell to open a dialog box to change the Function number.

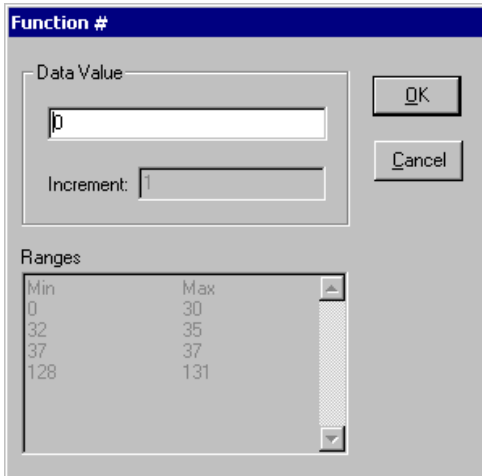

- Enter a Data Value from 0 to 33.

- Click **OK**.

Menu Item 15 is now set to Function 33 but still does not appear in the keypad menu.

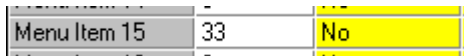

- Double-click on the yellow **No** cell to open a dialog box to change the value.

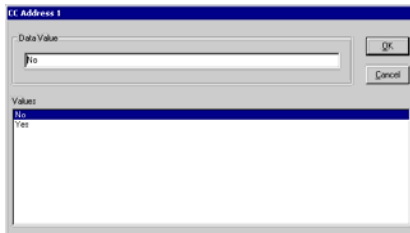

- Select **Yes** and click **OK** to exit.

A green **Yes** cell appears next to the Menu Item.

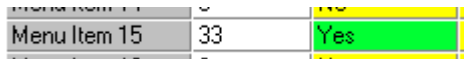

- Follow *Steps 10 to 12 in Section 4.3.1 D9412x, D9412 and D9112 Control Panels* on page 13 to update the control panel.

The Service Walk command now appears in the D1260/D1260B Keypad display.

5.0 Specifications

Table 8: D1260/D1260B Specifications				
Power Requirements	Voltage	Nominal	12 VDC	
	Standby Current	Idle	135 mA	
		Maximum*	208 mA	
		* with speaker and display backlight at maximum		
Enclosure	Dimensions	(H x W x D)		
	D1260	10.9 cm x 20 cm x 2.6 cm (4.6 in. x 8.2 in. x 0.8 in.)		
	D1260B	12.6 cm x 21 cm x 3.2 cm (5.0 in. x 8.2 in. x 1.3 in.)		
	Weight	439 g (15.5 oz.)		
	Color	D1260	Off white	
		D1260B	Off white and dark gray	
		D1260BLK	Black	
		D1260R	Red	
		D1260W	White	
	Material			
	D1260	GE CYCOLOY® CH10 UL94-HB Fire Rated		
D1260B	CHI MEI POLYLAC® PA-747 with UV Stabilizer UL94-HB Fire Rated			
Environmental	Intended for indoor use			
Temperature	Operating	0°C to +49°C (+32°F to +120°F)		
	Relative Humidity	95% + 2% @ +49°C (+120°F)		
Display	Type	Backlit LCD		
	Size	8.6 cm x 3.6 cm (3.4 in x 1.4 in) 4 lines x 20 characters		

Notes:

Notes:

Bosch Security Systems
130 Perinton Parkway
Fairport, NY 14450-9199
www.boschsecurity.com

© 2016 Bosch Security Systems
F01U071668-06



BOSCH