

# Installation/Owner's Manual

# 1601 / 1602

## Barrier Gate Operator

Use this manual for circuit board 1601-010 Revision W or higher.

1601-065-U-4-22

**THIS PRODUCT IS TO BE INSTALLED AND SERVICED BY A TRAINED GATE/DOOR SYSTEMS TECHNICIAN ONLY.**  
Visit [www.doorking.com/dealer-locator](http://www.doorking.com/dealer-locator) to find a professional installing and servicing dealer in your area.

**Read all safety instruction pages before installing and operating this product**

## AC Motor

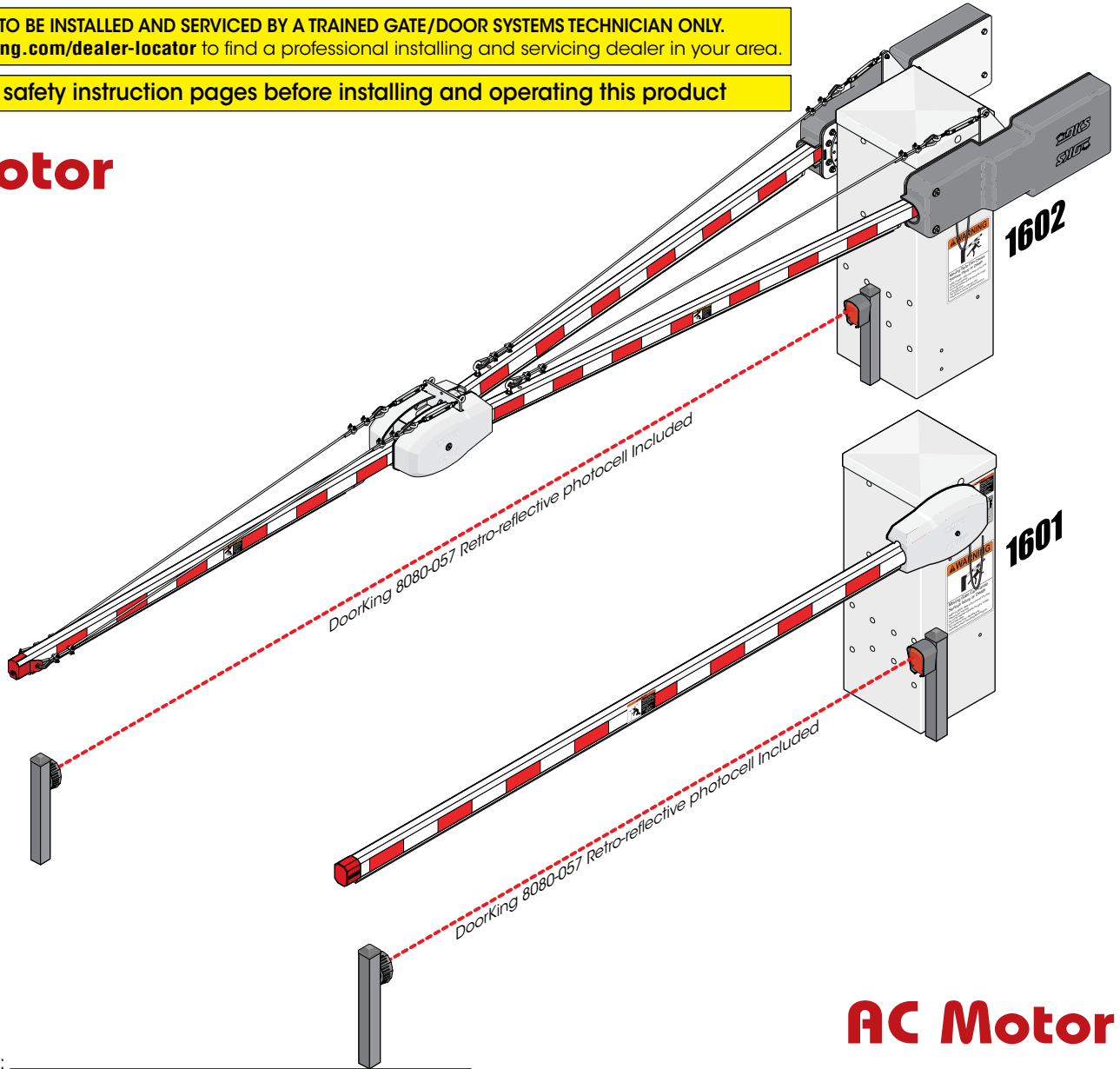

## AC Motor

Date Installed: \_\_\_\_\_

Installer/Company Name: \_\_\_\_\_

Phone Number: \_\_\_\_\_

Circuit Board  
Serial Number  
and Revision Letter: \_\_\_\_\_

**Leave Manual with Owner**

Copyright 2022 DoorKing®, Inc. All rights reserved.



Conforms To UL STD 325  
Certified To CSA STD C22.2 # 247



# UL 325 Entrapment Protection for Vertical Barrier Arm

## UL 325 Classifications



### Class I - Residential Vehicular Gate Operator

A vehicular gate operator (or system) intended for use in garages or parking areas associated with a residence of one-to four single families. This does **NOT** apply to a vertical barrier arm.



### Class III - Industrial/Limited Access Vehicular Gate Operator

A vehicular gate operator (or system) intended for use in an industrial location or building such as a factory or loading dock area or other locations not accessible by or intended to service the general public.

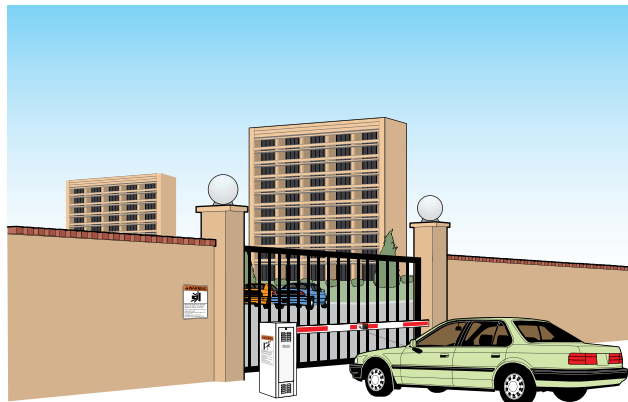

### Class II - Commercial/General Access Vehicular Gate Operator

A vehicular gate operator (or system) intended for use in a commercial location or building such as a multi-family housing unit (five or more single family units), hotel, garages, retail store, or other buildings accessible by or servicing the general public.

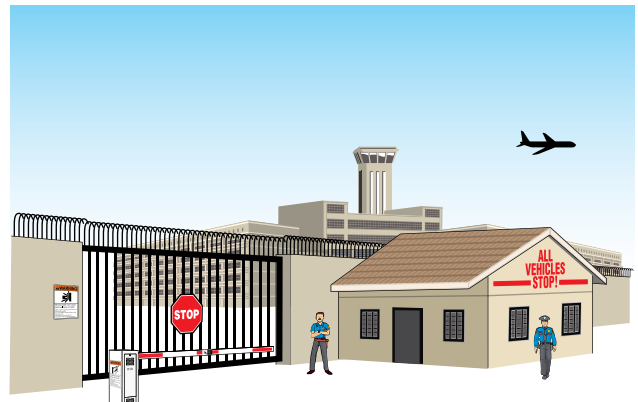

### Class IV - Restricted Access Vehicular Gate Operator

A vehicular gate operator (or system) intended for use in a guarded industrial location or building such as an airport security area or other restricted access locations not servicing the general public, in which unauthorized access is prevented via supervision by security personnel.

## Gate Operator Category

Effective January 12, 2016	Horizontal Slide, Vertical Lift, Vertical Pivot	Swing, Vertical Barrier (Arm)
<b>Entrapment Protection Types</b>	A, B1*, B2* or D	A, B1*, B2*, C or D

- Type A** - Inherent entrapment protection system.
- Type B1** - Non-contact sensor (photoelectric sensor or the equivalent).
- Type B2** - Contact sensor (edge device or equivalent).
- Type C** - Inherent force limiting, inherent adjustable clutch or inherent pressure relief device.
- Type D** - Actuating device requiring constant pressure to maintain opening or closing motion of the gate.

\* B1 and B2 means of entrapment protection must be MONITORED.

**Vertical Barrier Note:** Barrier gate operators (arm) that is not intended to move toward a rigid object closer than 16 inches (406 mm) are not required to be provided with a means of entrapment protection.

# Safety and Traffic Management for Vertical Barrier Arm

Vehicular barrier gate operators can produce high levels of force. It is important that you are aware and eliminate possible HAZARDS; Pinch Points, Entrapment Areas, Overhead Power Wires, Absence of Controlled Pedestrian Access, and Traffic Management.

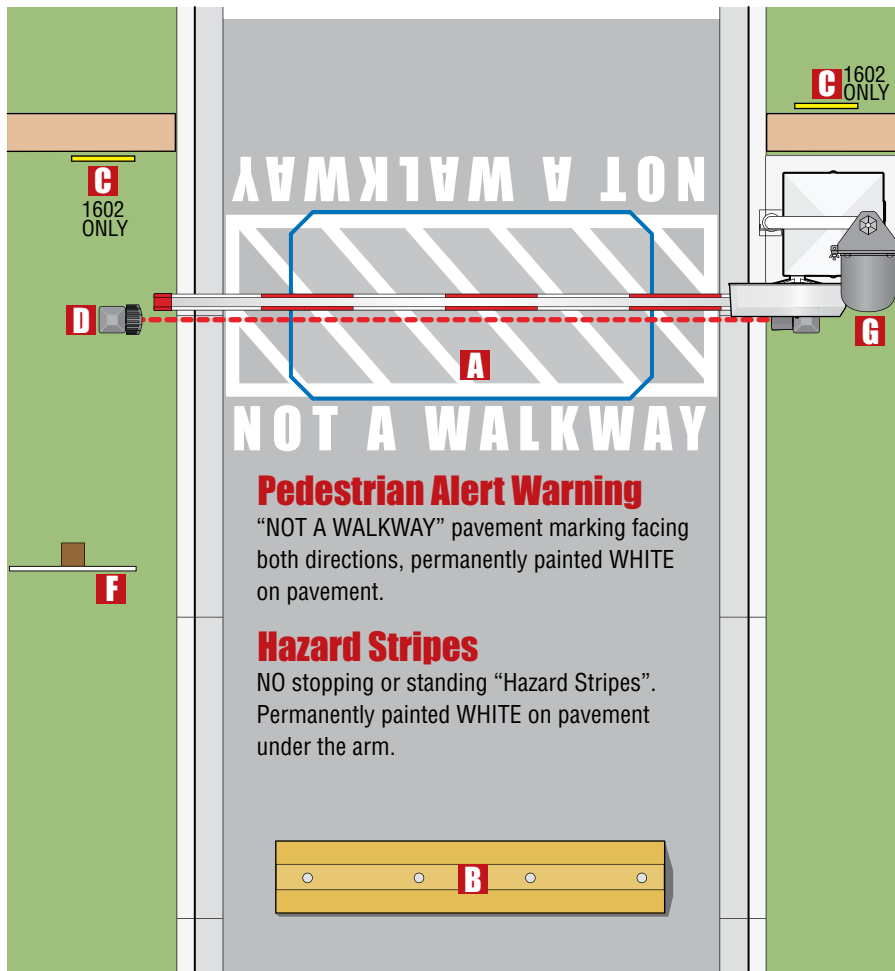

## Pedestrian Alert Warning

“NOT A WALKWAY” pavement marking facing both directions, permanently painted WHITE on pavement.

## Hazard Stripes

NO stopping or standing “Hazard Stripes”. Permanently painted WHITE on pavement under the arm.



## Separate Pedestrian Walkway

Located so pedestrians CANNOT come in contact with the barrier arm.

## A In-Ground Loop(s)

Loops minimize the potential of the arm closing when a vehicle is present. Number and placement of loop(s) is dependent on the application.

## B Speed Bump

Helps increase distance and time between vehicles.

## C Warning Signs

Permanently mounted on operator and arm and easily visible.

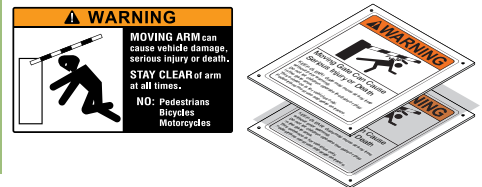

**Contact Sensor Note:** A reverse edge is **NOT** to be used as a replacement, or in lieu of, in-ground loops or non-contact sensor (photocell) that protect vehicles passing underneath the barrier arm. A **moving** vehicle coming in contact with a downward moving barrier arm **WILL** result in **damage to the vehicle** and the barrier arm/reversing edge if **NOT** using in-ground loops or non-contact sensor (Photocell).

**Note:** 2 warning signs are included with the 1602 and **MUST** be mounted on both sides of the gated area and easily visible.

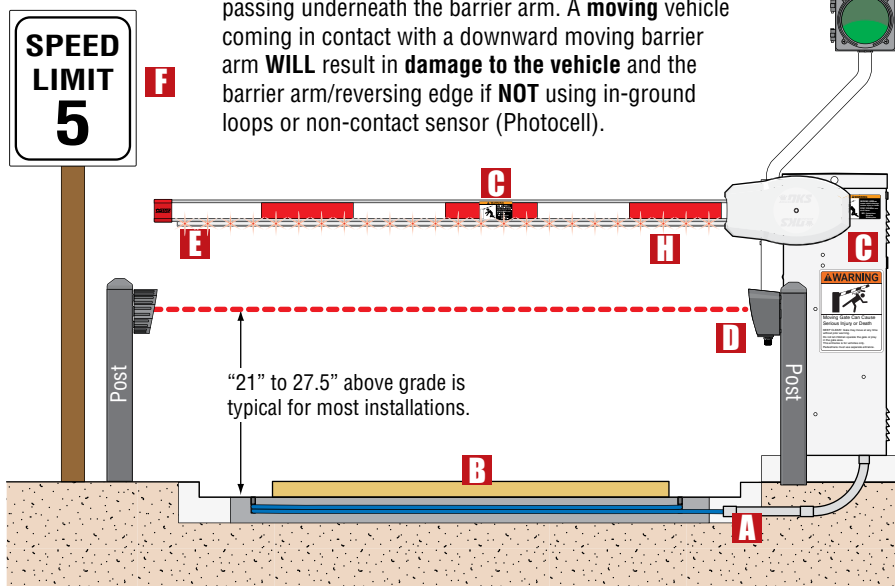

## D Non-Contact Sensor

Minimizes the potential of the arm lowering on vehicular or other traffic that loops cannot sense.

Located directly under arm.

## E Contact Sensor

Minimizes the potential of the arm lowering on vehicular or other traffic that loops cannot sense.

## F Speed Limit Sign

Helps control traffic.

## G Traffic Red/Green Light

Helps control traffic.

## H Arm LED Lights

Helps with arm's visibility and position.

# IMPORTANT Safety Information for Vertical Barrier Arm

## Reduce the risk of injury or death, read and follow all instructions.

Familiarize yourself with safety warnings, instructions, illustrations, and wiring guidelines to ensure that the installation is performed in a safe and professional manner. **Prior to installation check all local building codes and ordinances to ensure compliance.**

This scenario is **VERY DANGEROUS** and **MUST NEVER OCCUR!!**

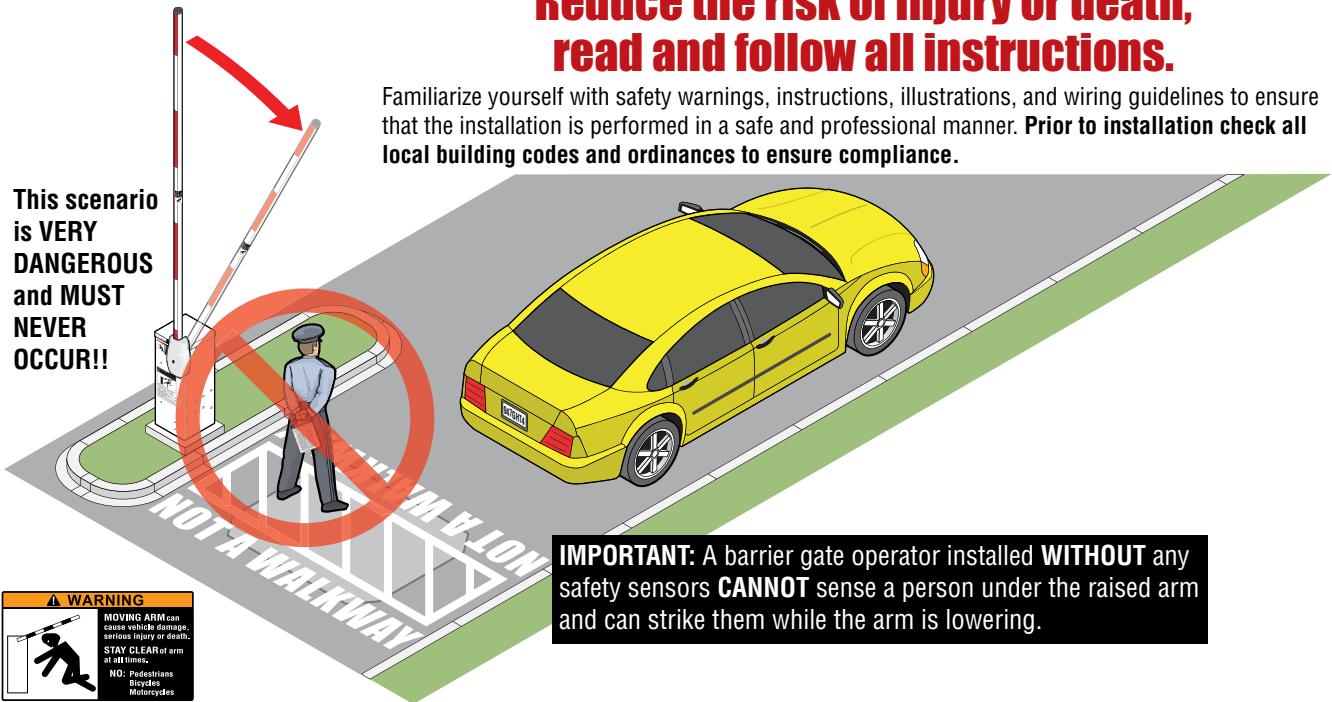

**IMPORTANT:** A barrier gate operator installed **WITHOUT** any safety sensors **CANNOT** sense a person under the raised arm and can strike them while the arm is lowering.

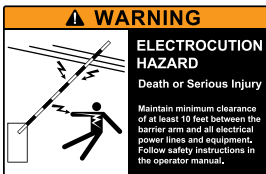
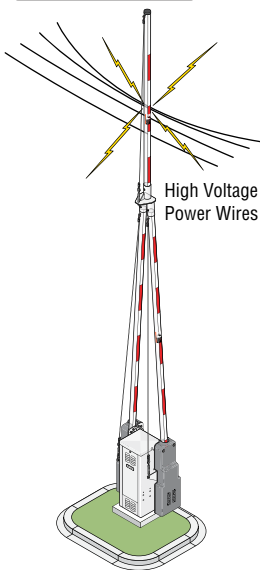

- Make sure all warning signs are on operator and arm. The 1602's two supplied warning signs **MUST** be mounted on **BOTH** sides of the gated area and easily visible.
- **Do not install the operator in such a way that the arm moves within 16 inches of a rigid object or 10 feet from high voltage power wires with arm in the raised position.**
- **Speed limit through barrier area is 5 MPH.** Install speed bumps, warning signs and hazard stripes where visible in the area of the barrier gate, failure to do so may result in injury, damage to operator and vehicle.
- Users should be familiar with proper use of operator, these include; hardware operation, reversing functions and testing, reversing loops, inherent reversing system, electric edges, photoelectric cells related external devices and possible hazards.
- **Keep adults, children and objects away from operator and HAZARD ZONES.**
- **“NOT A WALKWAY” must be painted in the roadway under the barrier arm.**
- **Pedestrians MUST be provided with a separate access opening.**
- All electrical connections should be made in accordance with local electrical codes.
- Security features should be installed to **avoid unauthorized use.**
- Controls intended for user activation must be located at least six feet (6') away from any moving part of the barrier gate and where the user is prevented from reaching over, under or around the barrier gate to operate the controls. Emergency access controls only accessible by authorized personnel (e.g., fire, police, EMS) may be placed at any location in the line-of-sight of the barrier gate.
- When **manually** operating the gate operator arm, the user **MUST** make sure that the gate area is clear **BEFORE** operating the controls. Any activity in the entrance and exit lanes should be monitored to ensure a safe operation when opening or closing the barrier gate. The motion of the barrier boom must be directly observable by the person operating the barrier. While the barrier boom is in motion **NO** pedestrian and **NO** vehicle shall be in the immediate vicinity of the barrier.
- When removing the operator lift the arm to the full open position and **shut off power at the service panel.**
- **Operators and components should be properly installed and maintained** following the recommended service schedule, test the operator monthly. Keep all debris away from operator housing vents and off of arm. Contact your service dealer for any maintenance or repairs.
- Vehicular barrier gate operators can produce high levels of force, it is important that you are aware and **eliminate possible HAZARDS; Pinch Points, Entrapment Areas, Overhead Power Wires, Absence of Controlled Pedestrian Access, Traffic Backup.**

# DoorKing Pedestrian Safety for Vertical Barrier Arm

**Reduce the risk of injury or death to a pedestrian by installing a non-contact sensor directly under the arm.**

The barrier gate operator **CANNOT** sense a pedestrian under the raised arm without installing an external safety device. To help protect against an arm lowering on a pedestrian, **install a photocell directly under the arm.**

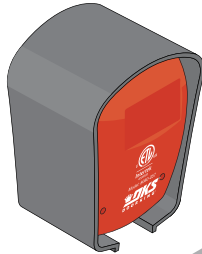

A photocell must be installed under the barrier arm to help protect pedestrians. DoorKing 8080-057 photocell is **included with the operator.**

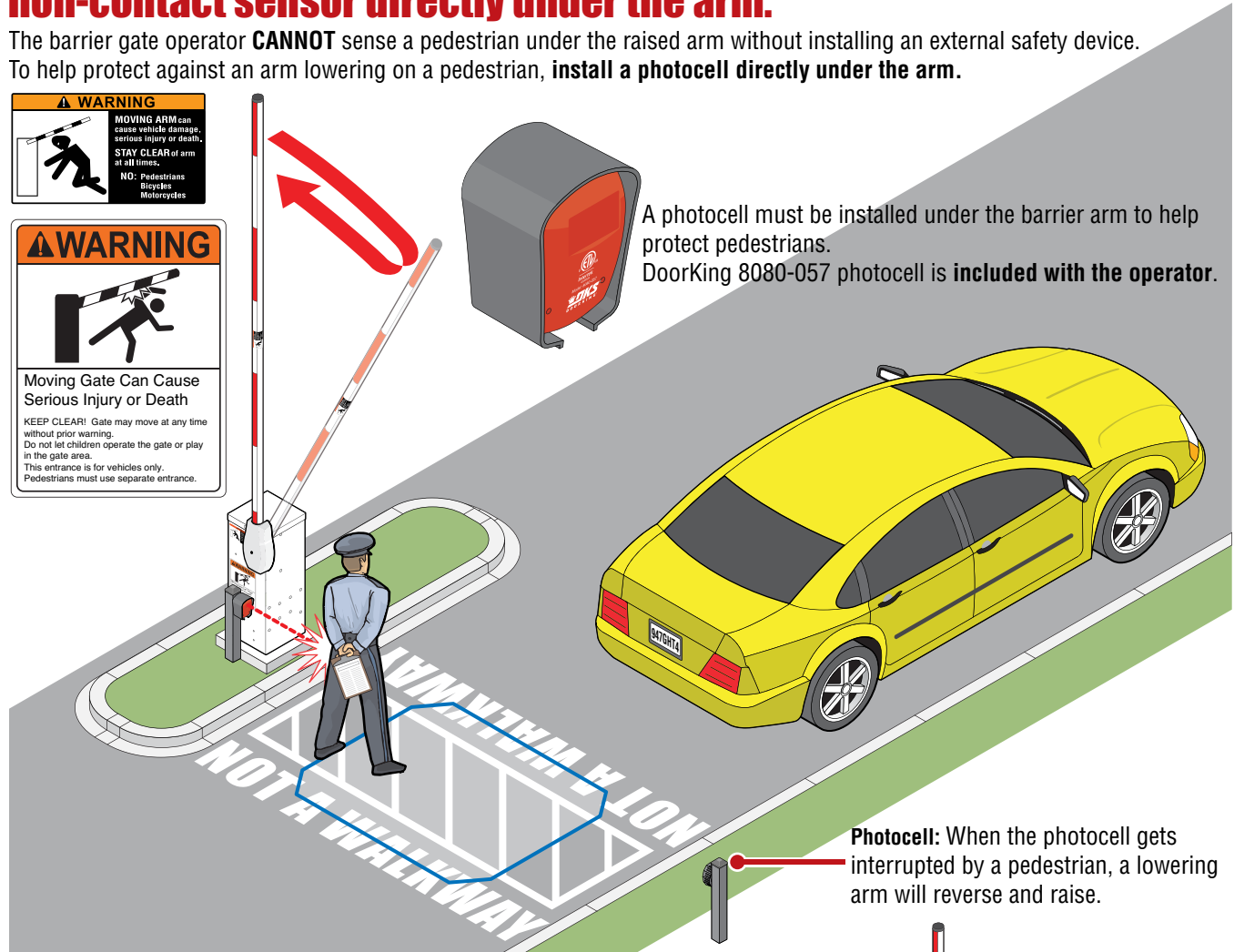

**Photocell:** When the photocell gets interrupted by a pedestrian, a lowering arm will reverse and raise.

**IMPORTANT:** A barrier gate operator installed **WITHOUT** any external safety sensors **CANNOT** sense a person under the raised arm and can strike them while the arm is lowering.

**This scenario is VERY DANGEROUS and MUST NEVER OCCUR!!**

See pages 12 through 18 for more information on how to wire the pedestrian photocell and in-ground loops.

**DO NOT Attach any External Sign on the arm.**

A lowering sign **WILL** cause damage to a vehicle or injure a person.

**This scenario is VERY DANGEROUS and MUST NEVER OCCUR!!**



# QUICK GUIDE: Terminal Descriptions



Dry Relay Contacts

## Input LEDs:

The LED that is above the terminal wiring input will light when that terminal input gets activated.

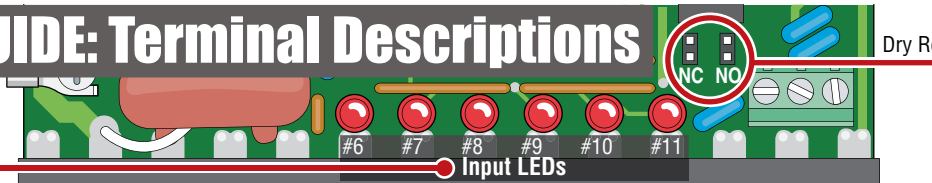

**Terminal #5 Note:**  
Exceeding 250 mA of power from this terminal may cause the circuit board transformer to overheat, causing intermittent problems.

115 VAC Motor  
115 VAC Motor  
115 VAC Motor  
115 VAC Motor  
24 VAC - 250 mA max.

**DANGER**  
HIGH VOLTAGE!

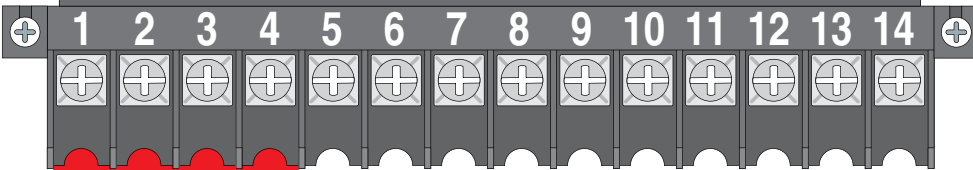

Function is dependent on the setting of programming SW 1, switch 6. When switch 6 is **OFF**, this input will cause the operator to rotate the arm to the up position. If the arm is in the down cycle, this input will reverse the arm to the up position. If this terminal has a constant input, the arm will remain in the up position regardless of any down input or timer command to rotate down. When switch 6 is **ON**, this input will cause the operator to rotate the arm to the up position when it is down, and will cause the operator to rotate the arm to the down position when it is up. If the auto timer is turned ON (Not recommended if switch 6 is ON), this input will override the timer and rotate the arm to the down position. If the arm is in the down cycle, this input will reverse the arm to the up position.



Function is dependent on the setting of programming SW 1, switch 5. When switch 5 is **OFF**, activation of the down loop will activate the relay. When switch 5 is **ON**, activation of the UP loop will activate the relay.

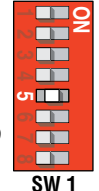

Relay contacts can be set for Normally Open (NO) or Normally Closed (NC) operation.  
**Contact rating is 1 amp maximum at 24 Volts.**

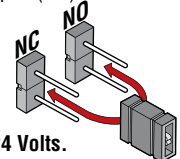

Function is dependent on the setting of programming SW 1, switch 8. When switch 8 is **ON**, the function of this input is identical to terminal 6. When switch 8 is **OFF**, this terminal becomes the logic output of the up loop detector.

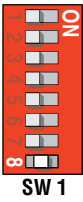

This input is used when sequencing the 1601 with a slide or swing gate operator in **PAMS** applications. This input is only active after a **MOMENTARY UP** input is received. Activation of this input will rotate the arm to the up position or reverse an arm in the down cycle to the up position.

This input is used when sequencing the 1601 with a slide or swing gate operator in **PAMS** applications. Activation of this input will rotate the arm to the up position one time, and activates the enable up input.

Function is dependent on the setting of programming SW 1, switches 1 and 4. With switch 1 **OFF** and switch 4 **ON**, activation and then deactivation of this input will rotate the arm to the down position, provided that the deactivation of the input happens while the arm is in the full up position. This input will override the auto timer if it is turned **ON**. If the arm is in the down position, traveling in the down cycle, or traveling in the up cycle, activation and deactivation of this input has no effect on the arm. With switches 1 and 4 are **ON**, activation and then deactivation of this input will rotate the arm to the down position after it reaches the full up position regardless of when the deactivation of the input occurred. When switch 4 is **OFF**, this input is identical to the reverse input, terminal 9.

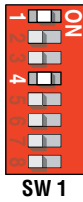

When the arm is in the down position, activation of this input has no effect. When the arm is in the up position, activation of this input will prevent the arm from rotating to the down position. If the arm is in the down cycle, activation of this input will reverse the arm to the up position. This input can be controlled to allow the arm to lower for tailgating vehicles but **NOT** get lowered when a pedestrian is underneath it. The 9411 plug-in loop detector must be installed for this function, see page 12 for more information about controlled non-contact sensors.

See pages 11 and 12 for terminal wiring.

# TABLE OF CONTENTS

<b>IMPORTANT SAFETY INFORMATION</b>	<b>Safety-1-4</b>
<b>QUICK GUIDE - TERMINAL DESCRIPTIONS</b>	<b>Quick Guide-1</b>
<b>SPECIFICATIONS FOR 1601 AND 1602</b>	<b>2-5</b>
<b>SECTION 1 - INSTALLATION</b>	<b>6</b>
1.1 Safety and Underground Conduit Requirements	6
1.2 New Concrete Pad	7
1.3 Trenching Existing Concrete	7
<b>SECTION 2 - WIRING</b>	<b>8</b>
2.1 High Voltage Wire Runs	8
2.2 High Voltage Terminal Connections	8
2.3 Dual Gate Operators (Primary/Secondary)	9
2.4 Main Terminal Description	10
2.5 Control Wiring	11-12
2.6 P.A.M.S. Multiple Gate Operator Sequencing	13
<b>SECTION 3 - LOOP DETECTOR LANE SETUPS</b>	<b>14</b>
3.1 Entry Lane Only	14
3.2 Exit Lane Only	15
3.3 2-Way Traffic Lane	16
3.4 Ticket Spitter Entry Lane	17
3.5 Operator Timer ON Entry Lane (No Down Loop)	18
<b>SECTION 4 - ARM INSTALLATION</b>	<b>19</b>
4.1 Mounting Hub(s)	19
4.2 1601 Mounting Arm	20
4.3 1602 3-Piece Arm Assemblies	20
<b>SECTION 5 - ADJUSTMENTS</b>	<b>21</b>
5.1 1601 Circuit Board Description and Adjustments	21
5.2 DIP-Switch SW 1 and SW 2 Settings	22-24
5.3 Reverse Arm UP and DOWN Positions	25
5.4 Magnetic Limit Adjustment	26
5.5 Reverse Sensor Adjustment	26
5.6 Manual Operation of the Arm	27
<b>SECTION 6 - OPTIONAL CONVENIENCE OPEN SYSTEM</b>	<b>28</b>
6.1 Circuit Board Settings and Descriptions	28
6.2 DC System Wire Schematic	29
<b>SECTION 7 - OPTIONAL ACCESSORIES</b>	<b>30</b>
7.1 1601 Contact Sensor Installation (Reversing Edge)	30
7.2 Additional Optional Accessories (LED Traffic Light, Manual Release, Fan Kit, Heater Kit)	31-32
<b>SECTION 8 - TECHNICAL INSTRUCTIONS</b>	<b>33</b>
8.1 Maintenance Schedule	33
8.2 Diagnostics Check	34
8.3 Troubleshooting	34-35
8.4 Accessories Parts List	36
Operator Wiring Schematics	37-38

# 1601 SPECIFICATIONS

Use this manual for the Model 1601 operators with circuit board 1601-010 Rev W or higher ONLY.

Type of wiring to be used on ALL external devices:  
**A) Type CL2, CL2P, CL2R, or CL2X.**  
**B) Other cable with equivalent or better electrical, mechanical, and flammability ratings.**

**Class of Operation:**

Model 1601 - UL 325 Class II, III, IV – ETL Listed

**Type of Gate:** Single Traffic Lane Vehicular Barrier Gate Only

**Arm Types:** Wood/Plastic/Aluminum – Straight or Folding Arm

**Gate Cycles:** High Cycle

**Pedestrian Protection:** Inherent entrapment sensing system (Type A)  
 Provision for connection of a non-contact sensor (Type B1) and/or contact sensor (Type B2)

Model #	Convenience Open	Horsepower - Volts	Amp	Max Arm Length	Speed 90°
White Housing					
1601-380	No	1/2 HP - 115 VAC	5.7	14 Ft.	2.5 Sec
1601-381	Yes	1/2 HP - 115 VAC	5.7	14 Ft.	2.5 Sec
Gray Housing					
1601-480	No	1/2 HP - 115 VAC	5.7	14 Ft.	2.5 Sec
1601-481	Yes	1/2 HP - 115 VAC	5.7	14 Ft.	2.5 Sec

**Note:** 208/230/460/575 VAC input voltage can be connected to the operator by installing an "Optional" High Voltage Kit (P/N 2600-266).

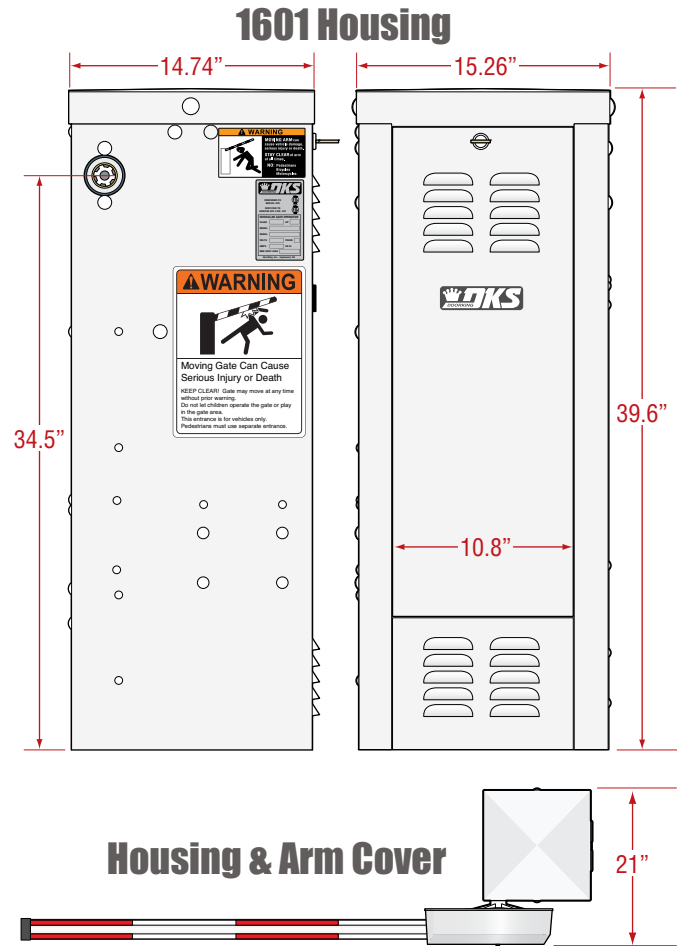

## 1601 Barrier Arm Options

(Arms shown without the plastic cover installed.)

**Plastic Arm**  
 12 Ft Plastic Arm Only P/N 1601-571  
 Plastic Arm Hardware Kit (Required) P/N 1601-241

**Plastic Folding Arm**  
 Plastic FOLDING Arm Kit (With Arm) P/N 1601-383

**Wood Arm**  
 14 Ft Wood Arm Only P/N 1601-348  
 Wood Arm Hardware Kit (Required) P/N 1601-240

**Wood Folding Arm**  
 Wood FOLDING Arm Kit (With Arm) P/N 1601-384

(Arms continued on next page.)

DoorKing, Inc. reserves the right to make changes in the products described in this manual without notice and without obligation of DoorKing, Inc. to notify any persons of any such revisions or changes. Additionally, DoorKing, Inc. makes no representations or warranties with respect to this manual. This manual is copyrighted, all rights reserved. No portion of this manual may be copied, reproduced, translated, or reduced to any electronic medium without prior written consent from DoorKing, Inc.



# 1601 BARRIER ARM OPTIONS CONTINUED

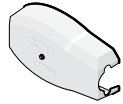
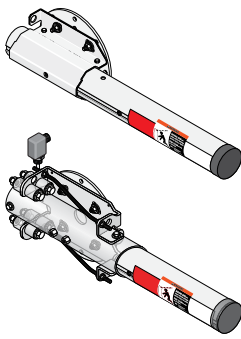

(Arms shown without the plastic cover installed.)

## Round Aluminum Arm

Choose { 14 Ft 1-Piece Aluminum Arm Only P/N 1601-516  
14 Ft 2-Piece Aluminum Arm Only P/N 1601-524  
Arm Hardware Kit (Required) P/N 1601-242

## Round Aluminum Break-Away Arm

14 Ft 1-Piece Aluminum Break-Away Arm Only P/N 1601-522  
Choose { 14 Ft 2-Piece Aluminum Break-Away Arm Only P/N 1601-528  
Break-Away Arm Hardware Kit (Required) P/N 1601-285

## Round Aluminum Folding Arm

Aluminum FOLDING Arm Kit (With Arm) P/N 1601-610

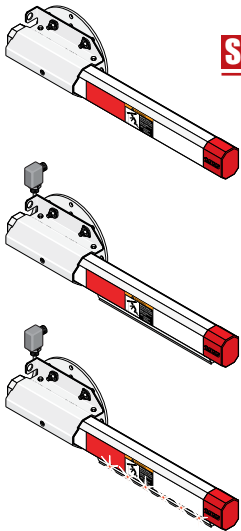

## STANDARD Bracket Octagon Arm OPTIONS

### Octagon Arm

Choose { 14 Ft 1-Piece Octagon Arm Only P/N 1601-555  
14 Ft 2-Piece Octagon Arm Only P/N 1601-567  
Arm Hardware Kit (Required) P/N 1601-242  
Rubber Bumper P/N 8080-089

### Octagon Reversing Edge Arm

Choose { 14 Ft 1-Piece Octagon Arm Only P/N 1601-555  
14 Ft 2-Piece Octagon Arm Only P/N 1601-567  
Octagon Arm Hardware Kit (Required) P/N 1601-235  
Reversing Edge (Required) P/N 8080-080

### Octagon Reversing/LED Edge Arm

Choose { 14 Ft 1-Piece Octagon Arm Only P/N 1601-555  
14 Ft 2-Piece Octagon Arm Only P/N 1601-567  
Octagon Arm Hardware Kit (Required) P/N 1601-235  
Reverse Edge + Red/Green LED (Required) P/N 8080-096

## Octagon Folding Arm

2 6Ft Folding Octagon Arms Only P/N 1601-812  
Arm Hardware Kit (Required) P/N 1601-242  
2 Reverse Edge + Red/Green LED P/N 1601-822  
Rubber Bumper P/N 8080-089

## Octagon Counterweight & 2-ft Arm Extension

Octagon Counterweight Kit P/N 1601-800  
OPTIONAL 2-ft Octagon Arm Extension P/N 1601-802  
Rubber Bumper P/N 8080-089

### 1601 2-ft Extension Notes:

- Can **ONLY** be used with the 14-ft 1-Piece Arm.
- Can **NOT** use a Reverse/LED Edge.
- Can **NOT** use a Break-Away Bracket.
- **MUST** use the Counterweight kit with 2-ft extension.

## Octagon Retrofit Kits for 1601 Operator in the Field:

Replace an existing 1601 wood/plastic/round aluminum arm to an octagon arm

### Octagon Arm Retro Kit P/N 1601-532

(For a standard octagon arm with Reverse Edge + Red/Green LED)

### Octagon Break-Away Arm Retro Kit P/N 1601-534

(For a break-away octagon arm with or without Reverse Edge + Red/Green LED)

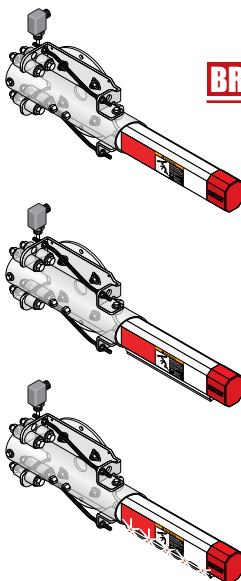

## BREAK-AWAY Bracket Octagon Arm OPTIONS

### Octagon Break-Away Arm

Choose { 14 Ft 1-Piece Octagon Arm Only P/N 1601-555  
14 Ft 2-Piece Octagon Arm Only P/N 1601-567  
Break-Away Arm Hardware Kit (Required) P/N 1601-295  
Rubber Bumper P/N 8080-089

### Octagon Break-Away Reversing Edge Arm

Choose { 14 Ft 1-Piece Octagon Arm Only P/N 1601-555  
14 Ft 2-Piece Octagon Arm Only P/N 1601-567  
Break-Away Arm Hardware Kit (Required) P/N 1601-295  
Reversing Edge (Required) P/N 8080-080

### Octagon Break-Away Reversing/LED Edge Arm

Choose { 14 Ft 1-Piece Octagon Arm Only P/N 1601-555  
14 Ft 2-Piece Octagon Arm Only P/N 1601-567  
Break-Away Arm Hardware Kit (Required) P/N 1601-295  
Reverse Edge + Red/Green LED (Required) P/N 8080-096

**Contact Sensor Note:** A reverse edge is **NOT** to be used as a replacement, or in lieu of, in-ground loops or non-contact sensor (photocell) that protect vehicles passing underneath the barrier arm. A **moving** vehicle coming in contact with a downward moving barrier arm **WILL** result in **damage to the vehicle** and the barrier arm/reversing edge if **NOT** using in-ground loops or non-contact sensor (Photocell).

# 1602 SPECIFICATIONS

Use this manual for the Model 1602 operators with circuit board 1601-010 Rev W or higher ONLY.

## Class of Operation

Model 1602 - UL 325 Class II, III, IV – ETL Listed

## Type of Gate

Wide Traffic Lane Vehicular Barrier Gate Only

## Arm Types

Wood/Aluminum 3-piece counter-balanced assembly

## Gate Cycles

Low Cycle

## Pedestrian Protection

Inherent entrapment sensing system (Type A)

Provision for connection of a non-contact sensor (Type B1) and/or contact sensor (Type B2)

Type of wiring to be used on ALL external devices:

A) Type CL2, CL2P, CL2R, or CL2X.

B) Other cable with equivalent or better electrical, mechanical, and flammability ratings.

## 1602 Housing

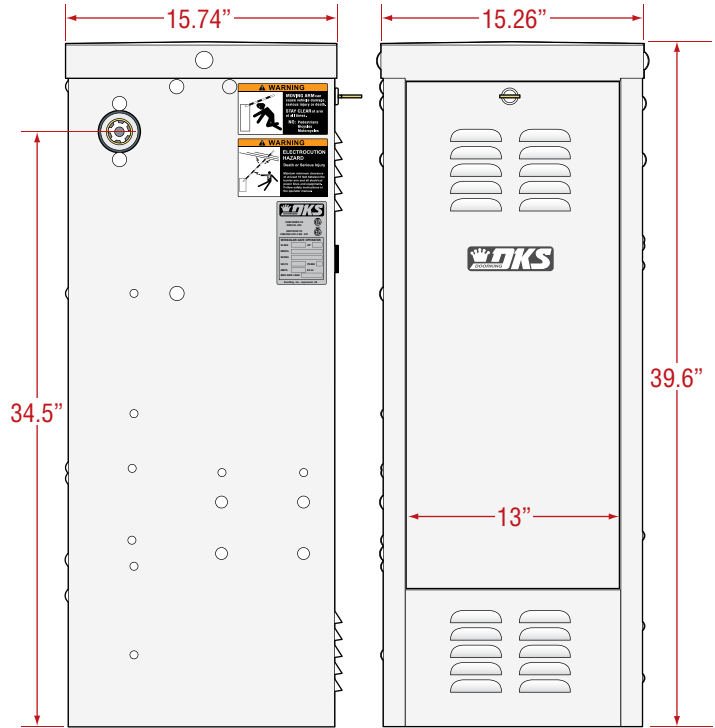

Model #	Convenience Open	Horsepower - Volts	Amp	Max Arm Length	Speed 90°
1602-090	No	1 HP - 115 VAC	9.7	28 Ft.	5.5 Sec
1602-091	Yes	1 HP - 115 VAC	9.7	28 Ft.	5.5 Sec

**Note:** 208/230/460/575 VAC input voltage can be connected to the operator by installing an "Optional" High Voltage Kit (P/N 2600-266).

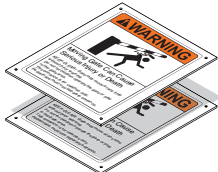

**2 Warning Signs (Included) MUST be mounted on EACH side of gated area and easily visible.**

Drawings not to scale

## 1602 Barrier Arm Kit Options

**Contact Sensor Note:** A reverse edge is **NOT** to be used as a replacement, or in lieu of, in-ground loops or non-contact sensor (photozell) that protect vehicles passing underneath the barrier arm. A **moving** vehicle coming in contact with a downward moving barrier arm **WILL** result in **damage to the vehicle** and the barrier arm/reversing edge if **NOT** using in-ground loops or non-contact sensor (Photozell).

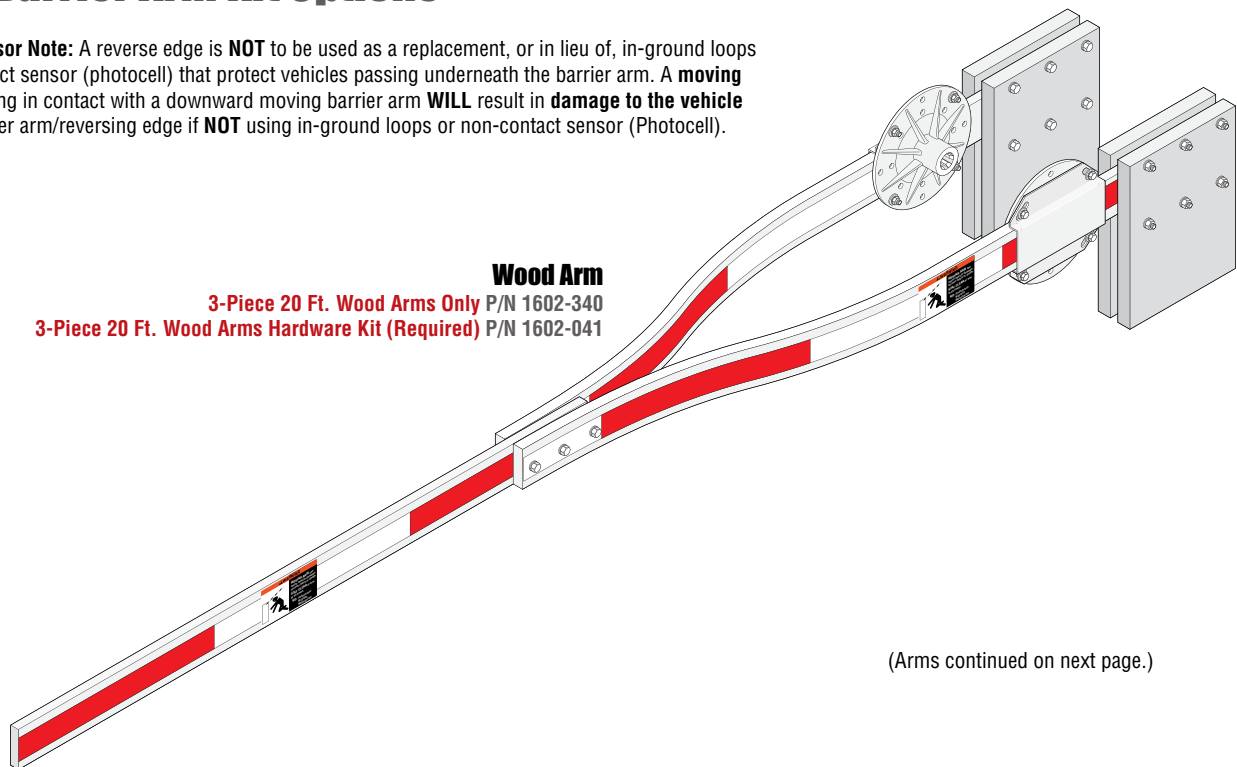

### Wood Arm

3-Piece 20 Ft. Wood Arms Only P/N 1602-340

3-Piece 20 Ft. Wood Arms Hardware Kit (Required) P/N 1602-041

(Arms continued on next page.)

# 1602 BARRIER ARM OPTIONS CONTINUED

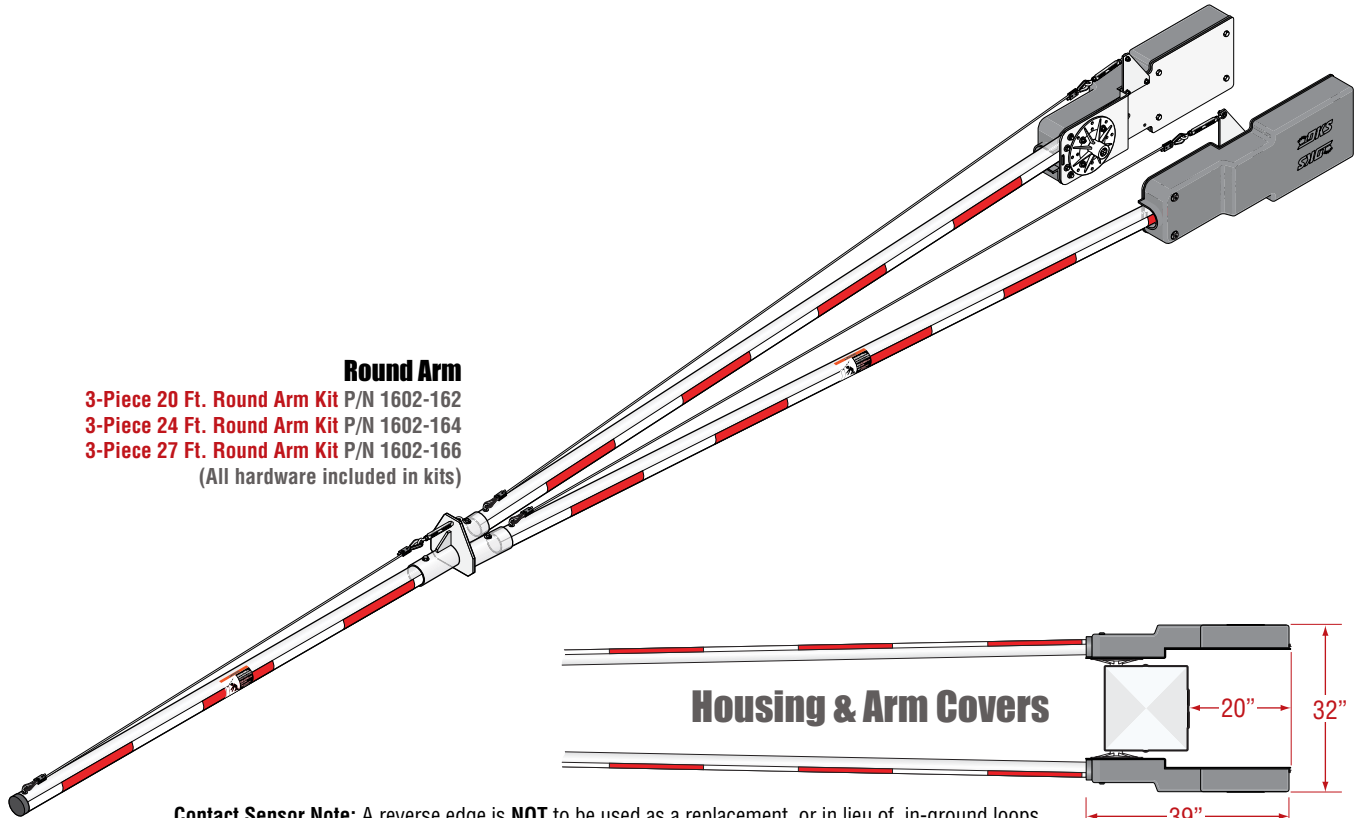

## Round Arm

- 3-Piece 20 Ft. Round Arm Kit P/N 1602-162
  - 3-Piece 24 Ft. Round Arm Kit P/N 1602-164
  - 3-Piece 27 Ft. Round Arm Kit P/N 1602-166
- (All hardware included in kits)

## Housing & Arm Covers

**Contact Sensor Note:** A reverse edge is **NOT** to be used as a replacement, or in lieu of, in-ground loops or non-contact sensor (photocell) that protect vehicles passing underneath the barrier arm. A **moving** vehicle coming in contact with a downward moving barrier arm **WILL** result in **damage to the vehicle** and the barrier arm/reversing edge if **NOT** using in-ground loops or non-contact sensor (Photocell).

## Octagon Arm

- 3-Piece 20 Ft. Octagon Arm Only P/N 1602-282
  - 3-Piece 24 Ft. Octagon Arm Only P/N 1602-284
  - 3-Piece 27 Ft. Octagon Arm Only P/N 1602-287
- (All hardware included with arms)

## Optional Octagon LED/Reverse Edge Kit

- 3-Piece 20 Ft. LED/Reverse Edge Kit P/N 1602-292  
(Fits on 1602-282 arm)
- 3-Piece 24 Ft. LED/Reverse Edge Kit P/N 1602-294  
(Fits on 1602-284 arm)
- 3-Piece 27 Ft. LED/Reverse Edge Kit P/N 1602-297  
(Fits on 1602-287 arm)

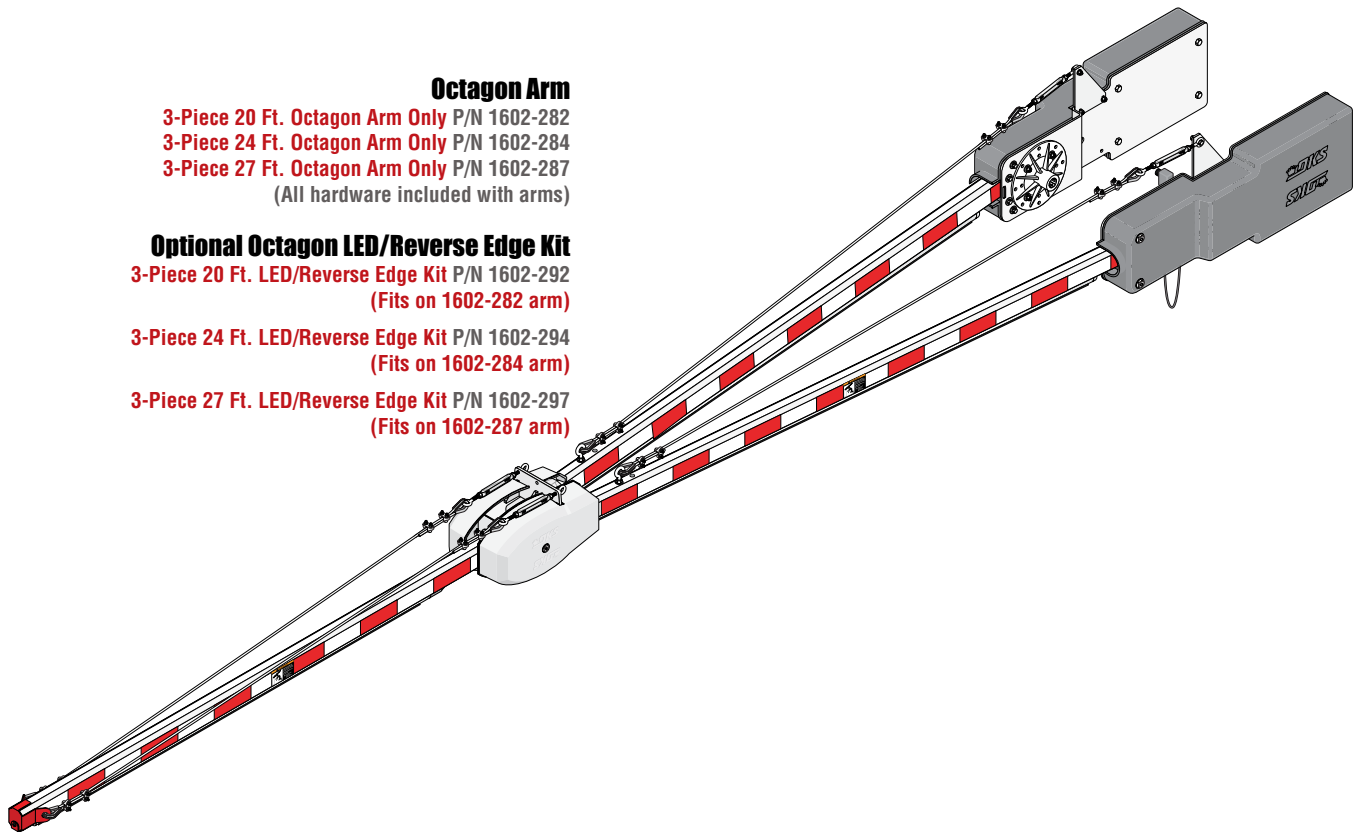

# SECTION 1 - INSTALLATION

Prior to beginning the installation of the barrier gate operator, we suggest that you become familiar with the instructions, illustrations, and wiring guide-lines in this manual. This will help insure that your installation is performed in an efficient and professional manner.

The proper installation of the vehicular barrier gate operator is an extremely important and integral part of the overall access control system. Check all local building ordinances and building codes prior to installing this operator. Be sure your installation is in compliance with local codes.

## 1.1 Safety and Underground Conduit Requirements

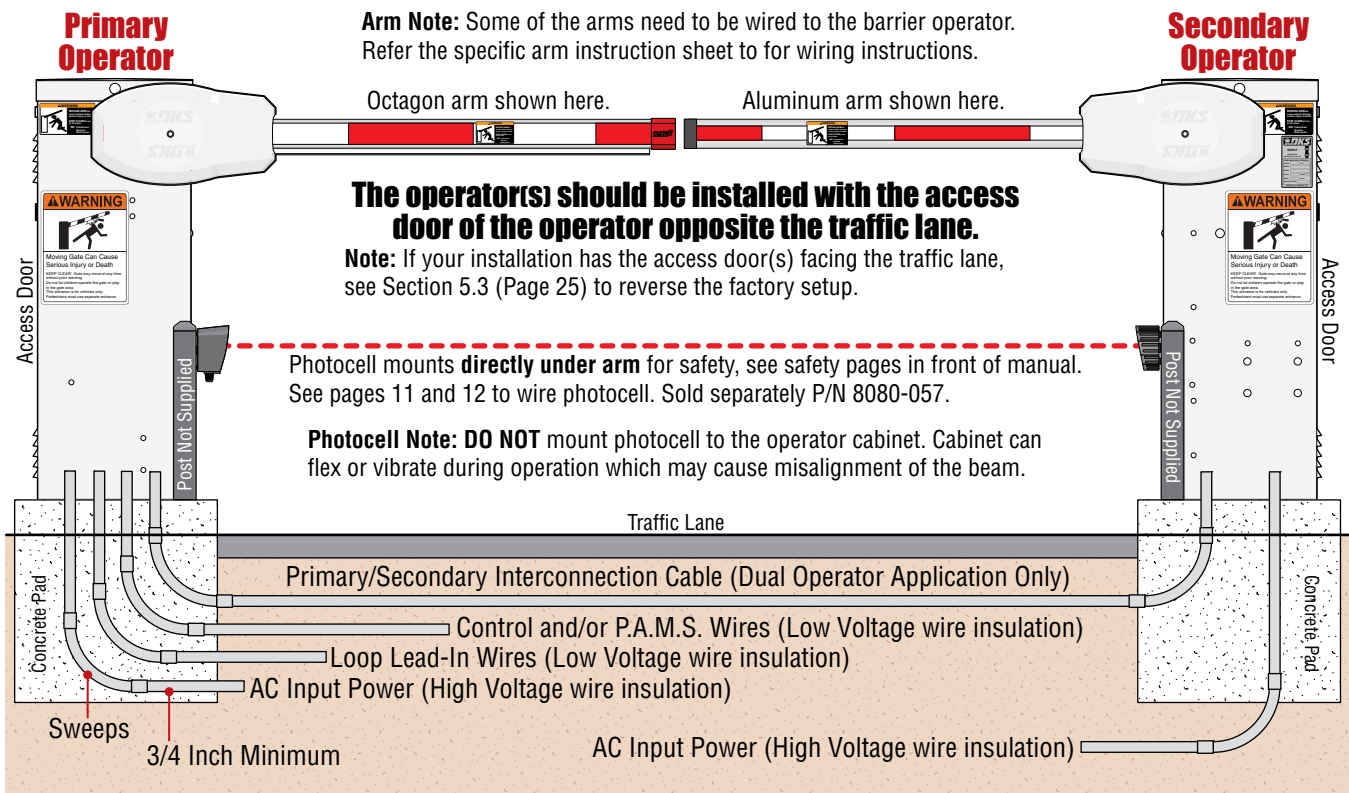

- The conduit requirements are for a typical slide gate operator installation (the secondary operator is shown for those applications where a secondary operator may be used). **The conduit requirements for your application may vary from this depending on your specific needs.**
  - Use only sweeps for conduit bends. Do not use 90° elbows as this will make wire pulls very difficult and can cause damage to wire insulation.
  - DoorKing recommends using 3/4-inch conduit.
- Sweep **YES**

Elbow **NO**
- Be sure that all conduits are installed in accordance with local codes.
  - **Never** run low voltage rated wire insulation in the same conduit as high voltage rated wire insulation.

# 1.2 New Concrete Pad

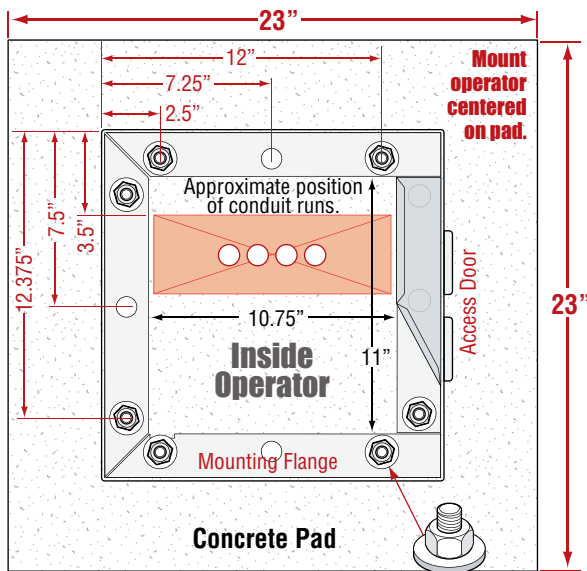

The operator(s) should be installed with the access door of the operator opposite the traffic lane.

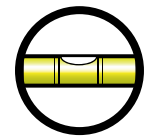

**Concrete pad MUST be level.**  
Note: Bevel the edges of concrete pad to eliminate water puddling under the operator.

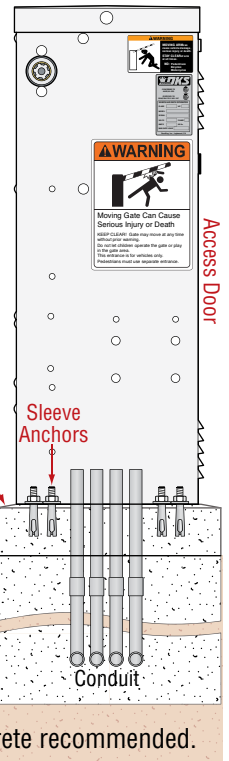

**IMPORTANT:** A barrier gate operator installed **WITHOUT** any external safety sensors **CANNOT** sense a person under the raised arm and can strike them while the arm is lowering. Install the photocell directly under the arm. See safety pages in front of this manual for more information.

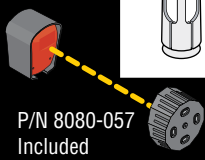

Secure the mounting flange to concrete with 3/4" x 3" sleeve anchors (not supplied).

# 1.3 Trenching Existing Concrete

Trench path(s) in the existing concrete wide enough for all the conduit runs. After the conduit has been run, fill the trench with soil to bottom of existing concrete and tamp down. Pour new concrete with a 4 inch pad height minimum (Reinforce concrete if possible). Secure the mounting flange to concrete with 3/4" x 3" sleeve anchors (not supplied). See illustration above for mounting operator.

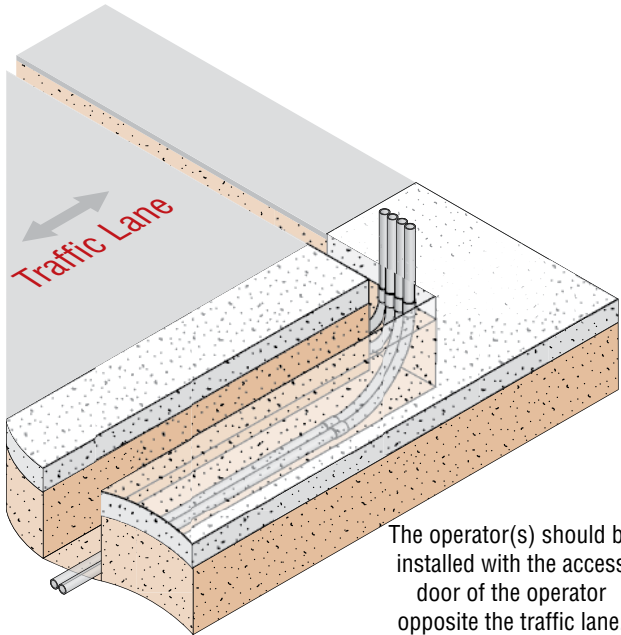

The operator(s) should be installed with the access door of the operator opposite the traffic lane.

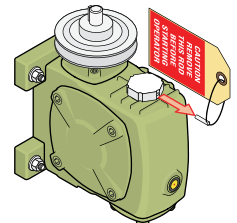

Remove breather pin from gear reducer **AFTER** the operator has been secured in place.

**IMPORTANT:** A barrier gate operator installed **WITHOUT** any external safety sensors **CANNOT** sense a person under the raised arm and can strike them while the arm is lowering. Install the photocell directly under the arm. See safety pages in front of this manual for more information.

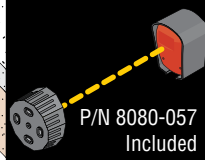

# SECTION 2 - WIRING

Before attempting to connect any wiring to the operator, be sure that the circuit breaker in the electrical panel is in the OFF position. Permanent wiring must be installed to the operator as required by local electrical codes. It is recommended that a licensed electrical contractor perform this work.

Since building codes vary from city to city, we highly recommend that you check with your local building department prior to installing any permanent wiring to be sure that all wiring to the operator (both high and low voltage) complies with local code requirements.

**THIS GATE OPERATOR MUST BE PROPERLY GROUNDED!!**

## 2.1 High Voltage Wire Runs

The distance shown in the chart is measured in “Feet” from the operator to the power source. If power wiring is greater than the maximum distance shown, it is recommended that a service feeder be installed. When large gauge wire is used, a separate junction box must be installed for the operator connection. The wire table is based on stranded copper wire. Wire run calculations are based on the NEC recommended maximum 3% voltage drop on the power line, plus an additional 10% reduction in distance to allow for other losses in the system.

**This table illustrates the high voltage AC power wire size and distance limitations.**

Model Type	Voltage Required	Amps Required	Wire Size / Max Distance in Feet			
			12 AWG	10 AWG	8 AWG	6 AWG
1601 - 1/2 HP	115	5.7	170	275	460	690
1602 - 1 HP	115	9.7	100	162	270	405

Never run low voltage rated wire insulation in the same conduit as high voltage rated wire insulation.

“Optional” Heater Installation Note: When installing a heater, refer to the “high voltage AC power wire size and distance limitations” table on the instruction sheet with the specific heater kits (115, 208/230, 460 VAC) for AC power wire run limitations.

“Optional” High Voltage Kit Installation Note: When installing the high voltage kit for 208/230/460/575 VAC input power, refer to the “high voltage AC power wire size and distance limitations” table on the instruction sheet with the high voltage kit (P/N 2600-266) for AC power wire run limitations.

## 2.2 High Voltage Terminal Connections

- Route incoming high voltage power in its **OWN** conduit.
- Be sure wiring is installed in accordance with local codes. Be sure to color code all wiring.
- It is recommended that a surge suppressor be installed on the high voltage power lines to help protect the operator and circuit board from surges and power fluctuations.
- Dual operators (Primary/Secondary) require AC power to each operator.

**⚠ Keep wire clear of all moving parts.**

**DO NOT** power up and cycle the operator until the “DIP-Switches” have been set for the 1601 OR 1602 model (See pages 22 thru 24). The operator will not function properly unless the switches have been correctly set.

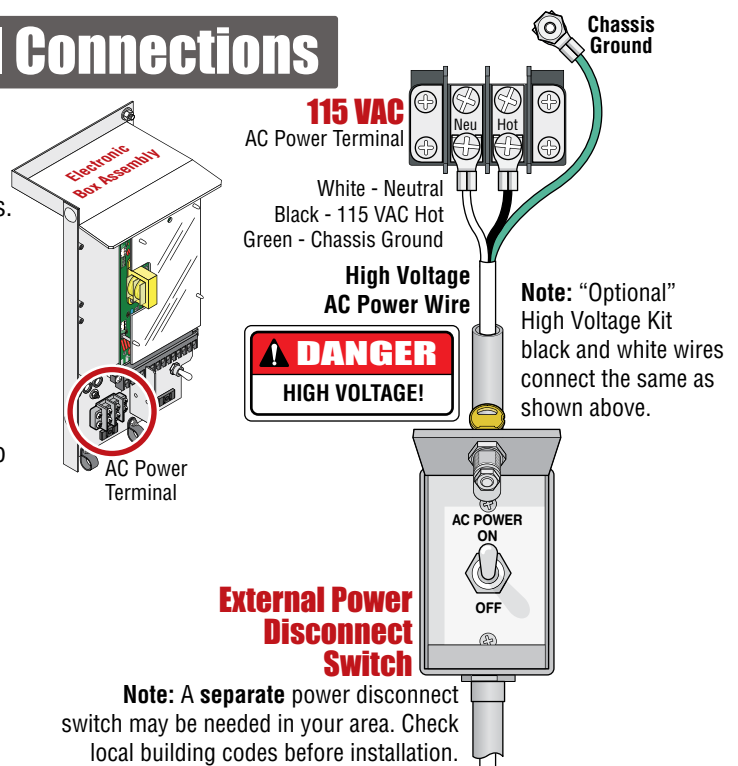

## 2.3 Dual Gate Operators (Primary/Secondary)

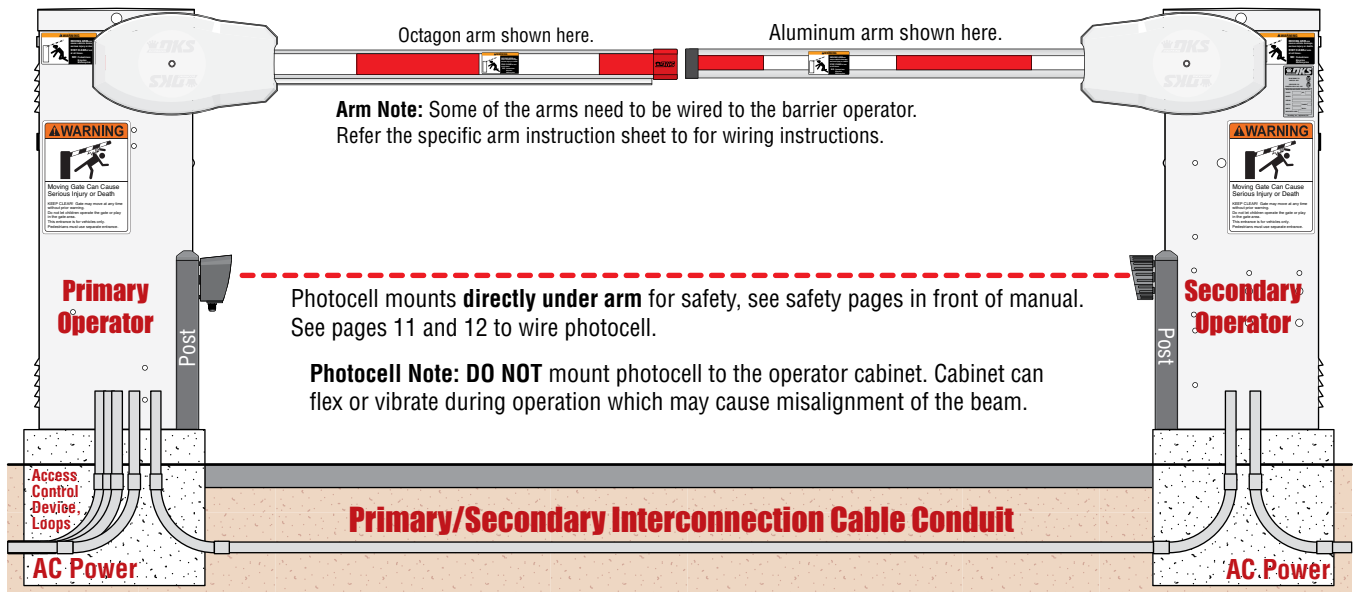

**Primary Circuit Board**

**Secondary Circuit Board**

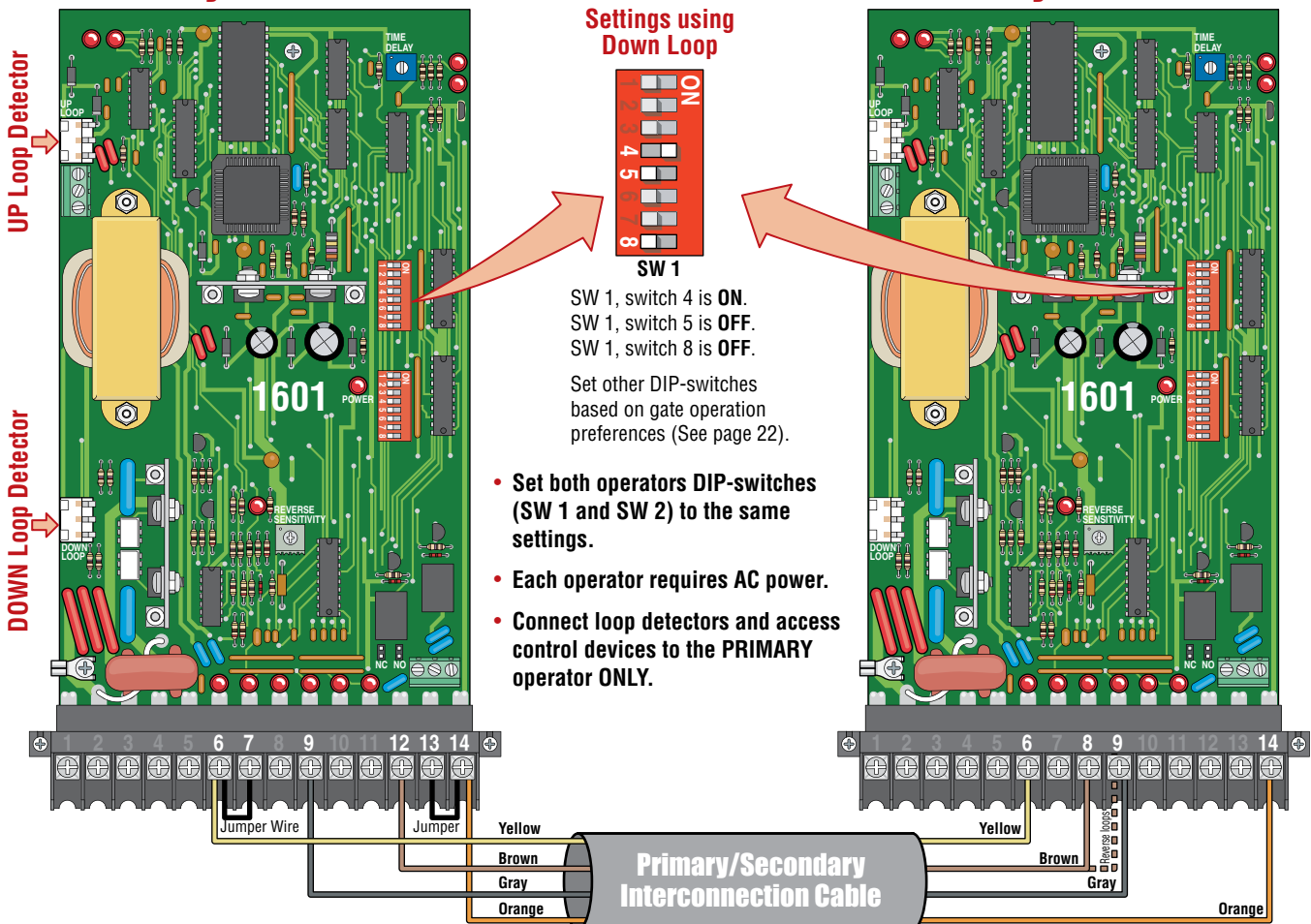

Sold separately from DoorKing.  
4 wires used (8 - 18 AWG wires total).

### When using Reverse Loops:

**DIP-Switch settings:** SW 1, switch 4 is **OFF**. SW 1, switch 5 is **OFF**. SW 1, switch 8 is **OFF**. Set other DIP-switches based on gate operation preferences.

**Interconnection cable:** The **BROWN** wire must be connected to **SECONDARY TERMINAL #9** along with the **GRAY** wire. All other terminal wire connections are the same as shown above.

# 2.4 Main Terminal Description

Relay Contacts

## Input LEDs:

The LED that is above the terminal wiring input will light when that terminal input gets activated.

**Terminal #5 Note:**  
Exceeding 250 mA of power from this terminal may cause the circuit board transformer to overheat, causing intermittent problems.

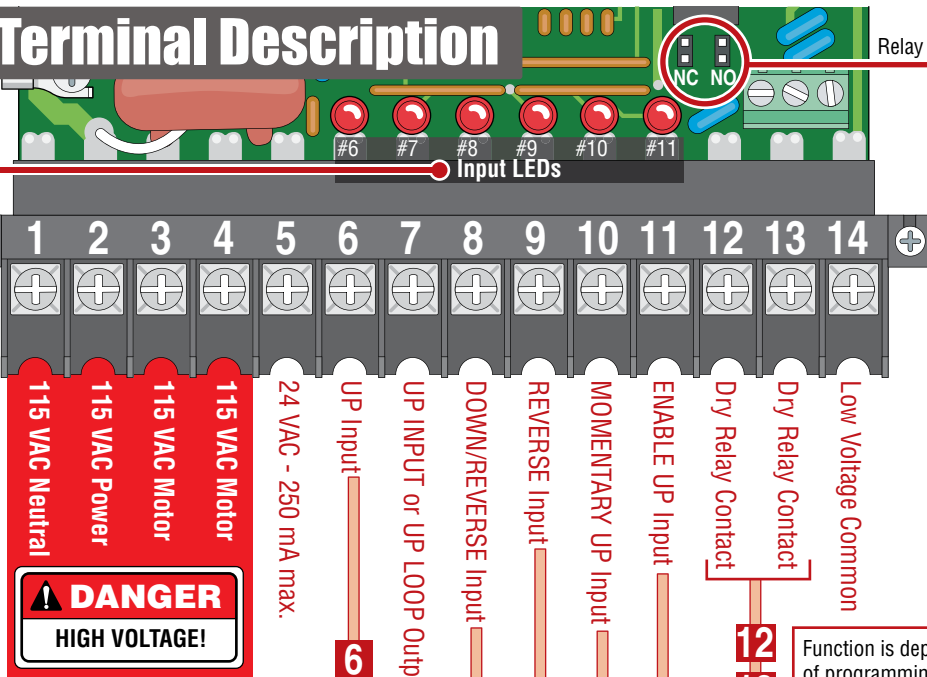

**DANGER**  
HIGH VOLTAGE!

Function is dependent on the setting of programming SW 1, switch 6. When switch 6 is **OFF**, this input will cause the operator to rotate the arm to the up position. If the arm is in the down cycle, this input will reverse the arm to the up position. If this terminal has a constant input, the arm will remain in the up position regardless of any down input or timer command to rotate down. When switch 6 is **ON**, this input will cause the operator to rotate the arm to the up position when it is down, and will cause the operator to rotate the arm to the down position when it is up. If the auto timer is turned ON (Not recommended if switch 6 is ON), this input will override the timer and rotate the arm to the down position. If the arm is in the down cycle, this input will reverse the arm to the up position.

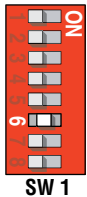

Function is dependent on the setting of programming SW 1, switch 5. When switch 5 is **OFF**, activation of the down loop will activate the relay. When switch 5 is **ON**, activation of the UP loop will activate the relay.



Relay contacts can be set for Normally Open (NO) or Normally Closed (NC) operation. Contact rating is 1 amp maximum at 24 Volts.

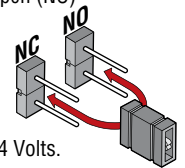

Function is dependent on the setting of programming SW 1, switch 8. When switch 8 is **ON**, the function of this input is identical to terminal 6. When switch 8 is **OFF**, this terminal becomes the logic output of the up loop detector.

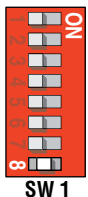

Function is dependent on the setting of programming SW 1, switches 1 and 4. With switch 1 **OFF** and switch 4 **ON**, activation and then deactivation of this input will rotate the arm to the down position, provided that the deactivation of the input happens while the arm is in the full up position. This input will override the auto timer if it is turned ON. If the arm is in the down position, traveling in the down cycle, or traveling in the up cycle, activation and deactivation of this input has no effect on the arm. With switches 1 and 4 are **ON**, activation and then deactivation of this input will rotate the arm to the down position after it reaches the full up position regardless of when the deactivation of the input occurred. When switch 4 is **OFF**, this input is identical to the reverse input, terminal 9.

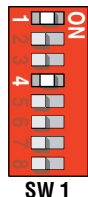

This input is used when sequencing the 1601 with a slide or swing gate operator in **PAMS** applications. This input is only active after a **MOMENTARY UP** input is received. Activation of this input will rotate the arm to the up position or reverse an arm in the down cycle to the up position.

This input is used when sequencing the 1601 with a slide or swing gate operator in **PAMS** applications. Activation of this input will rotate the arm to the up position one time, and activates the enable up input.

When the arm is in the down position, activation of this input has no effect. When the arm is in the up position, activation of this input will prevent the arm from rotating to the down position. If the arm is in the down cycle, activation of this input will reverse the arm to the up position. This input can be controlled to allow the arm to lower for tailgating vehicles but NOT get lowered when a pedestrian is underneath it. The 9411 plug-in loop detector must be installed for this function, see page 12 for more information about controlled non-contact sensors.



# 2.5 Control Wiring for Single/Primary Operator

DoorKing Access Control System (Model 1833, 1835, 1837 or 1838) tracker system can be connected. This system can keep track of gate operator cycle count, shorted inputs, loop detector problems, any forced entry attempts, if the gate has struck anything during the open or close cycle, power interruptions, etc. For more detailed information refer to the Tracker Installation and Wiring Manual, DoorKing P/N 2358-010.

Terminal 6 required only if the tracker board will activate the gate operator. Refer to the manual 2358-065 for detailed information.

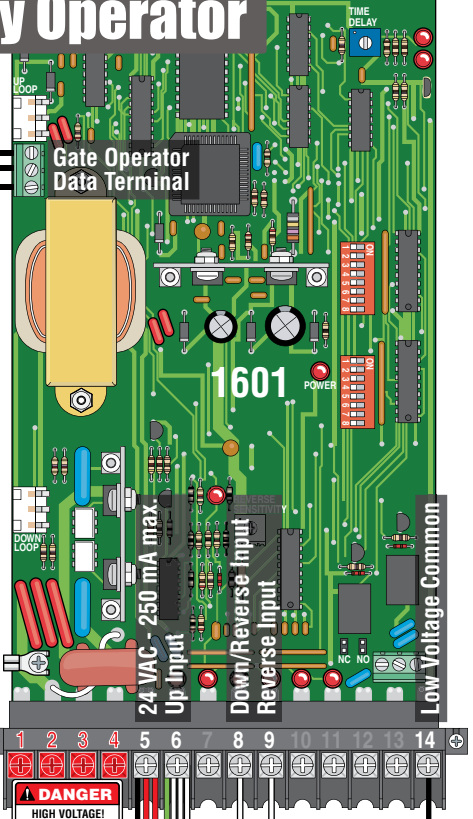
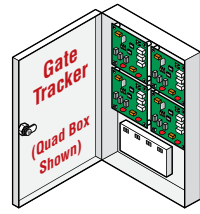

Type of wiring to be used on ALL external devices:  
**A) Type CL2, CL2P, CL2R, or CL2X.**  
**B) Other cable with equivalent or better electrical, mechanical, and flammability ratings.**

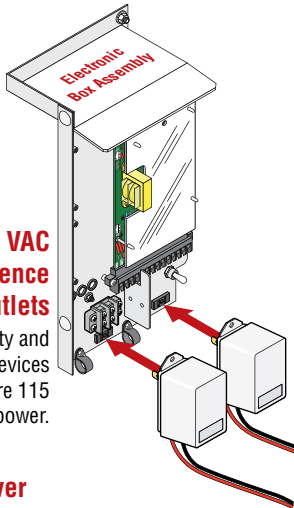

**115 VAC Convenience Outlets**  
 Power safety and opening devices that require 115 VAC power.

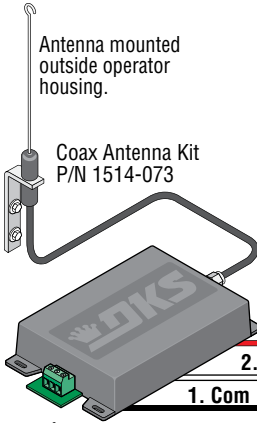

**3-Wire Radio Receiver**  
 3. 24 Volt  
 2. Relay  
 1. Com

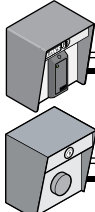

**Up-Inputs**  
**Down-Inputs**

**Terminal #5 Note:** Exceeding 250 mA of power from this terminal may cause the circuit board transformer to overheat, causing intermittent problems.



**Manual Gate Control Toggle**  
 P/N 1200-017

**WARNING**  
 User **MUST** make sure gate area **IS CLEAR** before manually operating gate arm.

**Up toggle position:** User toggles switch up to hold gate open.  
**Center toggle position:** Is neutral for normal operation.

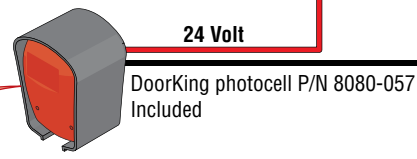

**Round Aluminum or Wood Arm Contact Sensor**  
 See page 30

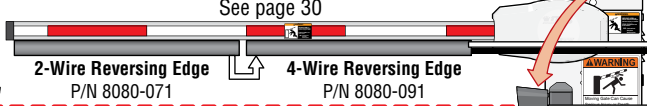

**Non-Contact Sensor (Always Reverses) (Photocell)**

Typical beam height 21" to 27.5"

**Contact Sensors Note:** Helps minimize the potential of the round aluminum or wood arm lowering on vehicular or other traffic that loops cannot sense.

**Non-Contact Sensor Connected to Reverse Input Note:** Helps minimize the arm lowering on anything that blocks beam. Lowering arm will **always reverse** when beam gets obstructed. **This setup does NOT distinguish between a vehicle and a pedestrian. It will reverse arm for either when beam gets obstructed.** See next page for pedestrian photocell wiring.

**Non-Contact Sensor Note:** **DO NOT** mount photocell to the operator cabinet. Cabinet can flex or vibrate during operation which may cause misalignment of the beam.

# 2.5 Continued

## Pedestrian Non-Contact Sensor

DoorKing offers a way to control vehicular traffic **AND** help protect pedestrians from a lowering arm. The arm will **NOT** allow a tailgating vehicle unauthorized entry, **BUT** protects pedestrians from a lowering arm when they are in the arm's swing path.

DoorKing's 9411 plug-in loop detector (sold separately) and a down loop **MUST** be installed directly under the arm for this detection system to function (see below).

See instruction sheet included with 9411 loop detector for more information about loop detector adjustments and wiring. Loop logic patent pending.

**Type of wiring to be used on ALL external devices:**  
**A) Type CL2, CL2P, CL2R, or CL2X.**  
**B) Other cable with equivalent or better electrical, mechanical, and flammability ratings.**

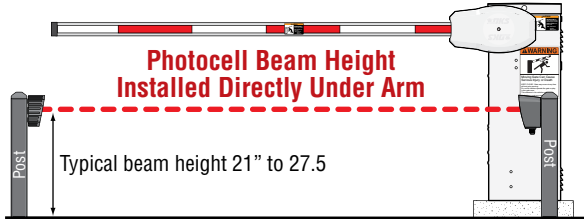
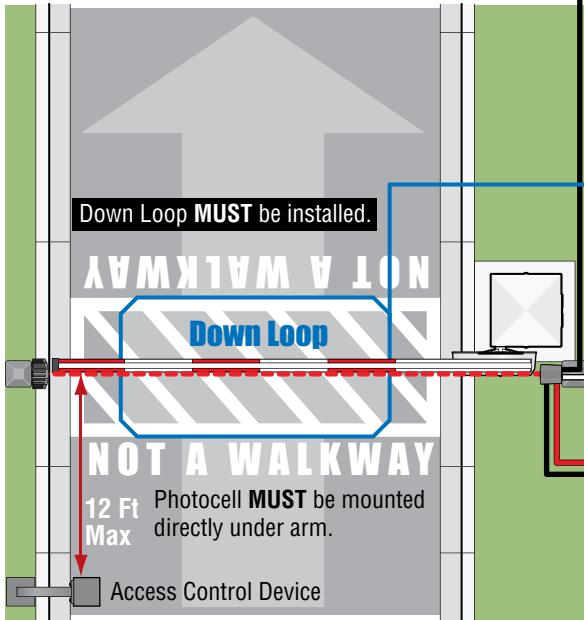

**Photocell Note: DO NOT** mount photocell to the operator cabinet. Cabinet can flex or vibrate during operation which may cause misalignment of the beam.

An obstructed photocell **WILL** reverse a lowering arm for a pedestrian but will **NOT** reverse a lowering arm for an unauthorized tailgating vehicle.

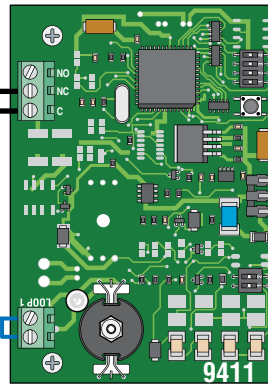
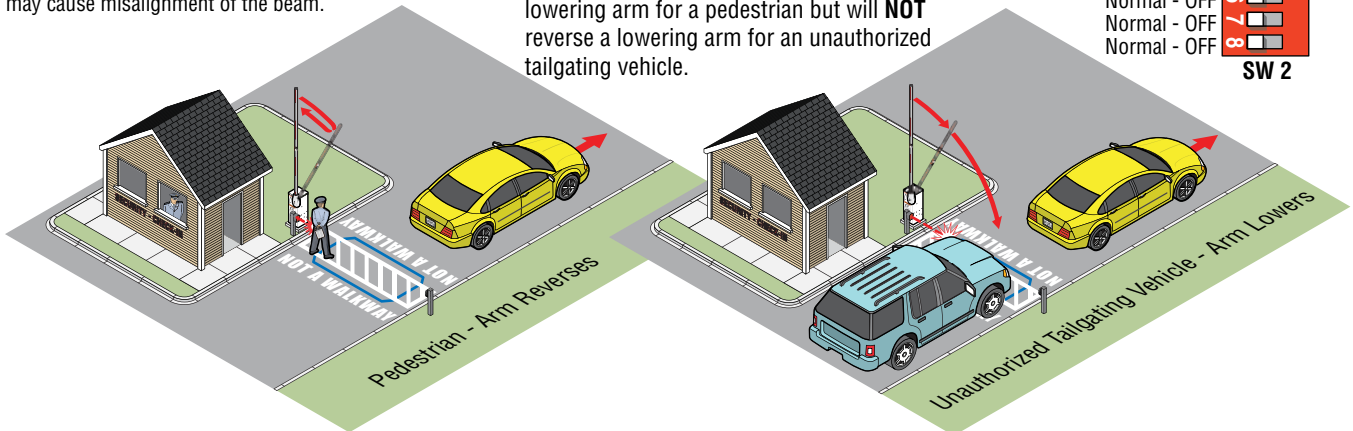

**DoorKing 9411 Plug-In Loop Detector Single Channel with Aux Relay**

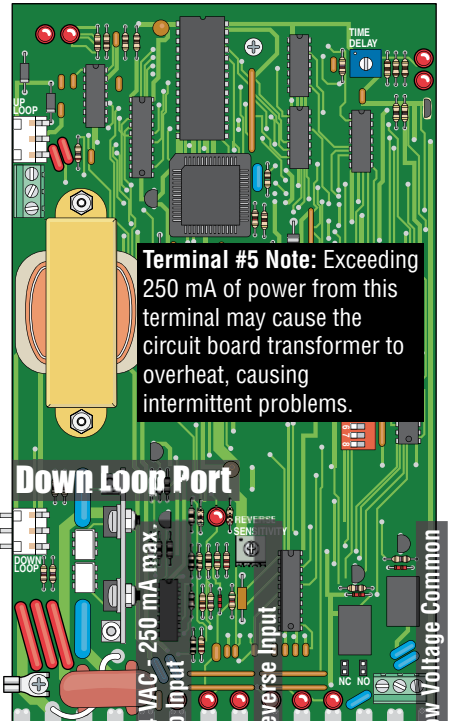

**Access Control Device**

Optional - Typical Card Reader, Keypad, etc.

**Up-Input**

**Typical DIP-Switch settings when using a 9411 Loop Detector with a Down Loop and a Access Control Device**

See page 22 for more information.

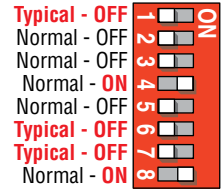

**SW 1**

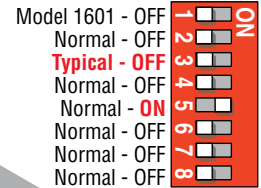

**SW 2**

## 2.6 P.A.M.S. Multiple Gate Operator Sequencing

Perimeter Access Management Solution (PAMS) application allows open and close cycle sequencing of a DoorKing barrier gate operator and a DoorKing slide or swing gate operator. For further information about this, go to DoorKing's web site at: [www.doorking.com](http://www.doorking.com)

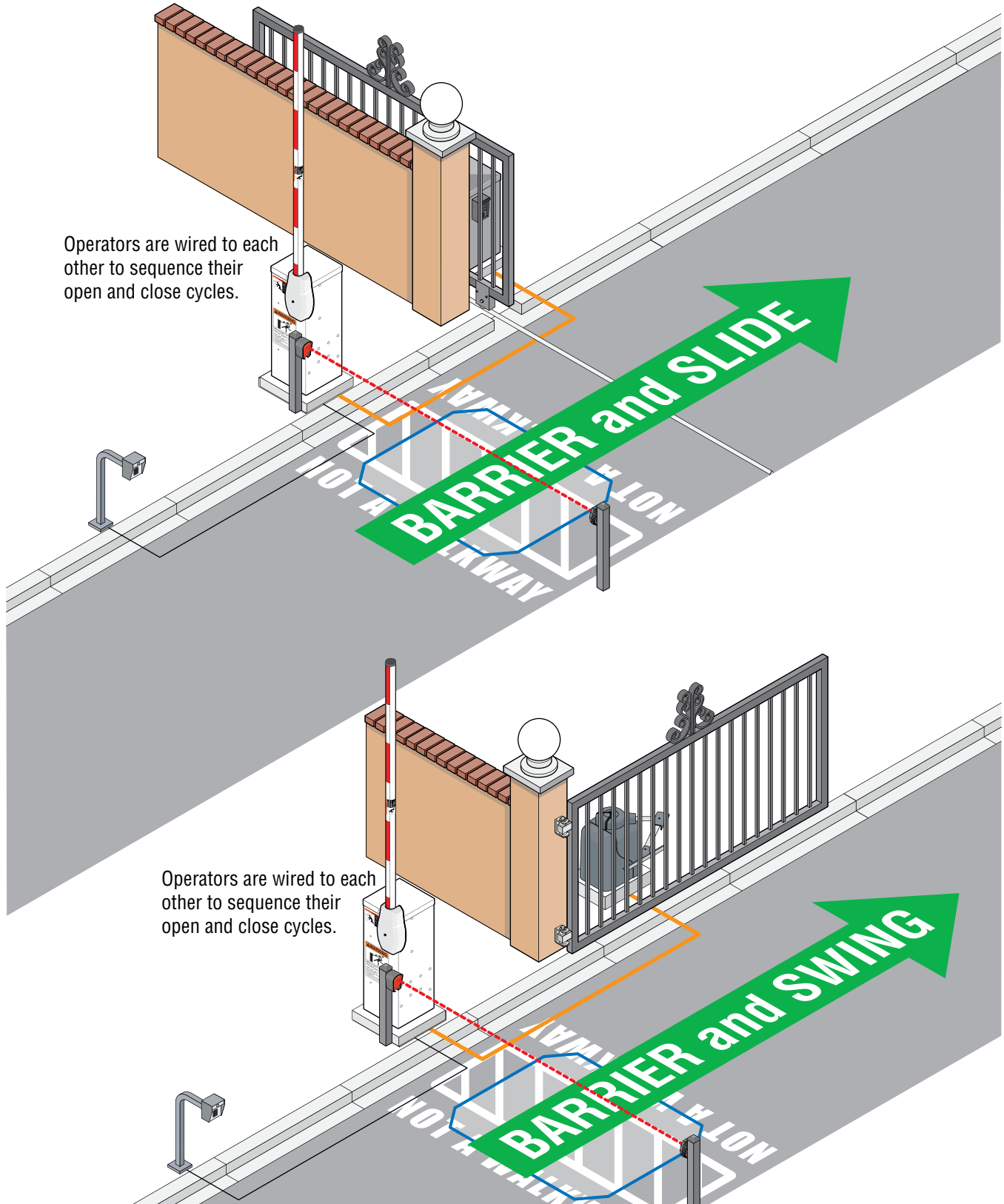

# SECTION 3 - LOOP DETECTOR LANE SETUPS

Before attempting to connect any wiring to the operator, be sure that the circuit breaker in the electrical panel is in the OFF position. Permanent wiring must be installed to the operator as required by local electrical codes. It is recommended that a licensed electrical contractor perform this work.

Loop detector wiring shown is for DoorKing model 9409 Dual Channel, 9410 Single Channel and 9411 Single Channel with Aux Relay plug-in loop detectors only.

If using other loop detectors refer to the separate Loop Information Manual for installation instructions, loops/preformed loops and wiring diagrams.

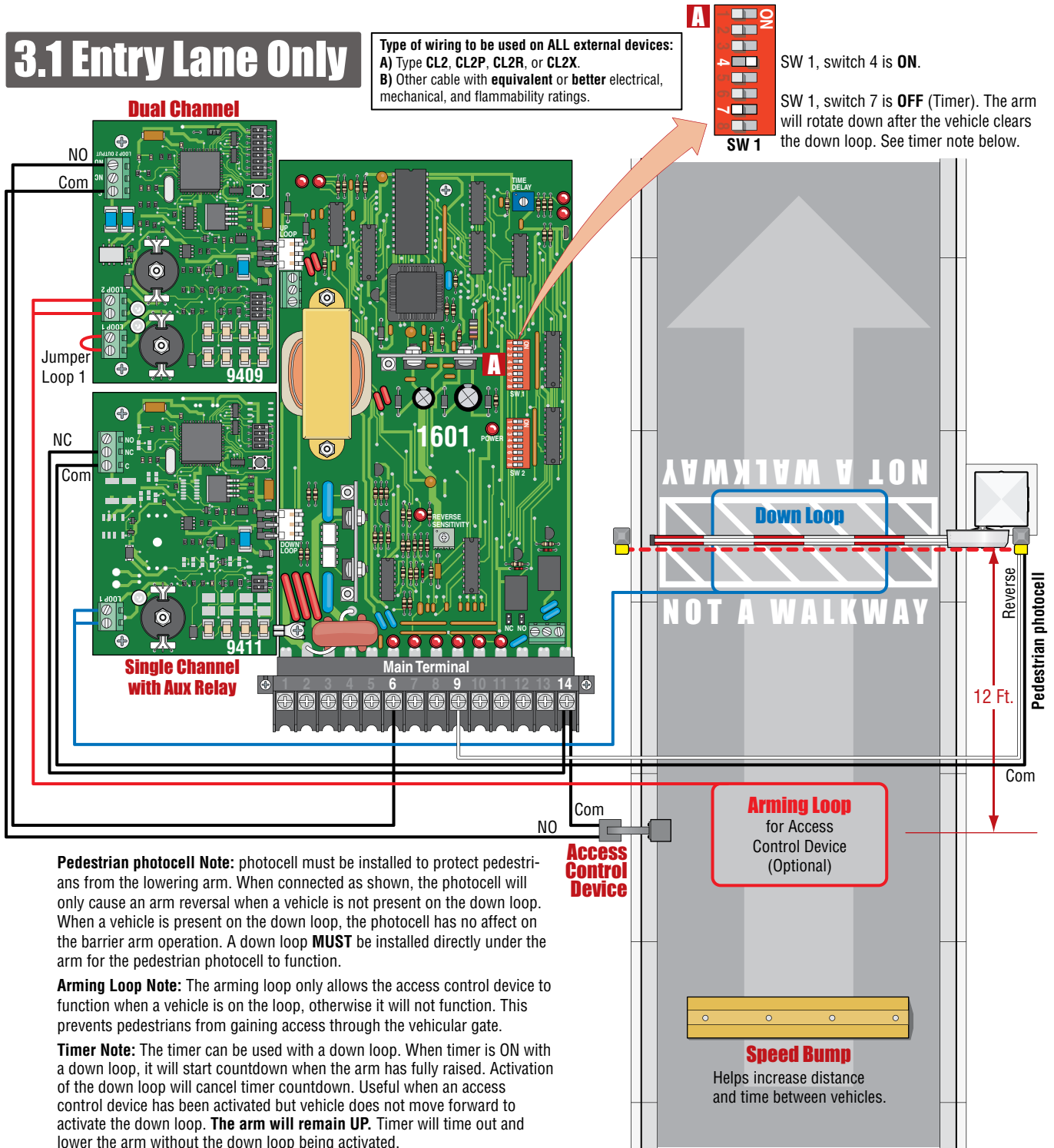

**Pedestrian photocell Note:** photocell must be installed to protect pedestrians from the lowering arm. When connected as shown, the photocell will only cause an arm reversal when a vehicle is not present on the down loop. When a vehicle is present on the down loop, the photocell has no effect on the barrier arm operation. A down loop **MUST** be installed directly under the arm for the pedestrian photocell to function.

**Arming Loop Note:** The arming loop only allows the access control device to function when a vehicle is on the loop, otherwise it will not function. This prevents pedestrians from gaining access through the vehicular gate.

**Timer Note:** The timer can be used with a down loop. When timer is ON with a down loop, it will start countdown when the arm has fully raised. Activation of the down loop will cancel timer countdown. Useful when an access control device has been activated but vehicle does not move forward to activate the down loop. **The arm will remain UP.** Timer will time out and lower the arm without the down loop being activated.

# 3.2 Exit Lane Only

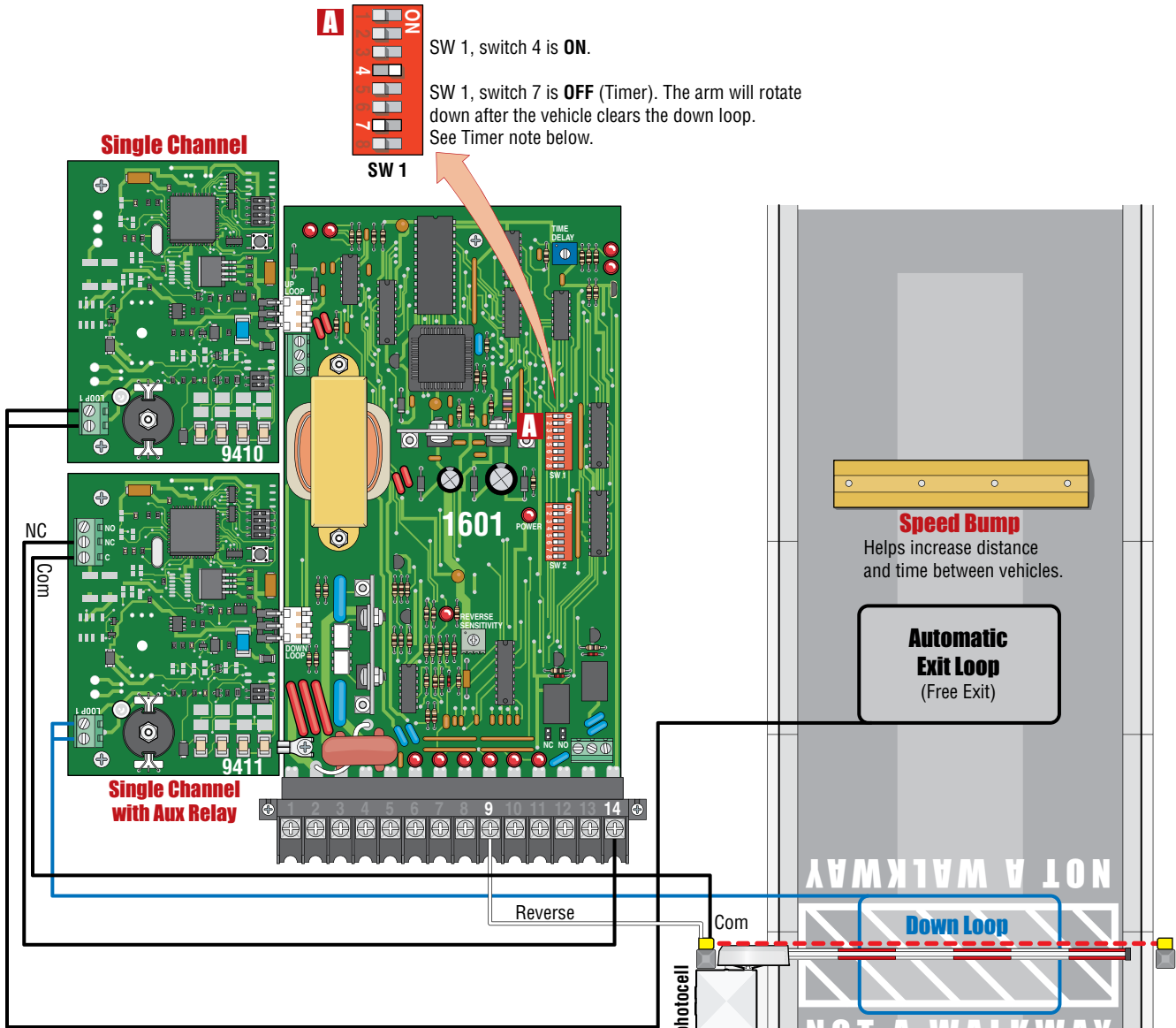

**Type of wiring to be used on ALL external devices:**  
**A)** Type CL2, CL2P, CL2R, or CL2X.  
**B)** Other cable with equivalent or better electrical, mechanical, and flammability ratings.

**Pedestrian photocell Note:** photocell must be installed to protect pedestrians from the lowering arm. When connected as shown, the photocell will only cause an arm reversal when a vehicle is not present on the down loop. When a vehicle is present on the down loop, the photocell has no effect on the barrier arm operation. A down loop **MUST** be installed directly under the arm for the pedestrian photocell to function.

**Timer Note:** The timer can be used with a down loop. When timer is ON with a down loop, it will start countdown when the arm has fully raised. Activation of the down loop will cancel timer countdown. Useful when the automatic exit loop has been activated but vehicle does not move forward to activate the down loop. **The arm will remain UP.** Timer will time out and lower the arm without the down loop being activated.

# 3.3 Two-Way Traffic Lane

**When a vehicle enters**, the down loop will be overridden by the automatic exit loop which will continue to hold the arm up. When the interior down loop has been cleared by the vehicle, the arm will lower.

**When a vehicle exits**, the automatic exit loop will raise arm and when the down loop is cleared, the arm will lower. The interior down loop is inoperative for exiting vehicles.

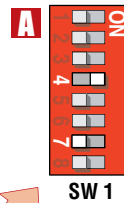

SW 1, switch 4 is **ON**.

SW 1, switch 7 is **OFF** (Timer). The arm will rotate down after the vehicle clears the down loops. See timer note below.

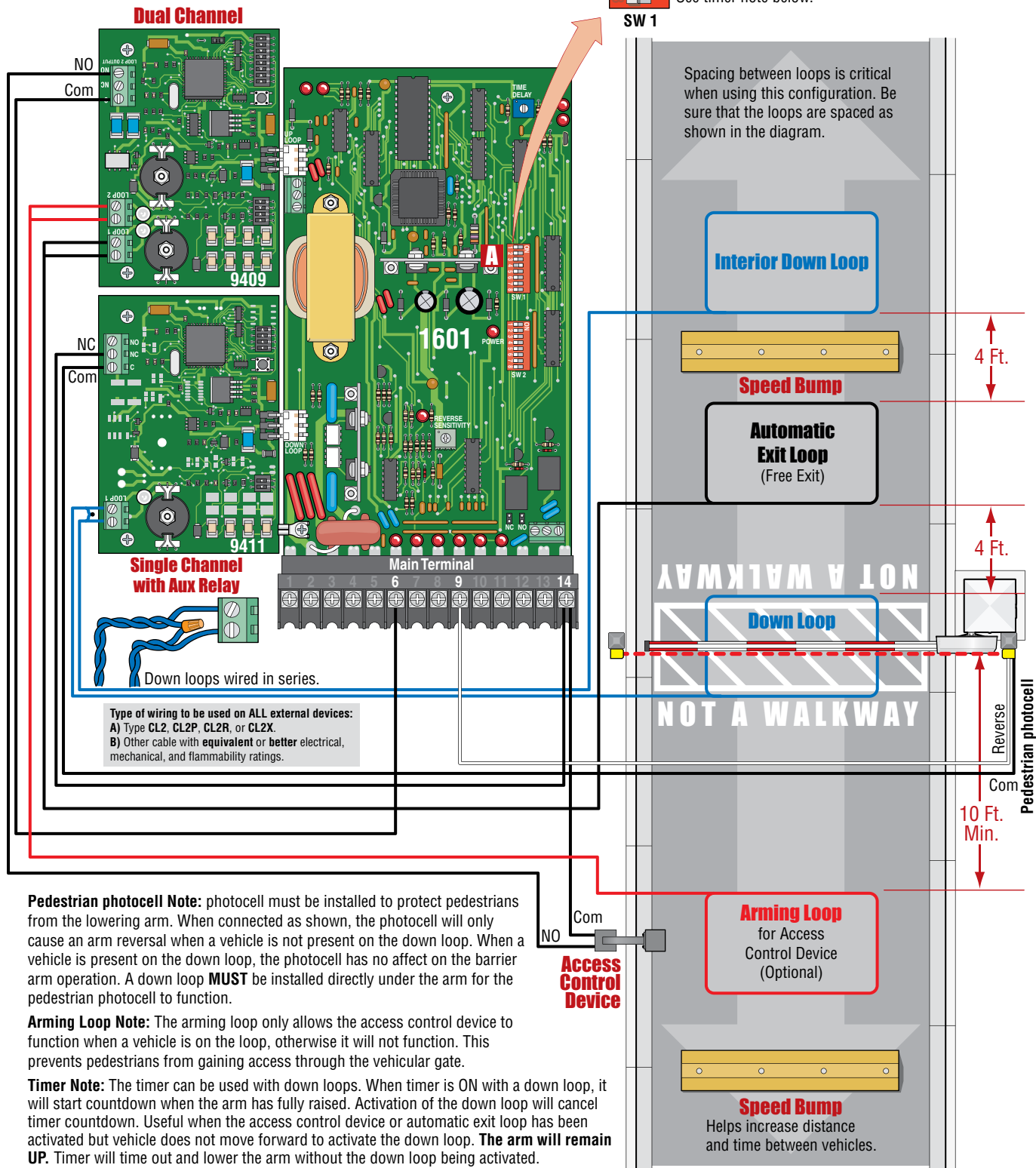

Spacing between loops is critical when using this configuration. Be sure that the loops are spaced as shown in the diagram.

Type of wiring to be used on ALL external devices:  
**A)** Type CL2, CL2P, CL2R, or CL2X.  
**B)** Other cable with equivalent or better electrical, mechanical, and flammability ratings.

**Pedestrian photocell Note:** photocell must be installed to protect pedestrians from the lowering arm. When connected as shown, the photocell will only cause an arm reversal when a vehicle is not present on the down loop. When a vehicle is present on the down loop, the photocell has no effect on the barrier arm operation. A down loop **MUST** be installed directly under the arm for the pedestrian photocell to function.

**Arming Loop Note:** The arming loop only allows the access control device to function when a vehicle is on the loop, otherwise it will not function. This prevents pedestrians from gaining access through the vehicular gate.

**Timer Note:** The timer can be used with down loops. When timer is ON with a down loop, it will start countdown when the arm has fully raised. Activation of the down loop will cancel timer countdown. Useful when the access control device or automatic exit loop has been activated but vehicle does not move forward to activate the down loop. **The arm will remain UP.** Timer will time out and lower the arm without the down loop being activated.

# 3.4 Ticket Spitter Entry Lane

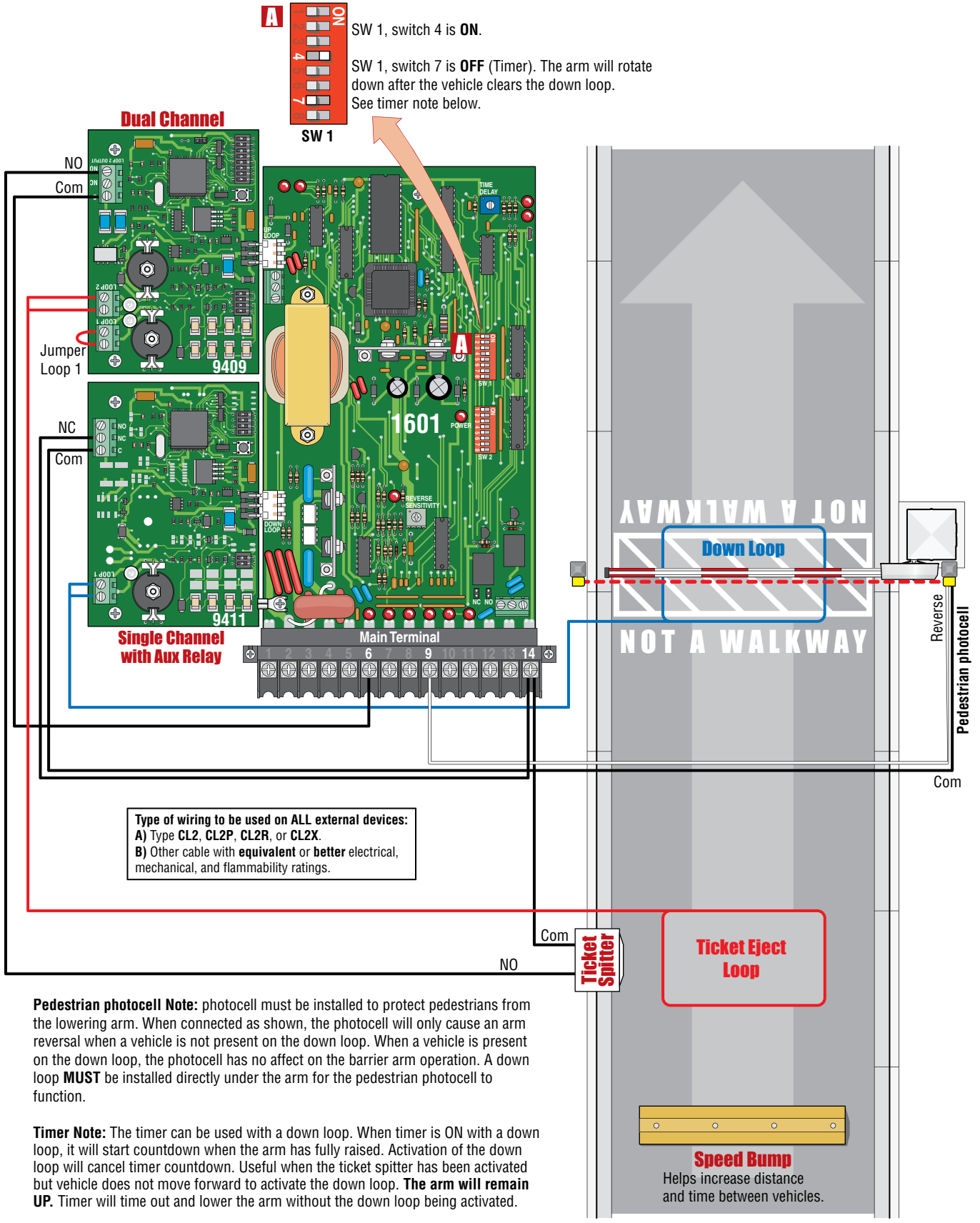

Type of wiring to be used on ALL external devices:  
**A)** Type CL2, CL2P, CL2R, or CL2X.  
**B)** Other cable with equivalent or better electrical, mechanical, and flammability ratings.

**Pedestrian photocell Note:** photocell must be installed to protect pedestrians from the lowering arm. When connected as shown, the photocell will only cause an arm reversal when a vehicle is not present on the down loop. When a vehicle is present on the down loop, the photocell has no effect on the barrier arm operation. A down loop **MUST** be installed directly under the arm for the pedestrian photocell to function.

**Timer Note:** The timer can be used with a down loop. When timer is ON with a down loop, it will start countdown when the arm has fully raised. Activation of the down loop will cancel timer countdown. Useful when the ticket spitter has been activated but vehicle does not move forward to activate the down loop. **The arm will remain UP.** Timer will time out and lower the arm without the down loop being activated.

# 3.5 Operator Timer ON Entry Lane (No Down Loop)

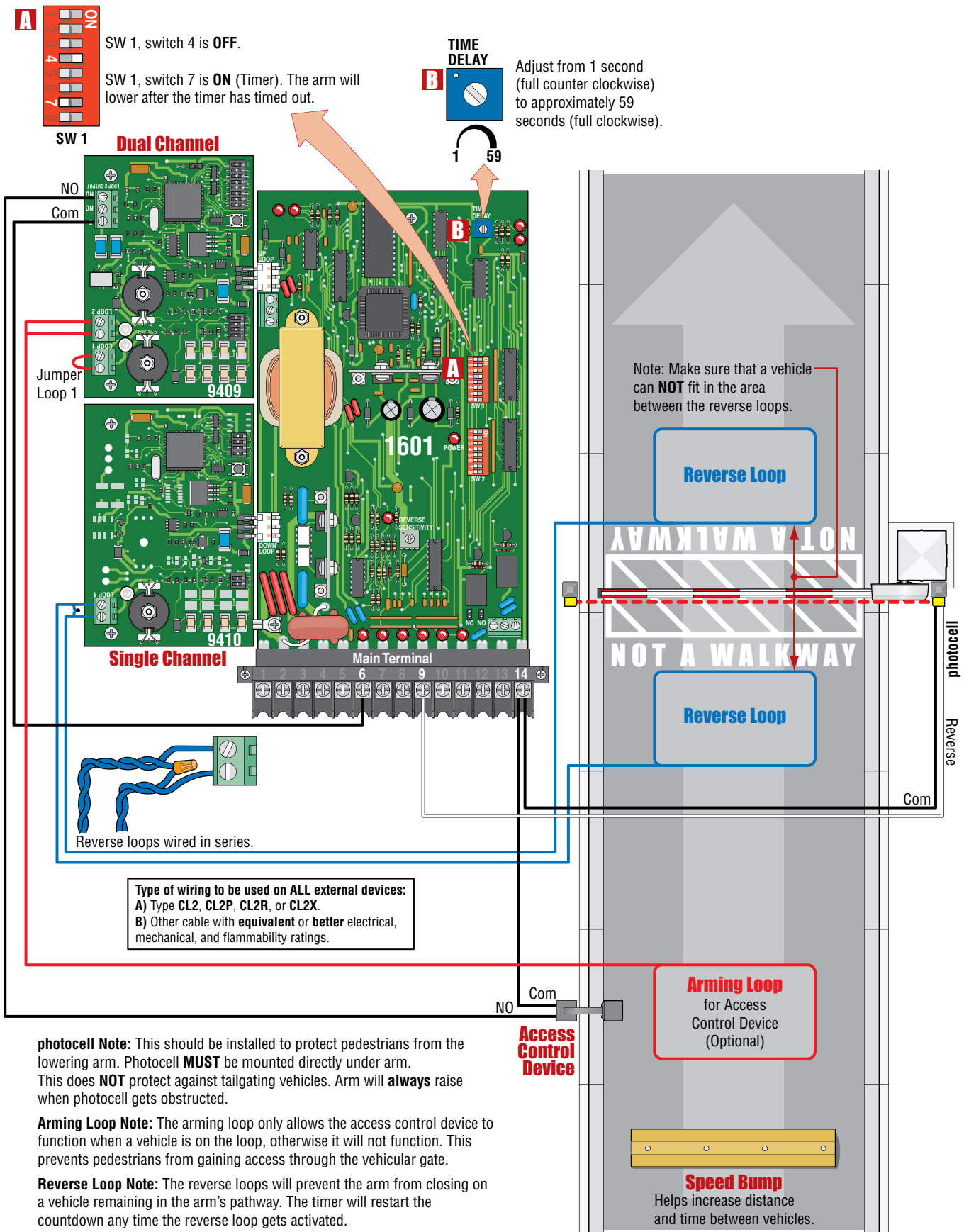

**photocell Note:** This should be installed to protect pedestrians from the lowering arm. Photocell **MUST** be mounted directly under arm. This does **NOT** protect against tailgating vehicles. Arm will **always** raise when photocell gets obstructed.

**Arming Loop Note:** The arming loop only allows the access control device to function when a vehicle is on the loop, otherwise it will not function. This prevents pedestrians from gaining access through the vehicular gate.

**Reverse Loop Note:** The reverse loops will prevent the arm from closing on a vehicle remaining in the arm's pathway. The timer will restart the countdown any time the reverse loop gets activated.



# SECTION 4 - ARM INSTALLATION

Arm installation varies depending on the operator model and individual installation requirements. All operators are equipped with 2 hub connections on opposite sides of the operator. Refer to instruction sheet that comes with **YOUR CHOSEN ARM** to install arm. Arm options are on pages 2-5.

The 1601 operates with a single 14 ft arm (either straight or folding arm).

The 1601 **CAN NOT** operate with the 20 ft, 24 ft and 27 ft 3-piece arm assemblies.

The 1602 operator is designed for the 3-piece 20 ft, 24 ft and 27 ft arms only.

## 4.1 Mounting Hub(s)

Mount hub(s) as shown with operator in the **DOWN** position. A single hub should be mounted on the **SAME** side as oncoming traffic.

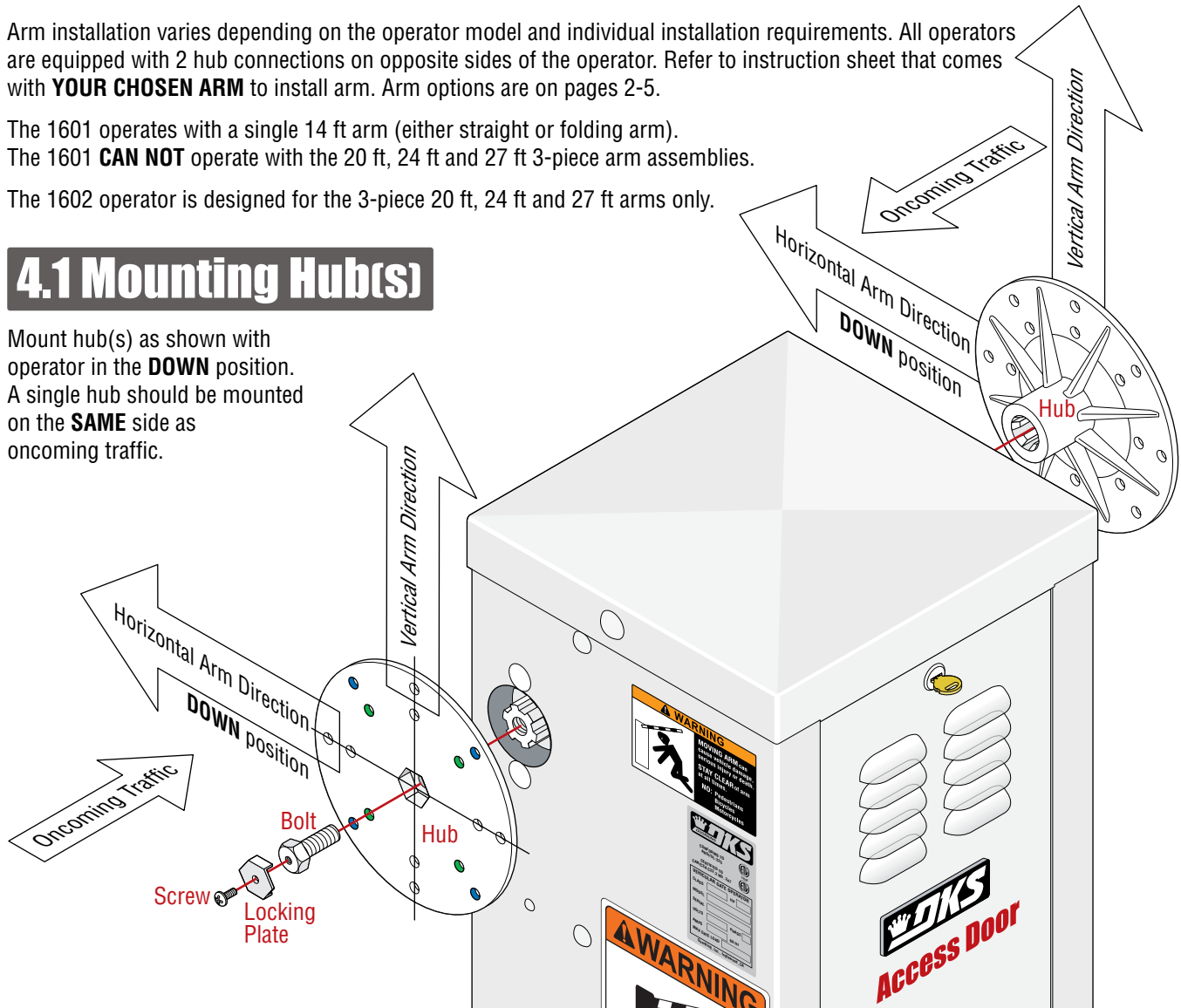

## Arm Direction and Bracket Hole Positions

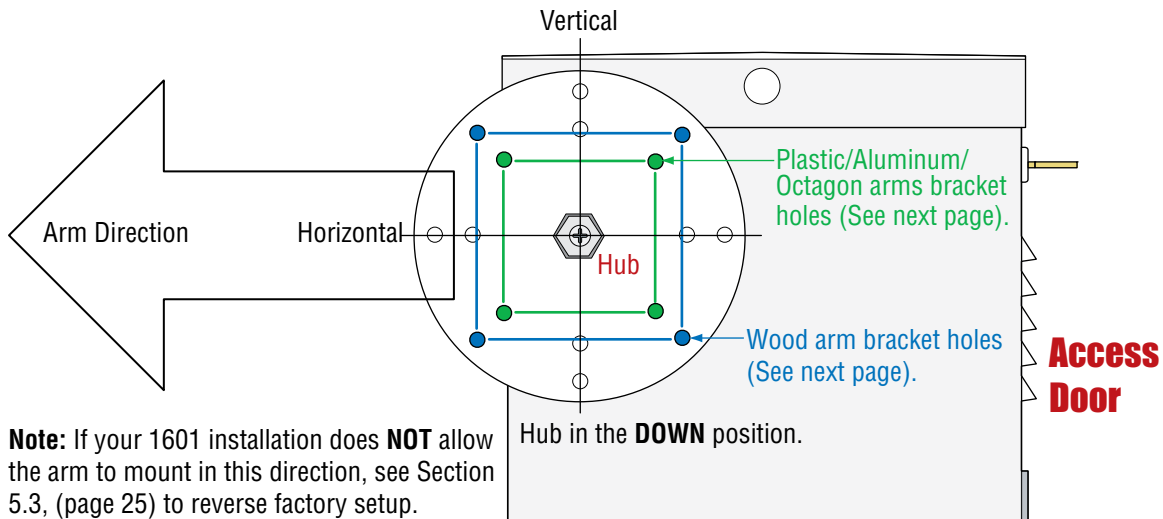

## 4.2 1601 Mounting Arm

Refer to instruction sheet that comes with **YOUR CHOSEN ARM** to install arm. Arm options are on pages 2 and 3.

### Wood Arm Installation

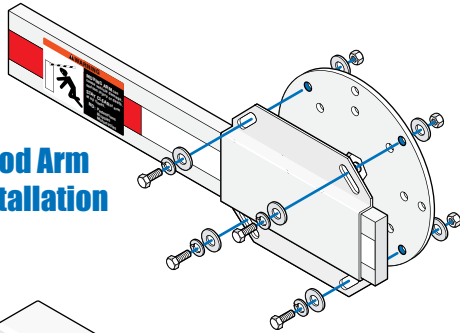

### Plastic Arm Installation

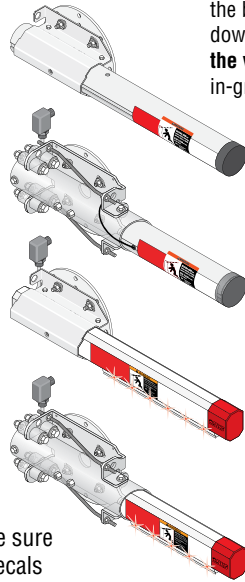
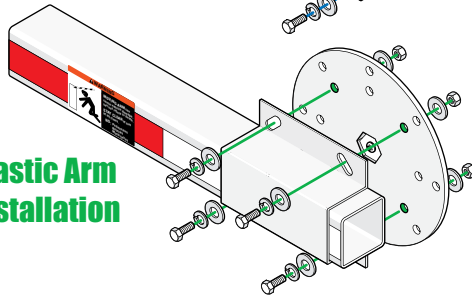

### Round Aluminum Arms

### Round Aluminum Break-Away Arms

### Octagon Arms

### Octagon Break-Away Arms

**Note:** Make sure Warning decals are on **BOTH** sides of arm.

**Contact Sensor Note:** A reverse edge is **NOT** to be used as a replacement, or in lieu of, in-ground loops or non-contact sensor (photocell) that protect vehicles passing underneath the barrier arm. A **moving** vehicle coming in contact with a downward moving barrier arm **WILL** result in **damage to the vehicle** and the barrier arm/reversing edge if **NOT** using in-ground loops or non-contact sensor (Photocell).

See specific instruction sheet that comes with your chosen arm kit for assembly.

## 4.3 1602 3-Piece Arm Assemblies

Arm options are on pages 4-5. Counter-balance weights are mandatory and **MUST** be installed on any style arm.

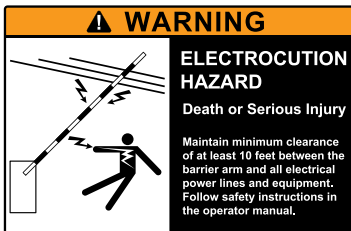

**2 Warning Signs (Included) MUST** be mounted on **EACH** side of gated area and easily visible.

Make sure **NO** overhead high voltage power wires are within 10 ft of the aluminum arm in the raised position.

### 20, 24 and 27 Ft. Octagon Arm

Keep all debris (Snow and Ice) off of arms during operation. Damage could occur to operator.

### 20, 24 and 27 Ft. Round Arm

See specific instruction sheet that comes with your chosen arm kit for assembly.

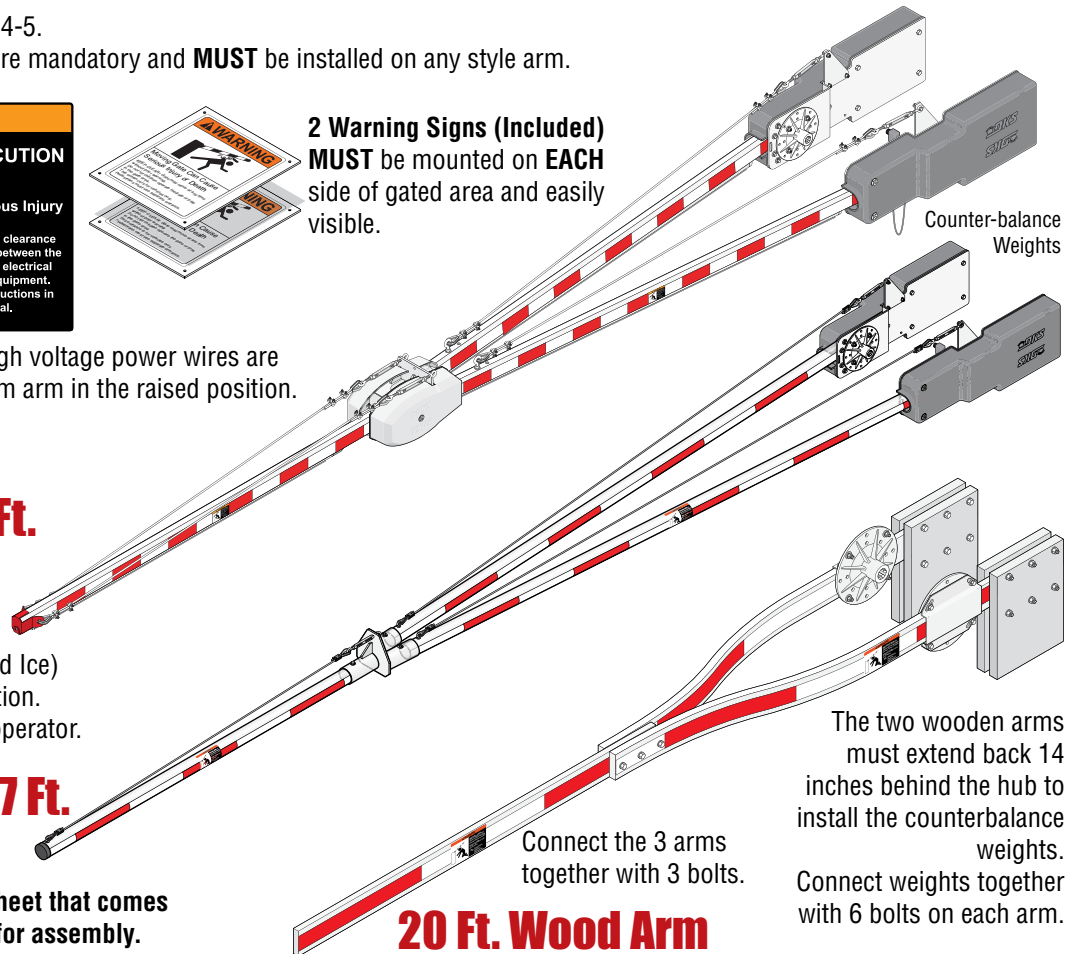

Counter-balance Weights

Connect the 3 arms together with 3 bolts.

The two wooden arms must extend back 14 inches behind the hub to install the counterbalance weights. Connect weights together with 6 bolts on each arm.

### 20 Ft. Wood Arm

Test hub **UP** and **DOWN** position before installing arm(s).

# SECTION 5 - ADJUSTMENTS

The switch settings and adjustments in this chapter should be made after your installation and wiring to the operator is complete. **Whenever any of the programming switches on the circuit board are changed, power must be shut-off, and then turned back on for the new setting to take effect.**

## 5.1 1601 Circuit Board Description and Adjustments

### Gate Tracker Activity LED

An automatic sensor system that senses entrapment of a solid object and is incorporated as a permanent and integral part of the operator.

### Gate Operator Data Terminal

Operator status reporting; cycle count, shorted inputs, loop detector problems, power interruptions, etc. See page 11.

### Auto Close Timer

Auto close timer (when turned on) SW 1, switch 7.

Adjust from 1 second (full counter clockwise) to approximately 59 seconds (full clockwise).



SW 1



### How LEDs Function



Illuminated LEDs Indicates that low voltage power is being applied to the circuit board.

**Input LEDs** should be OFF and will only illuminate when the input is activated.

**Limit LEDs** will only illuminate when the respective limit sensor has been activated.

### Self Test

Self test (when turned on) SW 1, switch 2.

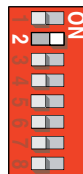

SW 1

### DIP-Switches

Set the DIP-switches on the circuit board to the desired setting. See switch settings information on the next 3 pages.

Note: SW 2, switch 1 **MUST** be set for the correct model operator that has been installed.

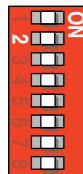

SW 1

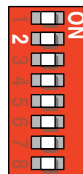

SW 2

### Arm Relay Contacts

(C – NC – NO) This relay can be used for a variety of purposes and is typically used to signal when the arm is up or down.

### Dry Relay Contact

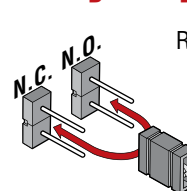

Relay activation is dependant on setting of SW 1, switch 5.



SW 1

Dry relay contacts (terminals 12-13) can be set for Normally Open (NO) or Normally Closed (NC) operation by placing the relay shorting bar on the N.O. or N.C. pins respectively. See page 10 and next page.

### Single Channel Loop Detector

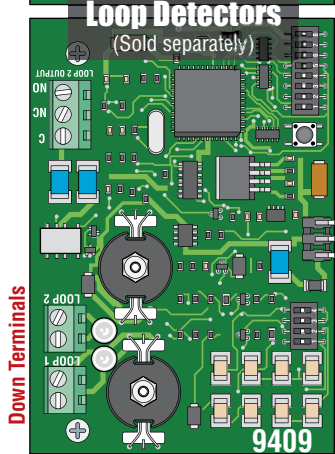
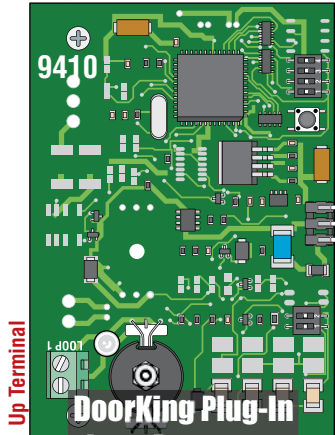

### Dual Channel Loop Detector

### Reverse Sensor

Adjust reversing sensitivity for the DOWN direction of arm. See page 26.

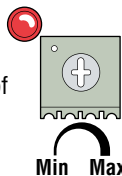

**Input LEDs Note:** The LED that is above the terminal wiring input will light when that terminal input gets activated.

## 5.2 DIP-Switch SW 1 and SW 2 Settings

The two DIP-switches located on the circuit board are used to program the operator to operate in various modes and to turn on or off various operating features. Whenever a switch setting is changed, power to the operator must be turned OFF and then turned back on for the new setting to take affect. Check and review ALL switch settings prior to applying power to the operator.

SW 1 (Top 8 Switches)			
Switch	Function	Setting	Description
1	Down Active when arm is full up.	OFF	Activation and then deactivation of the down loop or down / reverse input will cause the arm to rotate down ONLY if the deactivation occurred after the arm reached the FULL UP position.
	Down Active when arm is moving up or is up.	ON	Activation and then deactivation of the down loop or down / reverse input will cause the arm to rotate down AFTER reaching the FULL UP position regardless of when the deactivation occurred.
2	Self-Test	OFF	<b>Normal setting.</b> Self-test is turned off.
		ON	Run self-test.
3	Gear Box Travel	OFF	<b>Normal setting.</b> Operator uses 360° of gearbox. Extends wear life of gearbox.
		ON	Operator uses 180° of gearbox. See page 26.
4	Down / Reverse Loop and Input	OFF	Down / Reverse loop and input will function as a REVERSE loop and REVERSE input.
		ON	<b>Normal setting.</b> Down / Reverse loop and input will function as a down input and cause the arm to rotate down upon deactivation of the input. See SW 1, switch 1 for additional information.
5	Relay 1 Activation	OFF	<b>Normal setting.</b> Relay activates when the DOWN loop detector (DoorKing plug-in detector only) senses a vehicle presence.
		ON	Relay activates when the UP loop detector (DoorKing plug-in detector only) senses a vehicle presence.
6	Up Input Function	OFF	Up Input will raise arm and/or reset the down timer. Input will not lower the arm.
		ON	Up Input will raise arm if it is down, or will lower arm if it is up.
7	Timer	OFF	Timer to lower arm is OFF.
		ON	Timer to lower arm is ON. Set from 1 to 59 seconds for close time delay. Timer can be used as a <b>secondary</b> closing command for a down loop. Timer countdown starts when arm has fully raised. Down loop activation will cancel timer and lower arm <b>OR</b> arm will lower when timer has timed out.
8	Up Loop Port Input	OFF	Output of the loop detector plugged into the UP loop port is switched to terminal 7 for connection to other input terminals.
		ON	<b>Normal setting.</b> Output of the loop detector plugged into the UP loop port will raise arm when activated.

SW 2 (Bottom 8 Switches)			
Switch	Function	Setting	Description
1	Model 1601	OFF	Switch <b>must</b> be OFF for model 1601 barrier gate operator.
	Model 1602	ON	Switch <b>must</b> be ON for model 1602 barrier gate operator.
2	Multiple Input Memory ON/OFF Switch	OFF	<b>Normal setting.</b> Operator will respond to a single UP command, then require a DOWN command. <b>Operator will not accept multiple Up commands.</b> Operator will not accept the next UP command until the previous DOWN command is in progress.
		ON	Turns ON the multiple input memory option 1 or 2 (See switch 3). SW 1, switch 4 must also be on.
3	Multiple Input Memory Options (SW2, Switch 2 must be ON) (SW1, Switch 4 must be ON)	Option 1 (OFF Position)	Override a DOWN command – When the arm is in the up position for a vehicle passing through and the next vehicle's UP command is received, the operator will hold the arm up and wait for the next vehicle to clear the down loop before lowering the arm. The operator <b>will not count</b> multiple UP commands. Distance between access control device and barrier operator is a factor when using this option. Remote transmitters recommended for this option. See next page for more information.
		Option 2 (ON Position)	Override Multiple DOWN commands – The operator <b>will count</b> multiple UP commands received <b>during</b> an UP command and require a matching number of DOWN commands before lowering the arm. Distance between access control device and barrier operator is a factor when using this option. Remote transmitters <b>NOT</b> recommended for this option. See page 24 for more information.
4	Stop Arm Function	OFF	<b>Normal setting.</b> Arm <b>will NOT stop</b> DURING the down cycle.
		ON	Stop Arm Function – Arm <b>will stop</b> DURING the down cycle if a vehicle activates the down loop. An UP command will raise the arm, or the arm will continue down AFTER the down loop is cleared.
5	Reverse Delay	OFF	Arm reversal is delayed approximately .5 seconds when a reverse input from terminal 9 is received during the down cycle. (eg. non-contact sensor beam is blocked). Limited application use.
		ON	<b>Normal setting.</b> Instant Reverse – Arm reversal is delayed approximately .1 second when a reverse input from terminal 9 is received during the down cycle. (eg. non-contact sensor beam is blocked)
6	Arm Rotation Direction	OFF	<b>Normal setting.</b> Leave in OFF position.
7	Spare	OFF	<b>Normal setting.</b> Leave in OFF position.
8	Spare	OFF	<b>Normal setting.</b> Leave in OFF position.

# Option 1 - Override a DOWN Command sw2, Switch 3 OFF

Remote transmitters are recommended for this option.

**Basic operator UP/DOWN cycle:**  
**A.** Valid **UP** command from the access control device will raise arm.  
**B.** Vehicle activating and clearing the down loop will lower the arm.

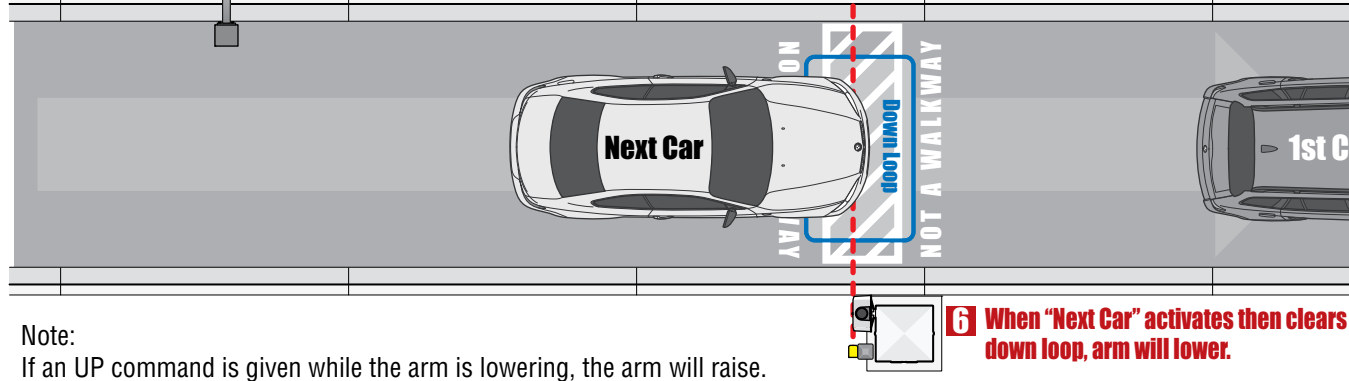
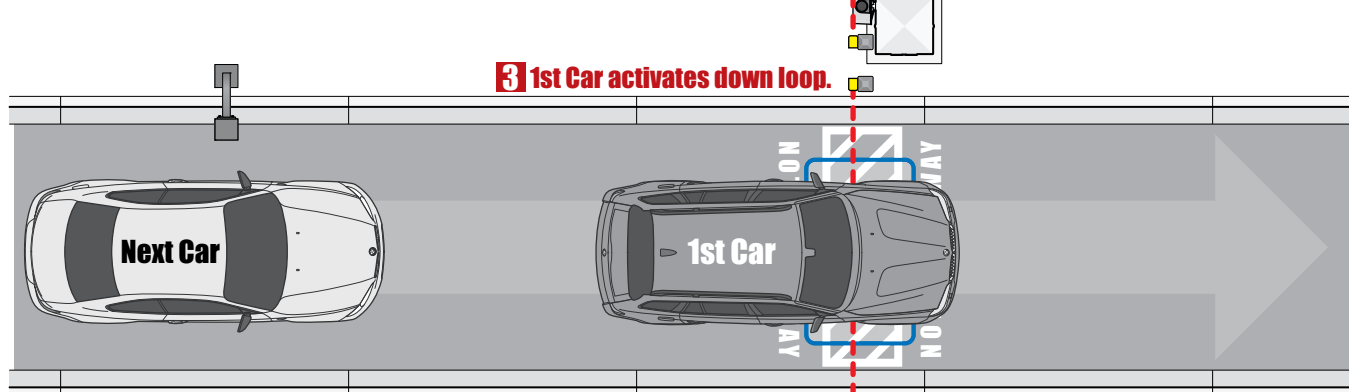
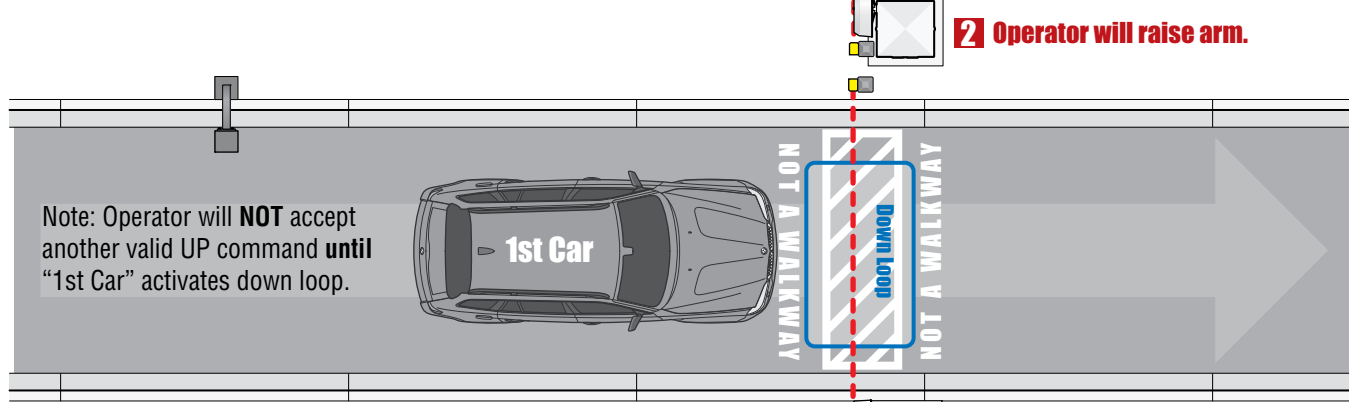
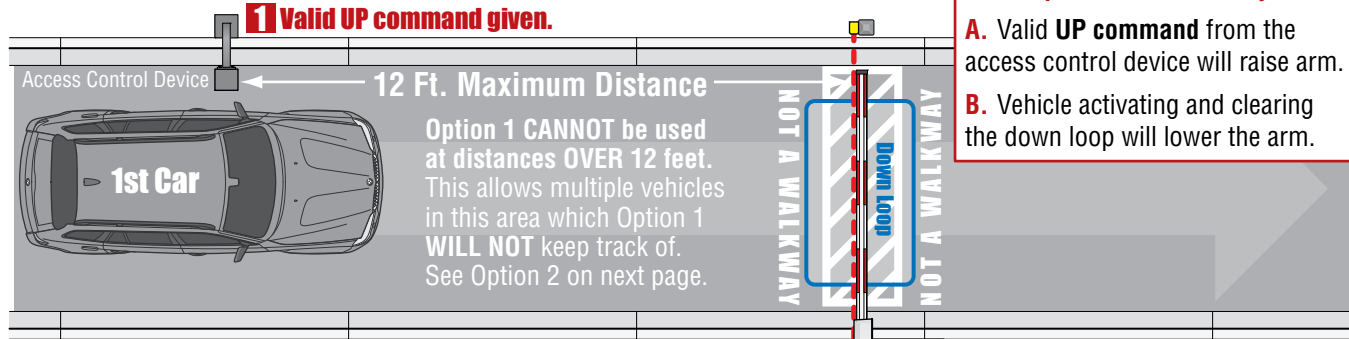

Note:  
 If an UP command is given while the arm is lowering, the arm will raise.

# Option 2 - Override Multiple DOWN Commands sw2, switch 3 ON

## Basic operator UP/DOWN cycle:

- A. Valid **UP** command from the access control device will raise arm.
- B. Vehicle activating and clearing the down loop will lower the arm.

This option allows the access control device and the barrier gate operator to have multiple vehicles in the area between them. The operator will count all the valid UP commands received and require a down loop activation for each one. The arm will lower only after the last vehicle activates then clears the down loop.

Remote transmitters are **NOT** recommended for this option because **one vehicle's remote** can accidentally be pressed **multiple times** which will get counted by the operator as multiple vehicles.

Note:  
If a valid UP command is given while the arm is lowering, the arm will raise.

### 1 Valid UP command given

Access Control Device

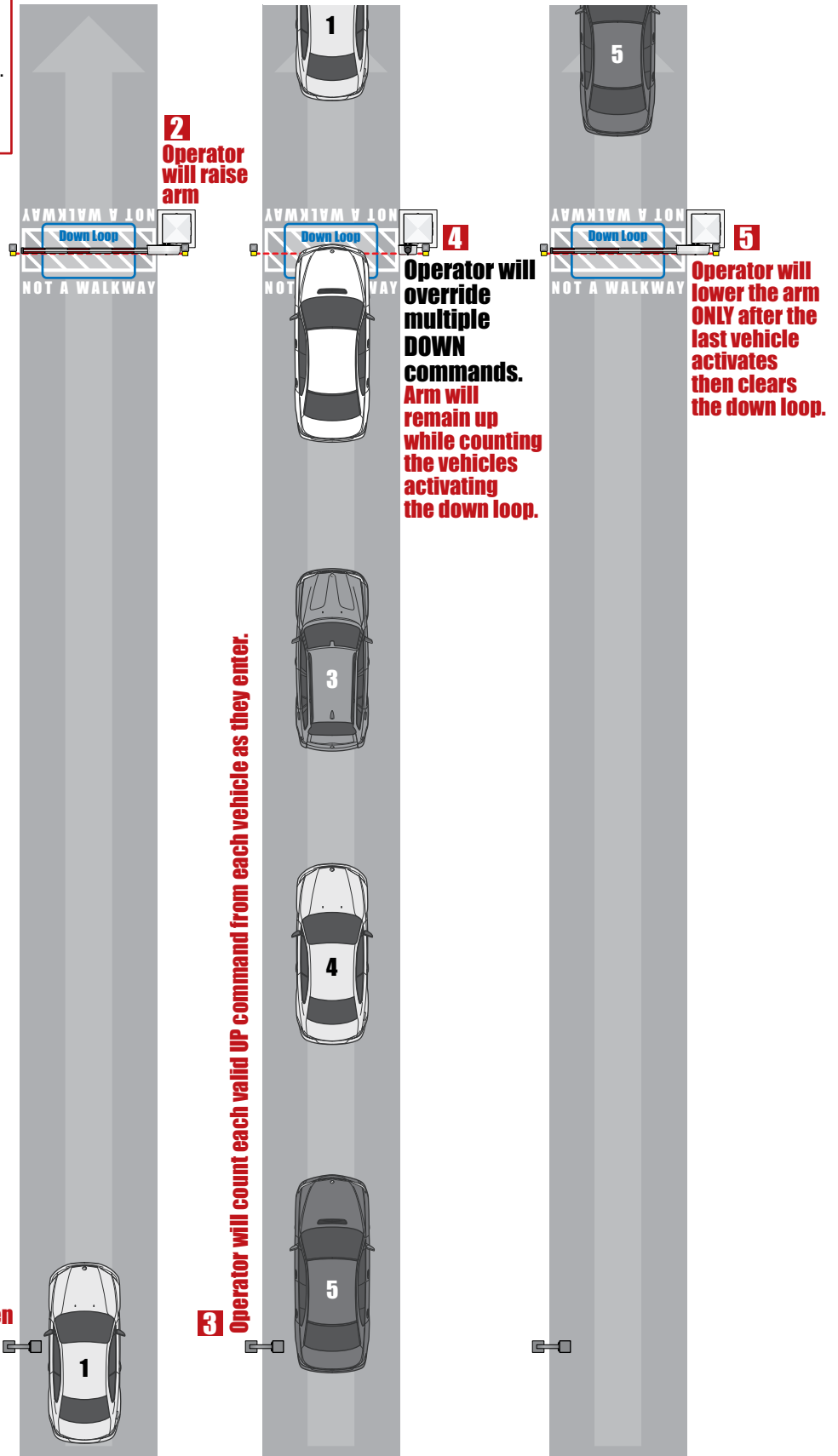

# 5.3 Reverse Arm UP and DOWN Positions

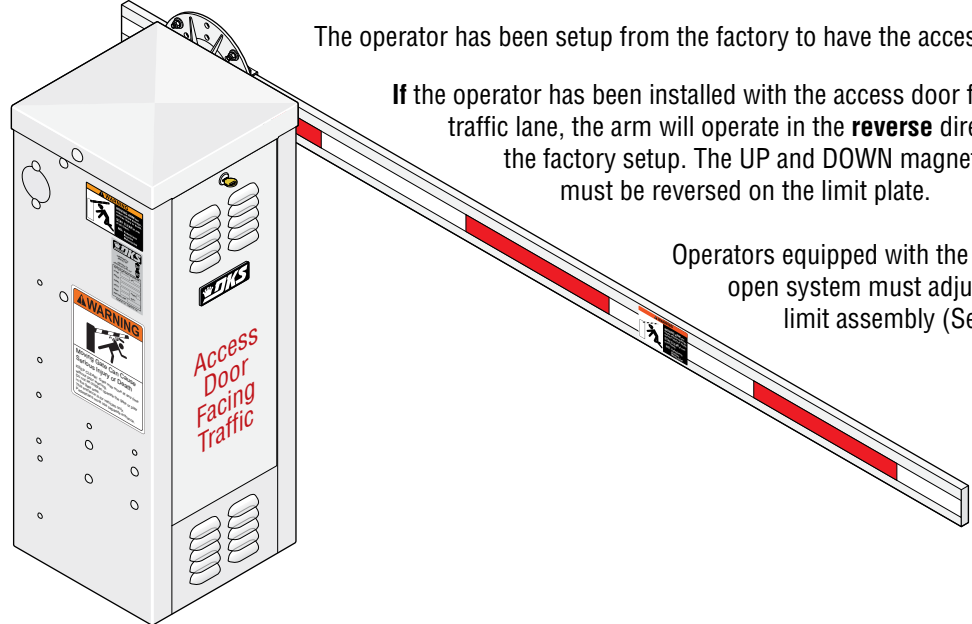

The operator has been setup from the factory to have the access door opposite the traffic lane.

If the operator has been installed with the access door facing the traffic lane, the arm will operate in the **reverse** direction from the factory setup. The UP and DOWN magnet positions must be reversed on the limit plate.

Operators equipped with the convenience open system must adjust the DC limit assembly (See below).

Note: Magnets can be removed from assemblies with 3 screws and flipped over to show or hide the white dot.

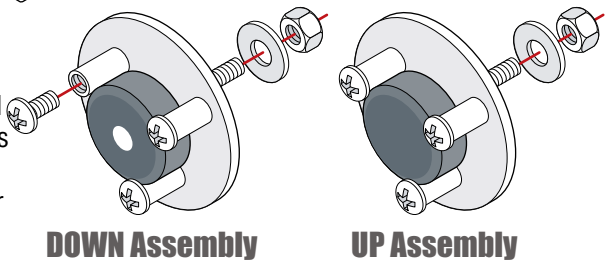

## Magnetic Limit Assemblies

Reverse the positions of the magnets on the limit plate. The white dot will be visible on the **DOWN** assembly magnet **ONLY**.

Be careful when reversing assemblies not to damage circuit board.

## UP Position of Limit Plate

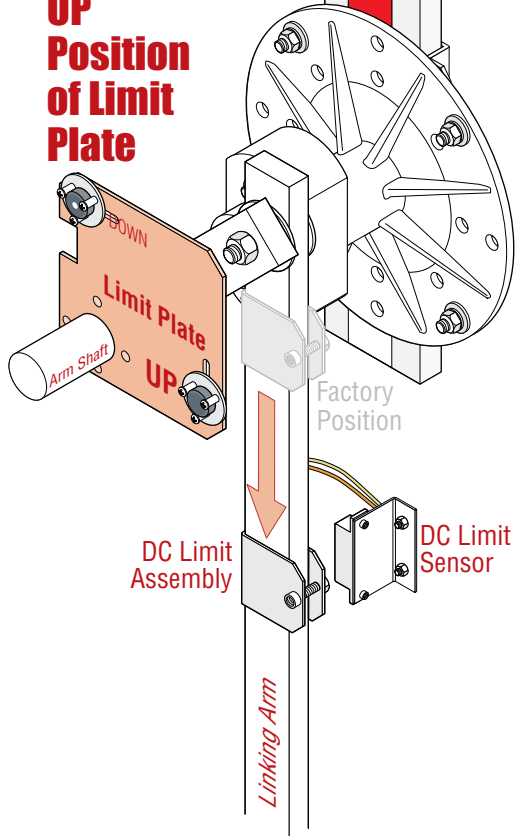

## DOWN Position of Limit Plate

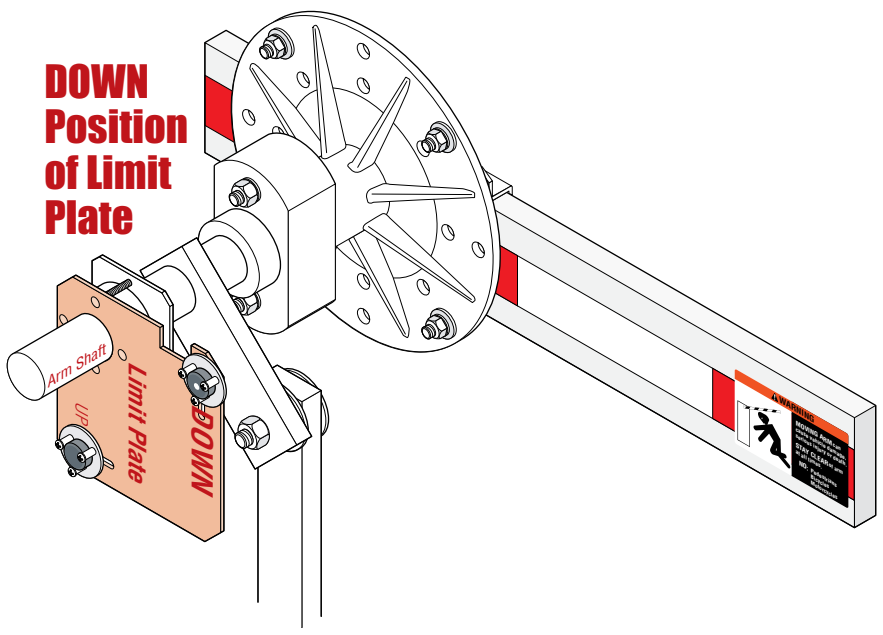

## Convenience Open System

Slide the DC limit assembly down the linking arm to align with the DC limit sensor when the arm is in the **UP** position.

**Note:** DC limit sensor is used to hold the arm in the UP position during an AC power failure.

## 5.4 Magnetic Limit Adjustments

The operator has been preset at the factory to rotate 90°. **No adjustments are necessary when used in a normal 90° setup.**

**If the arm needs to rotate less than 90°:**

- 1 Turn operator power **OFF**.
- 2 Set the DIP-switch SW 1, switch 3 to **ON**. This changes the rotation of the gearbox from 360° to 180° allowing the gearbox to rotate the arm less than 90°.  
Note: The arm will **always** cycle to 90° open with the 360° gearbox setting.

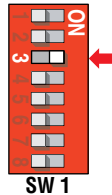

- 3 Loosen magnet limit assembly nuts and slide the assemblies to the desired **UP** and **DOWN** positions. Tighten nuts when desired positions are achieved.

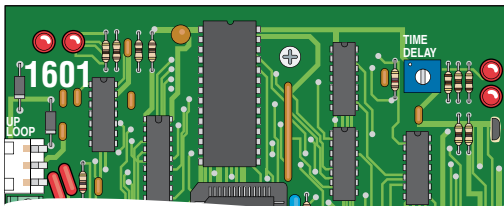

←UP Limit  
←DOWN Limit  
←Magnetic Limit Sensor

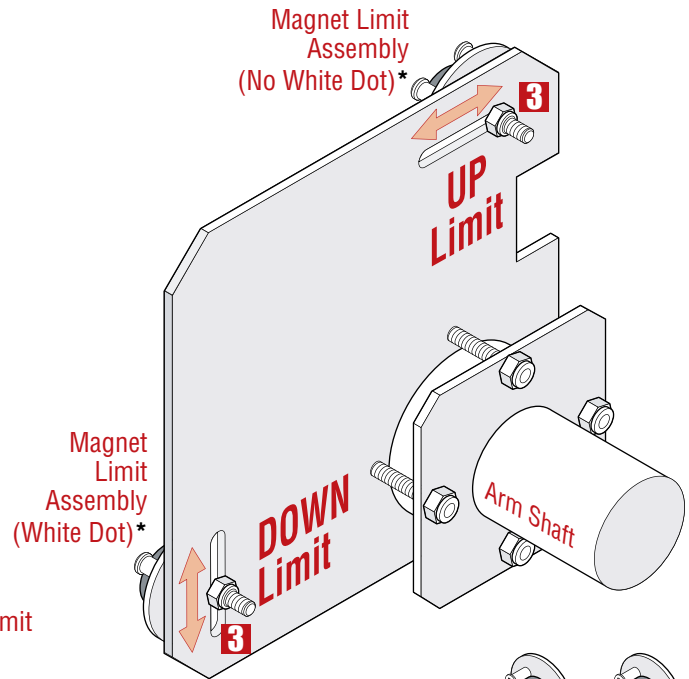

\*Factory Magnet Setting

## 5.5 Reverse Sensor

Reverse sensitivity adjustment will cause the barrier arm to reverse direction of travel should an object be encountered during the down cycle. The amount of force required for the arm to reverse direction depends on the reverse sensitivity potentiometer.  
**CAUTION: Keep pedestrians and vehicles clear of the arm zone while adjusting sensor!**

**While operator has AC power:**

- 1 Turn control switch to **UP**. Arm will rotate UP.
- 2 Turn control switch to **DOWN**. While arm is traveling down, rotate reverse sensor clockwise until the **reverse LED lights up** and the arm reverses direction. Rotate reverse sensor back counterclockwise approximately 1/8 turn.
- 3 Repeat the adjustment as needed to find a satisfactory setting.

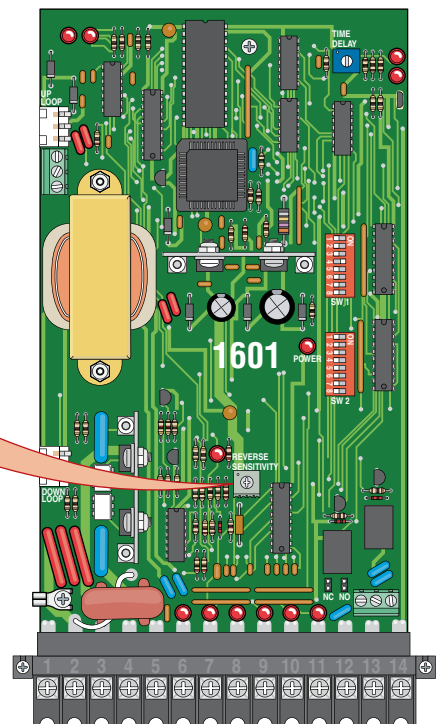
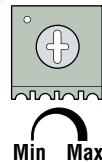



# 5.6 Manual Operation of the Arm

When a power failure occurs in an operator **WITHOUT** the convenience open feature with the arm (3-piece arm for the 1602) in the down position and the pathway needs to be open, **the arm MUST be unbolted from the hub with 4 bolts and removed to clear the pathway.** A manual release kit is offered from DoorKing to physically crank the arm up if desired (See below).

Operators **WITH** the convenience open feature can be set to **automatically open** the arm during a power failure.

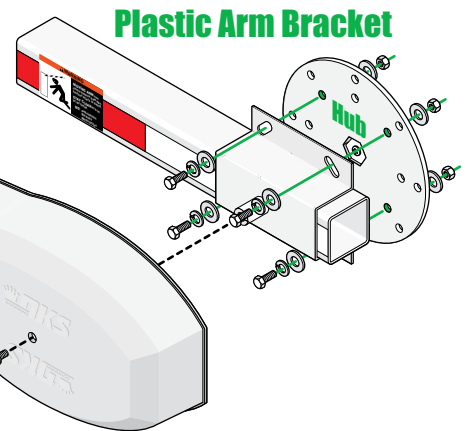
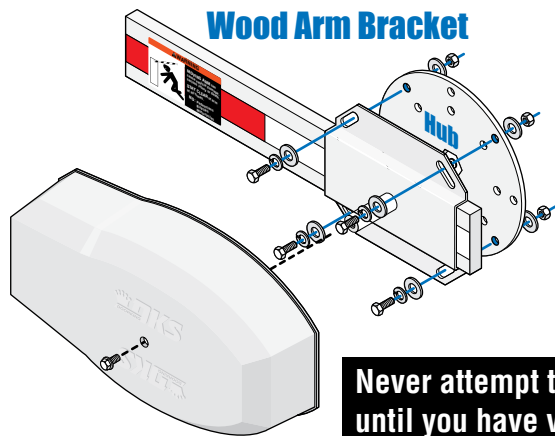

**Never attempt to remove arm until you have verified that power to the operator has been shut-off.**

## Standard Aluminum Arm OR Octagon Arms

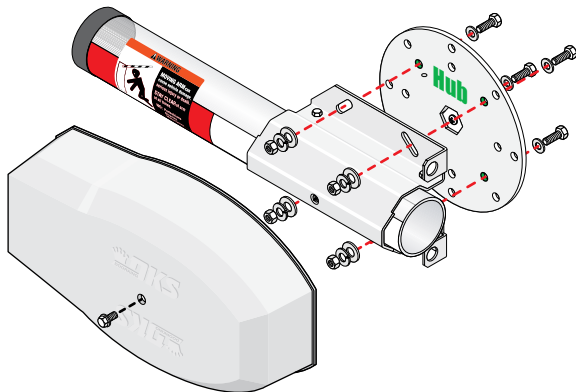

**Wire Harness Note:** Unplug wire harness **inside** operator and remove wire guard from operator housing **BEFORE** unbolting arm from hub when necessary.

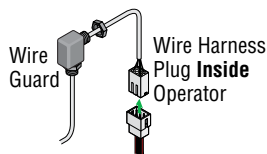

## Break-Away Aluminum Arm or Octagon Arms

**Note:** Unplug wire harness from **inside** the operator and remove wire guard from operator housing **BEFORE** unbolting arm from hub.

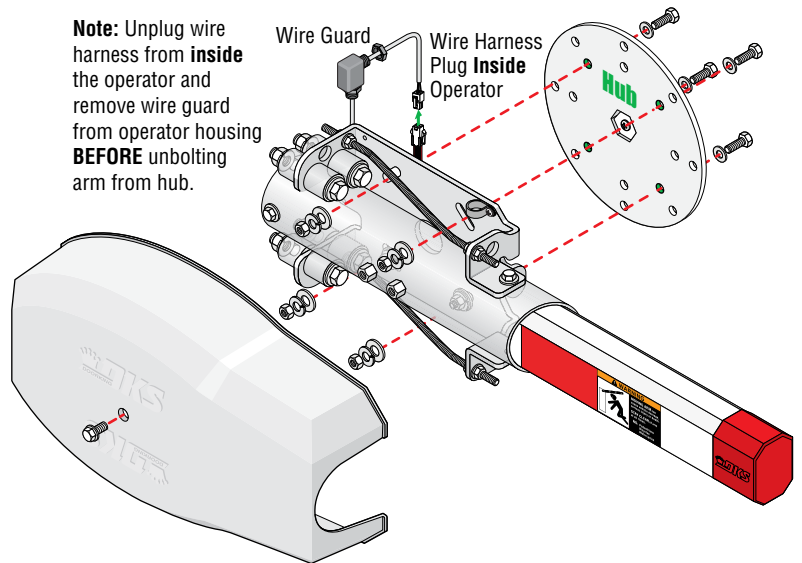

## “Optional” Manual Release Kit

DoorKing offers a kit designed to be installed on the 1601 or 1602 barrier gate operators **WITHOUT** the convenience open feature. It provides a crank tool to manually move the arm up or down. **DO NOT install on convenience open models.** For further information about this kit, refer to the instruction sheet provided with the kit (P/N 1601-270) or go to DoorKing’s web site at: [www.doorking.com](http://www.doorking.com)

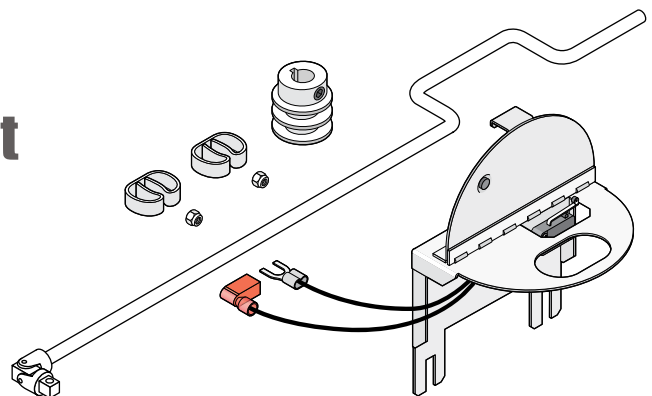

# SECTION 6 - OPTIONAL CONVENIENCE OPEN SYSTEM

The optional convenience open system installed in your vehicular gate operator is designed as a convenience enhancement only. It is not designed or intended to provide continuous gate operation during a power outage. Its sole purpose is to provide a method to open the vehicular gate to allow unimpeded traffic flow when the gate and access control system is without power. If your access control system requires 100% power backup and continuous operation when primary (AC) power has failed, a power inverter / backup system, such as DoorKing's Model 1000 is required.

- The convenience open system **cannot** provide continuous gate operation during a power outage.
- **This system cycles the arm to the open position one time only after AC power failure.**
- The convenience open system requires testing on a monthly basis to insure the batteries are fully charged and that the system is operational.
- The convenience open system uses two 12-volt, 3.0 amp-hour gel-cell batteries. These batteries should be replaced every two years on average, or sooner if required.
- Batteries are affected by temperature. Cold temperatures will reduce the effectiveness of the batteries. High temperatures will result in a shortened battery life.
- Batteries are not covered under warranty.

## 6.1 Circuit Board Settings and Descriptions

This convenience open system consist of a control board (1473-010), motor and power supply (batteries) providing a completely redundant drive system to open the barrier arm should a power outage occur. This system is not designed to maintain continuous barrier operation; rather it provides a convenient method to open the arm **once** during adverse conditions. **If continuous barrier and access control system operation is required, refer to the DoorKing Model 1000 Inverter / Backup Power System.**

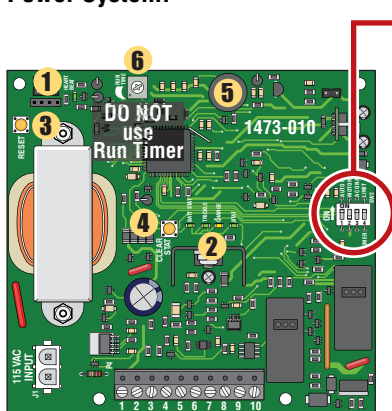

### DIP-Switches

Switch	Function	Setting	Description
1	Auto Open Operation After Power Outage	OFF	DO NOT USE. Manual Mode.
		ON	(Auto Mode) Apartment complexes, gated communities, etc.: Arm will <b>automatically</b> raise to the operator's UP limit position.
2	Motor Dir Motor Direction	OFF	Set so that the arm <b>opens to the UP direction</b> upon loss of AC power.
3	AC on ACT Restore Power Operation	OFF	DO NOT USE. Physical Input Required.
		ON	Auto: a 1-second pulse is <b>automatically</b> sent to the barrier gate operator input to restore normal operation again.
4	Timer-OFF Limit-ON Operator Type	Timer-OFF	DO NOT USE. "Run timer" is used and <b>MUST</b> be adjusted.
		Limit-ON	Operator limits are used to stop arm at UP position.

### 1 HEART BEAT LED

**Blinking:** Indicates board is operating normally.

### 2 Battery LEDs

#### BATT STAT LED

**2 Blinks:** Replace batteries.

**3 Blinks:** Battery level is too low.

**4 Blinks:** Batteries are not connected.

**5 Blinks:** Bad battery.

**6 Blinks:** Battery charge current exceeds maximum, possible shorted cell.

#### TRICKLE LED

**Steady Green LED:** Battery is fully charged and a trickle charge is being used to maintain a full charge.

#### CHARGE LED

**Steady Yellow LED:** Battery is being bulk charged.

**Blinking Yellow LED:** Battery is 90% of a full charge.

#### STAT LED

**3 Blinks:** Extreme temperature, charging suspended.

### 3 Reset Button

Press to reset board.

### 4 Clear Stat Button

Press and hold the **CLEAR STAT** button for 4 secs clears the battery replacement reminder counter and resets the beeper. LEDs will also indicate battery status.

### 5 Beeper

A beep every 20 seconds indicates that battery replacement is needed. Press and hold the **CLEAR STAT** button to reset the battery reminder beeper and clear the counter. LEDs will also indicate battery status.

### 6 Run Timer DO NOT USE.

**Operating Note:** Arm will cycle to UP position **automatically** (DIP-Switch 1 **ON**) during an AC power failure. Operator's DC limit sensor will stop and hold the arm in the UP position (DIP-Switch 4 **ON**). Operator will **automatically** return to normal operation once AC power has been restored (DIP-Switch 3 **ON**).

#### Initial Power Up Convenience Open Note:

The DC power is not present on the main circuit board until the **first** initial cycle.

# 6.2 DC System Wire Schematic

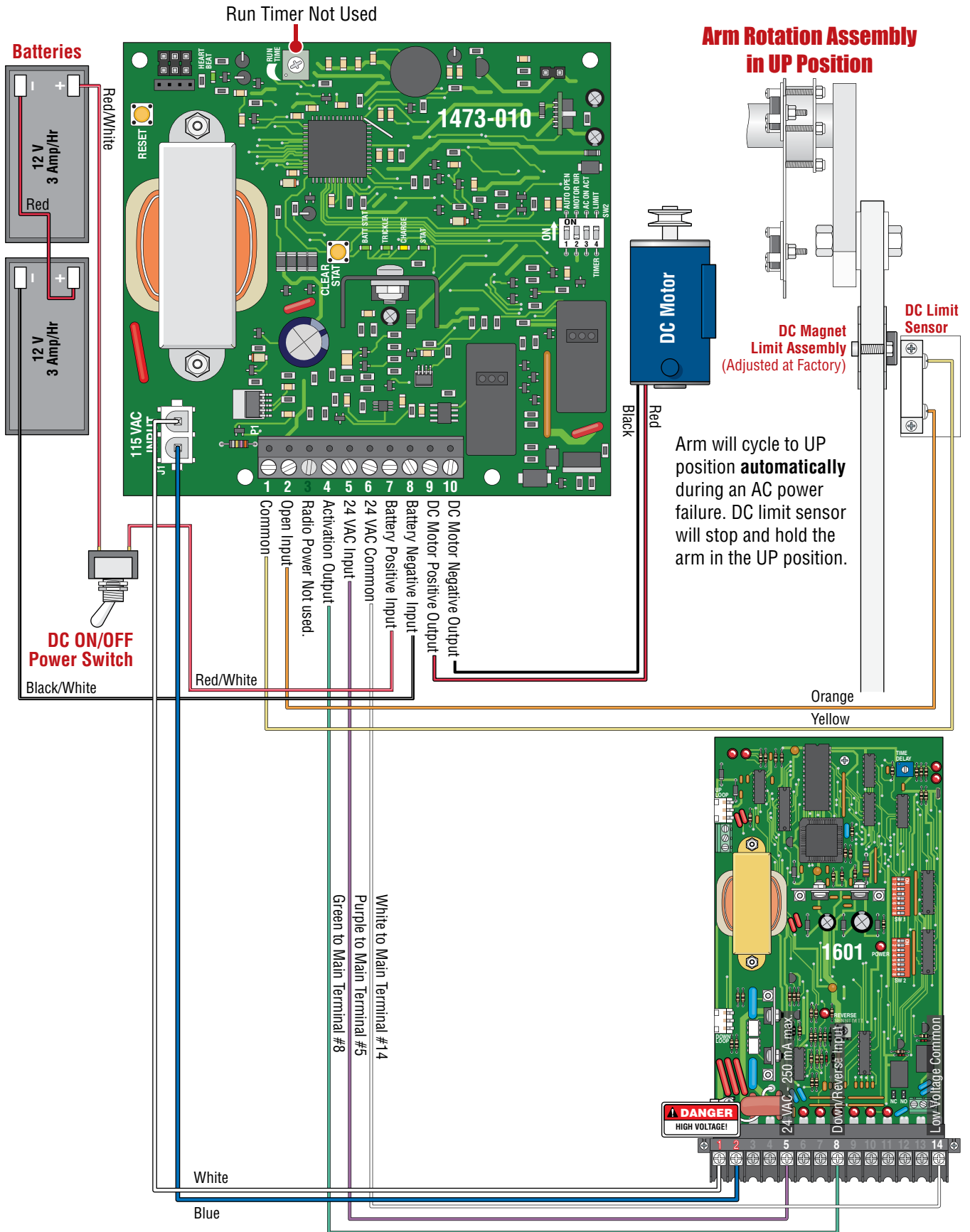

Arm will cycle to UP position **automatically** during an AC power failure. DC limit sensor will stop and hold the arm in the UP position.

# SECTION 7 - OPTIONAL ACCESSORIES

## 7.1 1601 Contact Sensor Installation (Reversing Edge)

In addition to the electronic reversing device (ERD) an electric reversing edge may be installed on **Wood** or **Round Aluminum** arms **ONLY** offering additional protection (Not provided).

### Contact Sensor Note:

A reverse edge is **NOT** to be used as a replacement, or in lieu of, in-ground loops or non-contact sensor (photozell) that protect vehicles passing underneath the barrier arm. A moving vehicle coming in contact with a downward moving barrier arm **WILL** result in **damage to the vehicle** and the barrier arm/reversing edge if **NOT** using in-ground loops or non-contact sensor (Photozell).

**1** Turn operator power **OFF**. Remove Cover.

**2** Position the mounting channel at the end of the barrier arm and secure to the bottom of the arm using self-tapping metal screws (not supplied). Slide the reversing edges into the mounting channels.

**3** Drill a 1/4-inch hole on the side of the operator housing beneath the operator arm shaft and not interfering with the internal components.

**4** Install a plastic grommet (Not supplied) in the 1/4" hole to protect the wire from chaffing on sharp metal edges.

**5** Secure the wire to the arm and hub using wire ties (not supplied). Leave a wire loop to allow the arm to rotate freely. Make sure wire does not rub against the cover when cycling.

**IMPORTANT:**  
Allow a loop in the wire for rotating arm.

**6** Typical connection of wires to terminals 9 and 14 without interfering with any of the operator's moving parts. Re-install cover.

To **6** Wiring **IMPORTANT:** Refer to your chosen reversing edge for wiring instructions

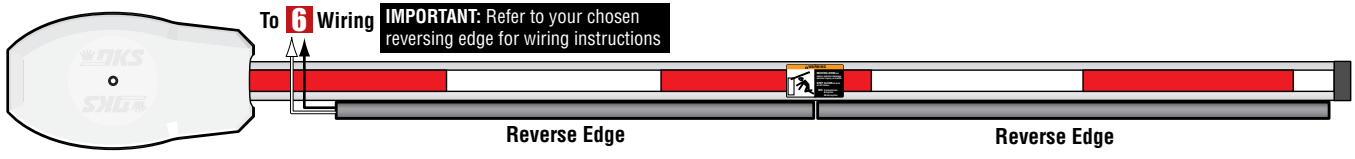
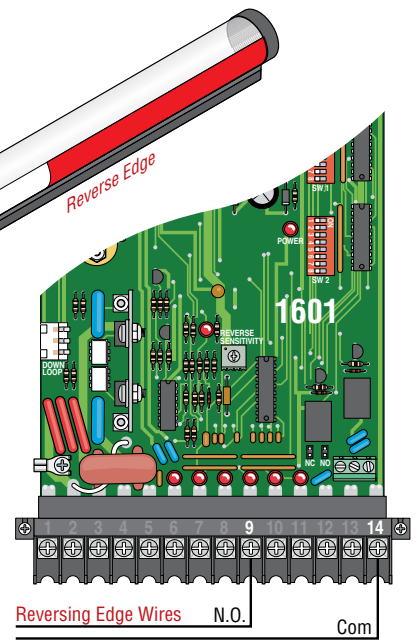

## 7.2 Additional Optional Accessories

“Optional” accessories offering additional features, available from DoorKing.

### LED Traffic Light

This kit is designed for the 1601 or 1602 barrier gate operators. The traffic signal is synchronized with the gate operator's up/down cycle. The red light stays on and only changes to green when the operator's arm is fully raised.

P/N 1603-221 - 6 Ft Cable with NO Post

P/N 1603-222 - 6 Ft Cable with 35" Post

P/N 1603-223 - 11 Ft Cable with 95" Post

For further information about this, go to DoorKing's web site at: [www.doorking.com](http://www.doorking.com)

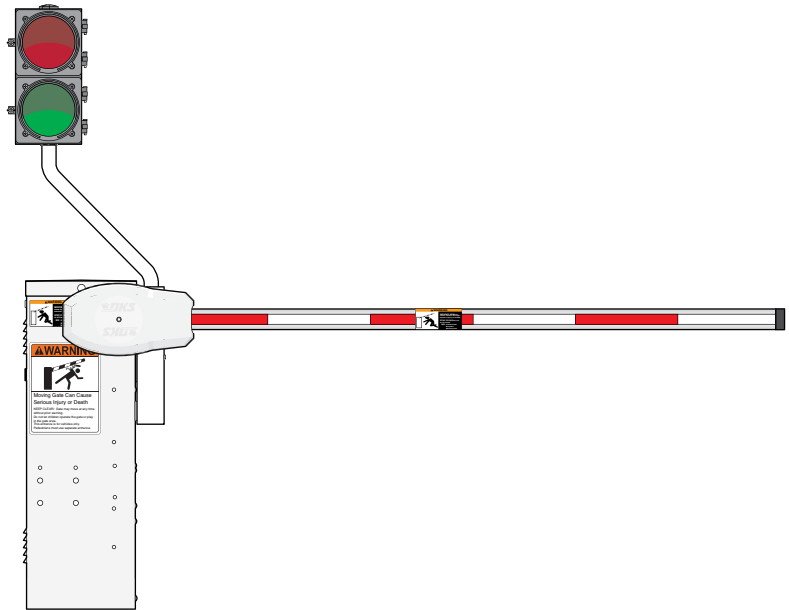

### Manual Release Kit

This kit is designed to be installed on the 1601 or 1602 barrier gate operators **WITHOUT the convenience open** feature. It provides a crank tool to manually move the arm up or down. **DO NOT install on convenience open models.** For further information about this kit, refer to the instruction sheet provided with the kit (P/N 1601-270) or go to DoorKing's web site at: [www.doorking.com](http://www.doorking.com)

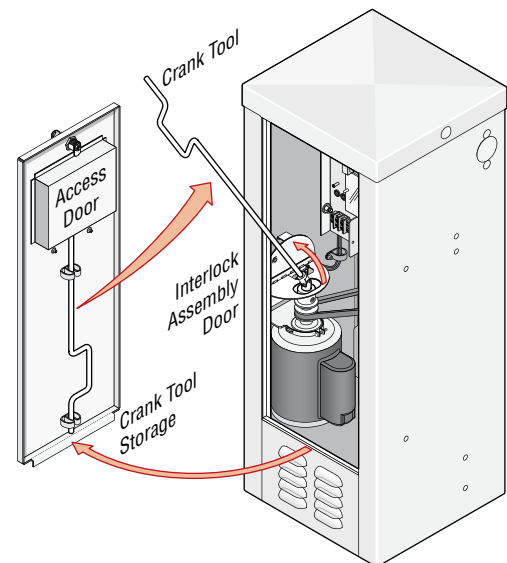

## 7.2 Additional Optional Accessories

“Optional” accessories offering additional features, available from DoorKing.

### Fan Kit

This kit is designed for the 1601 or 1602 barrier gate operators. It is recommended for hot humid climates to prevent heat and moisture build-up inside the housing (P/N 1601-093). For further information about this, go to DoorKing’s web site at:

[www.doorking.com](http://www.doorking.com)

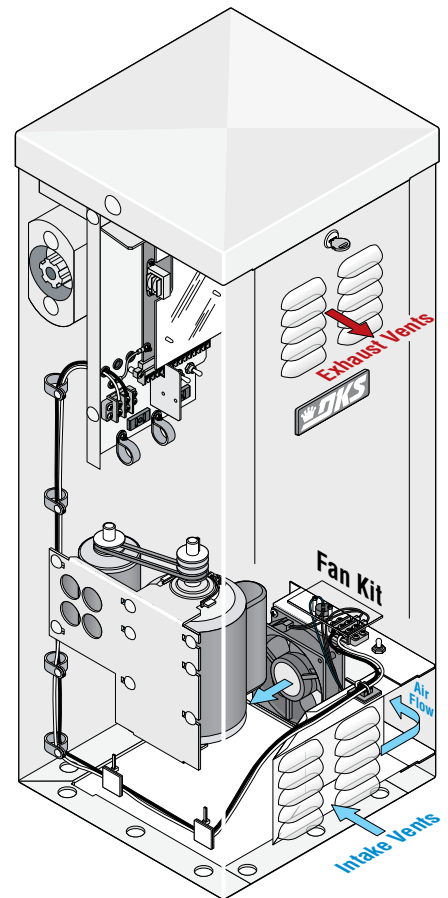

### Heater Kits

These kits are designed for the 1601 or 1602 barrier gate operators. For cold weather climates where temperatures routinely drop below 10°F (-12°C). A built-in thermostat will automatically control the temperature inside operator housing. There are different kits depending on the input power wire being used to power the barrier gate operator. For further information about these, go to DoorKing’s web site at: [www.doorking.com](http://www.doorking.com)

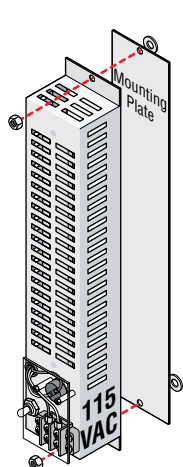

P/N 1601-092 - 115 VAC

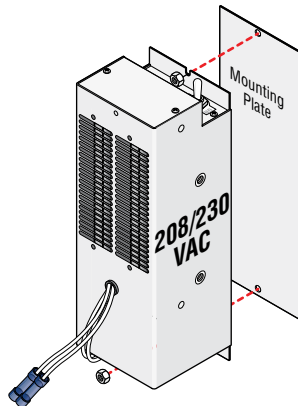

P/N 1601-197 - 208/230 VAC

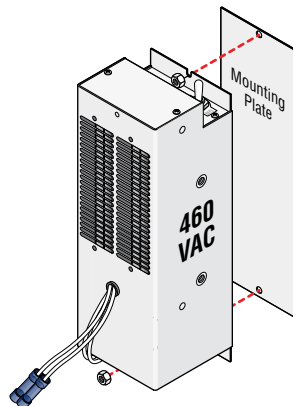

P/N 1601-198 - 460 VAC

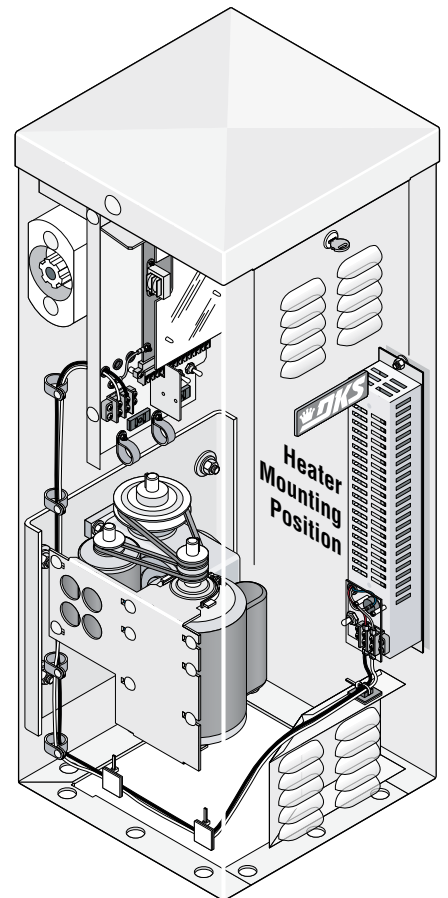

# SECTION 8 - MAINTENANCE AND TROUBLESHOOTING

Inspection and service of this gate operator by a qualified technician should be performed anytime a malfunction is observed or suspected. High cycle usage may require more frequent service checks.

## 8.1 Maintenance

When servicing the gate operator, always check any external reversing devices (loops, photo eyes, etc.) for proper operation. If external reversing devices cannot be made operable, do not place this operator in service until the malfunction can be identified and corrected.

**Always check the inherent reversing system when performing any maintenance. If the inherent reversing system cannot be made operable, remove this operator from service until the cause of the malfunction is identified and corrected. Keeping this operator in service when the inherent reversing system is malfunctioning creates a hazard for persons which can result in serious injury or death should they become entrapped.**



If replacing arm, make sure warning decal is on both sides of arm.

When servicing this gate operator, always turn power **OFF!!** If equipped with batteries, make sure battery power switch is **OFF**.

If gearbox requires oil, use only Mobil SHC-629 Synthetic Gear Oil. Do not completely fill gearbox with oil. Gearbox is full when oil completely covers inspection window.

Operator Component	Maintenance	Monthly Interval		
		1	6	12
<b>Warning Signs</b>	Check that warning signs are on <b>BOTH</b> sides of the gate area.	✓		
<b>Arm(s)</b>	Check for alignment, tightness and wear. Make sure warning decals are on operator and arm and easily visible.		✓	✓
<b>Drive Belt(s)</b>	Check for alignment, tightness and wear.		✓	✓
<b>ERD Reversing System</b>	Check that the arm reverses on contact with an object in closing cycle. Adjust the reversing sensor if necessary.	✓		✓
<b>Batteries (On select models)</b>	If operator is equipped with optional convenience open system, check the batteries for any leakage or loose connections. Batteries should be replaced every two years.	✓		
<b>Convenience Open System (Not on all models)</b>	If operator is equipped with optional DC open system, check to be sure the system opens the arm upon loss of AC power. Operator should resume normal operation when AC power has been restored.	✓	✓	✓
<b>Fire Dept.</b>	Check emergency vehicle access device for proper operation.	✓		✓
<b>Gearbox</b>	Check oil level and fill if necessary. Do not overfill.			✓
<b>Linkages</b>	Check internal linkages for wear. Inspect bushing for wear.		✓	✓
<b>Loop(s)</b>	Check all external ground loops for proper operation.	✓		✓
<b>Pulleys</b>	Check set screw for tightness.		✓	✓
<b>External Reverse Device(s)</b>	Check electric reversing edges and photocell for proper operation.	✓		✓
<b>Complete System</b>	Perform a complete system check. Include all reversing devices, loops, access system devices, Fire Dept. access devices, etc.			✓

## 8.2 Diagnostics Check

Have the following diagnostic tools available: VOM meter with minimum voltage memory or min-max range to check voltage and continuity. Meg-ohm meter capable of checking up to 500 megohms of resistance to properly check ground loop integrity.

A malfunction can be isolated to one of the following:

- Gate Operator
- Loop System
- Keying Devices

### Disconnect all external inputs to the circuit board terminal.

1. Use caution when checking high voltage areas: terminals 1 through 6, the motor capacitor and the motor.
2. Check the input indicator LED's. They should only come ON when a keying device (card reader, push button, etc.) is activated. If any of the input LED's are ON continuously, this will cause the gate operator to hold the arm up. Disconnect the keying devices one at a time until the LED goes OFF (see troubleshooting guide).
3. If the operator stops or holds open, check external entrapment protection devices for any shorts or malfunction.
4. A malfunction in a loop or loop detector can cause the gate operator to hold the arm up, or not detect a vehicle when it is present over the loop. Pull the loop detector circuit boards from the loop ports on the operator circuit board. If the malfunction persists, the problem is not with the loop system. For more information refer to the loop detector instruction sheet and the DoorKing Loop and Loop Detector Information Manual.
5. Check that there are no shorted or open control wires from the keying devices to the gate operator. If a keying device fails to open the arm, momentarily jumper across terminals 6 and 14 on the control board terminal. If the gate operator starts, this indicates that a problem exist with the keying device and not with the gate operator.
6. Check the supply voltage and batteries. A voltage drop on the supply line (usually caused by using wires that are too small) will cause the operator to malfunction. Batteries should be fully charged for proper operation, replace batteries every two years on average.

## 8.3 Troubleshooting

Symptom	Possible Solution(s)
Operator will not run. Power LED is OFF.	<ul style="list-style-type: none"><li>• Check that power to the operator is turned ON.</li><li>• Check for 117 VAC with a voltmeter at control board terminals 1 and 2. If voltage measures 0, check power supply to operator or check terminal strip. If voltage measures OK, replace control board.</li></ul>



## 8.3 Troubleshooting Continued

Symptom	Possible Solution(s)
Operator will not run. Power LED is ON.	<ul style="list-style-type: none"> <li>• Press <b>RESET button on BOTTOM of 1/2 HP motor for 1601 ONLY</b>. No reset button on 1HP motor.</li> <li>• Momentarily jumper terminal 6 to terminal 14. If input LED does not come ON, check terminal strip or replace control board. If LED does come on, go to the next step.</li> </ul> <p><b>Remove circuit board from the terminal strip and shutoff power to the operator:</b></p> <ol style="list-style-type: none"> <li>1 Momentarily jumper terminal 2 to terminal 3 (Caution – High Voltage). Momentarily turn power ON. The motor should run. Make sure power is OFF. Remove the jumper.</li> <li>2 Momentarily jumper terminal 2 to terminal 4 (Caution – High Voltage). Momentarily turn power ON. The motor should run. Make sure power is OFF. Remove the jumper.</li> </ol> <ul style="list-style-type: none"> <li>• If motor does not run in either or both steps above, bad motor, motor capacitor or wiring to motor.</li> </ul>
Arm rotates up, but will not rotate down.	<ul style="list-style-type: none"> <li>• Check LEDs on terminals 6, 7 and 9. Any of these ON will hold the arm in the UP position. This indicates a shorted input.</li> <li>• Check the LEDs on the loop detectors. Any ON will hold the arm in the UP position. Possible loop or loop detector problem.</li> <li>• If auto timer is not used (SW 1, switch 7 off ), check to be sure SW 1, switch 6 is in the ON position. This will cause terminal 6 to rotate the arm down when it is activated.</li> <li>• Check to be sure SW 1, switch 4 is ON. This will cause terminal 8 activation, then deactivation to rotate arm down.</li> </ul>
Down input / down loop will not rotate arm to down position.	<ul style="list-style-type: none"> <li>• Check to be sure, switch 4 is in the ON position.</li> <li>• Down input must be activated, and then deactivated to cause arm to rotate down.</li> </ul>
Loop detector LED is on continuously.	<ul style="list-style-type: none"> <li>• Activate the reset switch on the loop detector.</li> <li>• Decrease loop detector sensitivity.</li> <li>• Check loop wire for resistance to ground with meg-ohm meter. Should be 100 meg-ohms or higher. If less than 50 meg-ohms, replace loop wire.</li> <li>• Be sure loop lead-in wire is twisted at least 6 turns per foot.</li> <li>• Be sure all loop connections are soldered.</li> <li>• Replace loop detector.</li> </ul>
Loop detector LED never activates.	<ul style="list-style-type: none"> <li>• Increase loop detector sensitivity.</li> <li>• Check continuity of loop wire. Should be 0 ohms. If continuity check indicates anything other than 0 ohms, check all connections. Replace loop wire.</li> <li>• Move loop detector board to the other loop detector port on the control board, and then check loop operation. If loop detector still fails, replace loop board.</li> <li>• If loop detector operates OK in the other loop port, replace control board.</li> </ul>
Battery back-up system will not raise arm upon power outage.	<ul style="list-style-type: none"> <li>• Check that the back-up system toggle switch is in the ON position.</li> <li>• Check to be sure that the 1473-010 battery back-up control board switch settings are set as described in SECTION 6.</li> <li>• Check the batteries for proper voltage, replace if necessary.</li> <li>• Replace the 1473-010 back-up control board.</li> </ul>
Operator has intermittent functionality problems that vary.	<ul style="list-style-type: none"> <li>• The main terminal #5 250 mA power has been exceeded. Check total amp draw of connected device(s).</li> </ul>

## 8.4 Accessories Parts List

The following accessories are available for 1601 and 1602 barrier gate operators.

**Plug-In Loop Detector** - Plug directly into ports on circuit board simplifying wiring.

P/N 9410-010 - Single channel detector.

P/N 9409-010 - Two channel detector.

P/N 9411-010 - Single channel detector with aux relay. Controls arm lowering for vehicles but NOT for pedestrians.

P/N 9416-010 - Single channel low power draw detector

P/N 9415-010 - Dual channel low power draw detector

**Loop Wire** - XLPE insulation is available in 500 and 1000 foot rolls, available in Black, Blue and Red insulation.

**Loop Sealant** - P/N 2600-771 Asphalt P/N 2600-772 Concrete

**Manual Release Kit for the 1601 or 1602** - Installs on operators **WITHOUT** the convenience open. P/N 1601-270

**Meg Ohm Meter** - Checks the integrity of ground loops. P/N 9401-045

**Interconnection Cable** - Interconnection cable contains all the necessary wires to interconnect primary / secondary operators.

Cable length: 30 ft. - P/N 2600-755 40 ft. - P/N 2600-756 50 ft. - P/N 2600-757

**High Voltage Kit** - Alter the input AC voltage on a 115 VAC 1601/1602 to 208, 230, 460 or 575 VAC. P/N 2600-266

**Reverse Edge** - Installs on the bottom of a **ROUND** aluminum or wood arm **ONLY**. P/N 8080-260

**Photocell** - Prevents arm from lowering on vehicles or pedestrians.

DoorKing Model 8080-057 Retro-Reflective Photocell

Miller Edge Reflective-Guard Model RG

Miller Edge Prime-Guard Model PG

EMX Industries Model IRB-MON

EMX Industries Model IRB-RET

Omron Model E3K-R10K4

Seco-Larm Model E-936-S45RRGQ

Seco-Larm Model E-960-D90GQ

**Manual Gate Control Toggle** - Allows user to manually operate gate arm. Fits inside single-gang electrical box. P/N 1200-017

**Time Clock** - 7 day clock, used to automatically open gate at pre-set time, fits inside operator. P/N 2600-791 7 day clock

**Surge Devices** - Helps prevent circuit board failure caused by lightning strikes and power surges.

P/N 1879-080 - High Voltage P/N 1878-010 - Low Voltage

**Replacement Battery** - Convenience open system. P/N 1801-009 (2 required)

**Speed Bump** - Prefabricated 6-foot speed bump reduces traffic speed through gate system. P/N 1610-150

**115 VAC Heater Kit** - Thermostatically controlled heater for cold environment.

**Note:** This heater kit only works with a 115 VAC Input power wire on the barrier gate operator. P/N 1601-092

**208/230 VAC Heater with Fan Assembly Kit** - Thermostatically controlled heater and fan for cold environment.

**Note:** This heater kit only works when installing a High Voltage Kit with 208 or 230 VAC Input power wire on the barrier gate operator.

P/N 1601-197

**460 VAC Heater with Fan Assembly Kit** - Thermostatically controlled heater and fan for cold environment.

**Note:** This heater kit only works when installing a High Voltage Kit with 460 VAC Input power wire on the barrier gate operator. P/N 1601-198

**Fan Kit** - Thermostatically controlled fan for hot humid environments. P/N 1601-093

**LED Traffic Light (Red, Green)** - Manage the traffic flow with LED red-green lights. Bolts onto the 1601 or 1602 operator.

P/N 1603-221 - 6 Ft Cable with NO Post

P/N 1603-222 - 6 Ft Cable with 35" Post

P/N 1603-223 - 11 Ft Cable with 95" Post

**Gate Tracker™** - Optional control board allows the barrier gate operator to report activity to a companion 1830 series access control system.

**1601 arm kit part numbers are located on pages 2 and 3.**

**1602 arm kit part numbers are located on pages 4 and 5.**

# 1/2 or 1 HP 115 VAC

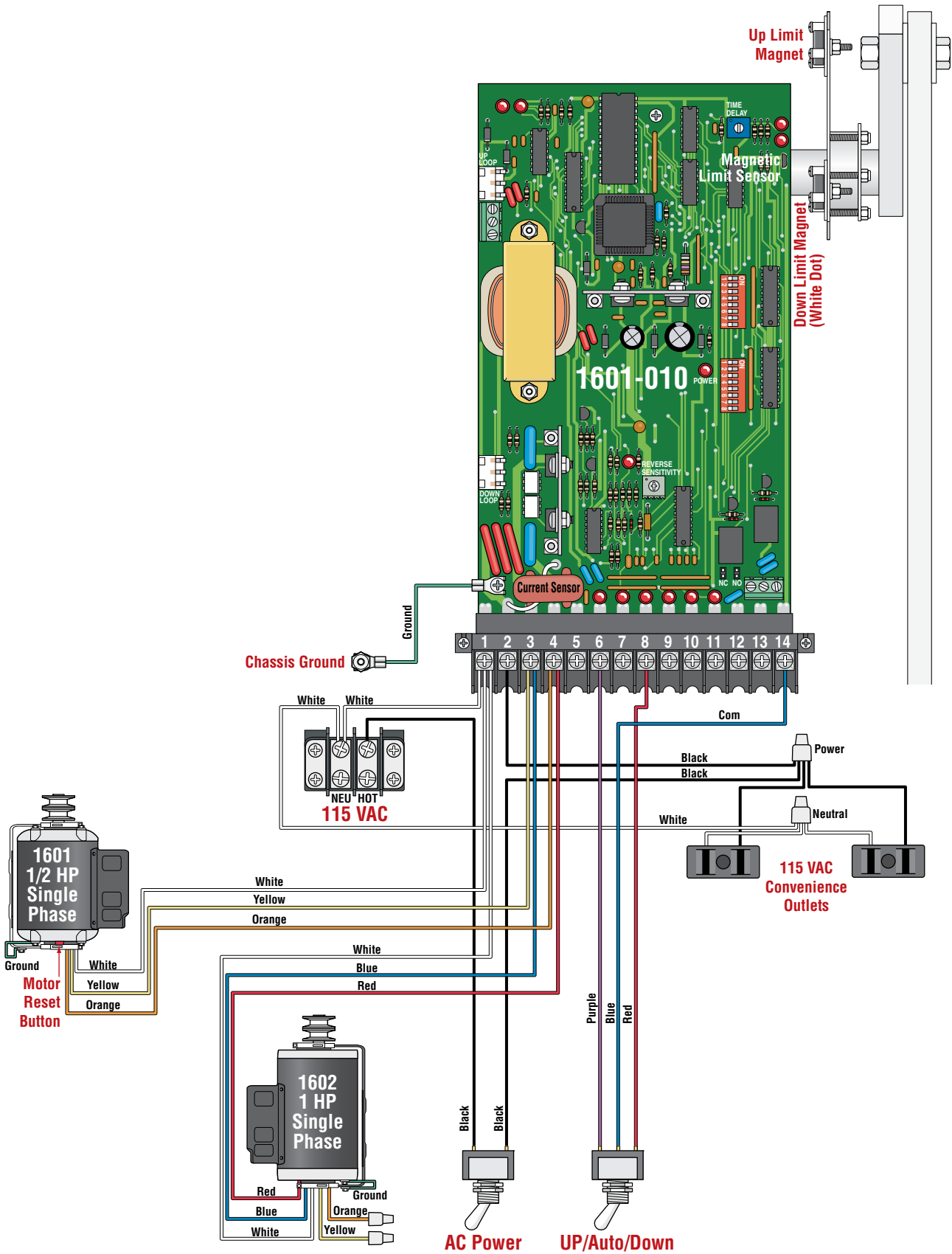

# 1/2 or 1 HP 115 VAC / Convenience Open

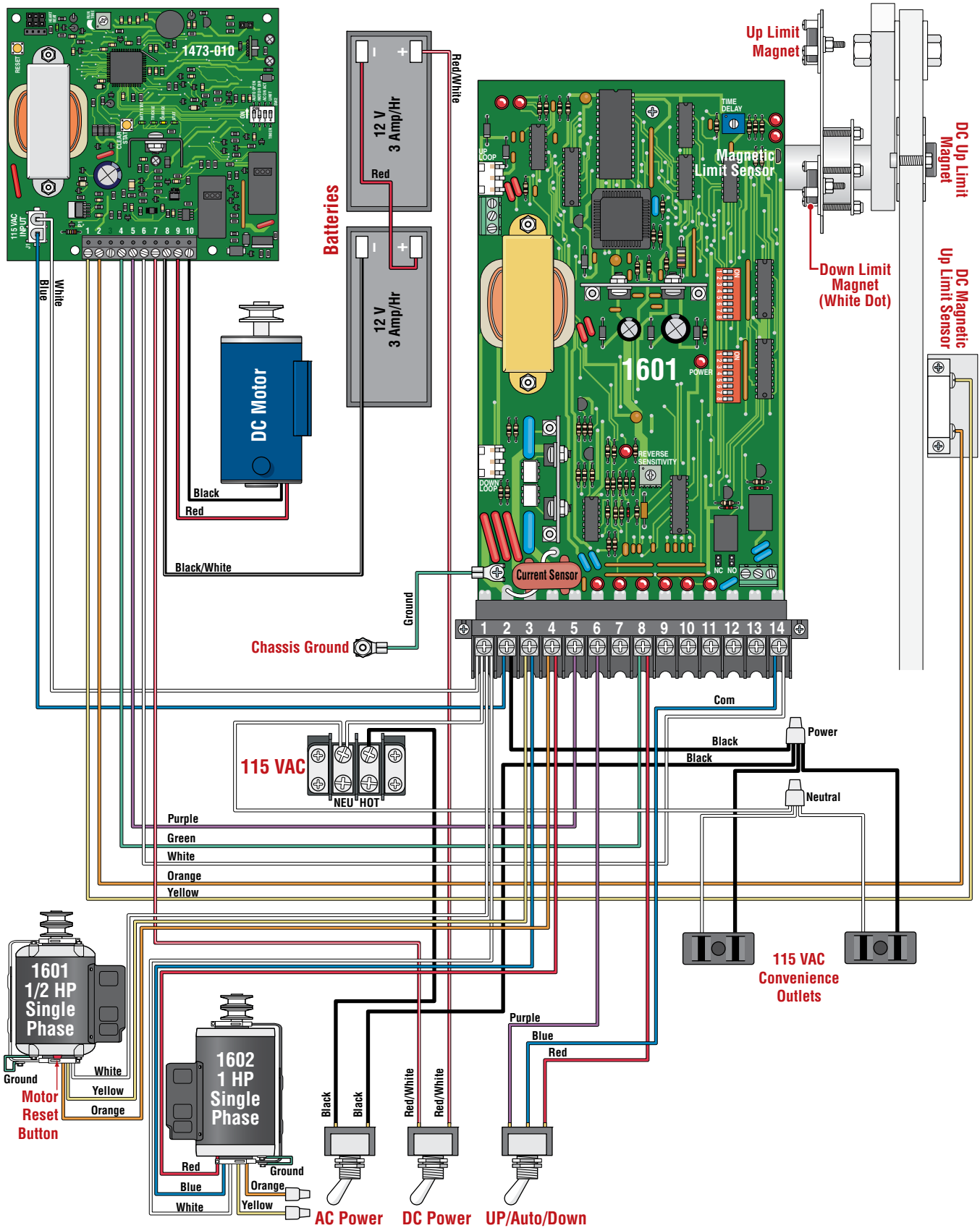



# Installation/Owner's Manual

# 1601 / 1602

## Barrier Gate Operator

Use this manual for circuit board 1601-010 Revision W or higher.

1601-065-U-4-22

**THIS PRODUCT IS TO BE INSTALLED AND SERVICED BY A TRAINED GATE/DOOR SYSTEMS TECHNICIAN ONLY.**  
Visit [www.doorking.com/dealer-locator](http://www.doorking.com/dealer-locator) to find a professional installing and servicing dealer in your area.

**Read all safety instruction pages before installing and operating this product**



[www.doorking.com](http://www.doorking.com)

DoorKing, Inc.  
120 S. Glasgow Avenue  
Inglewood, California 90301  
U.S.A.

Phone: 310-645-0023  
Fax: 310-641-1586